

**PRODUCT DATA SHEET****MODEL: 8005-952-490****SPECIFICATIONS:****MODEL NUMBER:** 8005-952-490**PUMP DESIGN:** Positive Displacement 3 Chamber Diaphragm Pump**CAM:** 2.5 Degree**MOTOR:** Permanent Magnet, P/N 11-147-10**VOLTAGE:** 24VDC Nominal**PRESSURE SWITCH:** None**LIQUID TEMPERATURE:** 180 Degrees Fahrenheit (82 Degrees Centigrade) Max.**PORTS:** 3/8"-18 NPT Female**MATERIAL OF CONSTRUCTION:****PLASTICS-** Nylon**VALVES-** EPDM**DIAPHRAGM-** Santoprene**FASTENERS-** Stainless Steel**NET WEIGHT:** 4.75 Lbs (2.15 Kg)**DUTY CYCLE:** Continuous (See Temperature Rise Chart)**APPROVALS:** NSF Listed**TYPICAL APPLICATIONS:** R.O. Booster Pump**BYPASS:** 100 PSI**DIMENSIONS:**

TEMPERATURE RISE

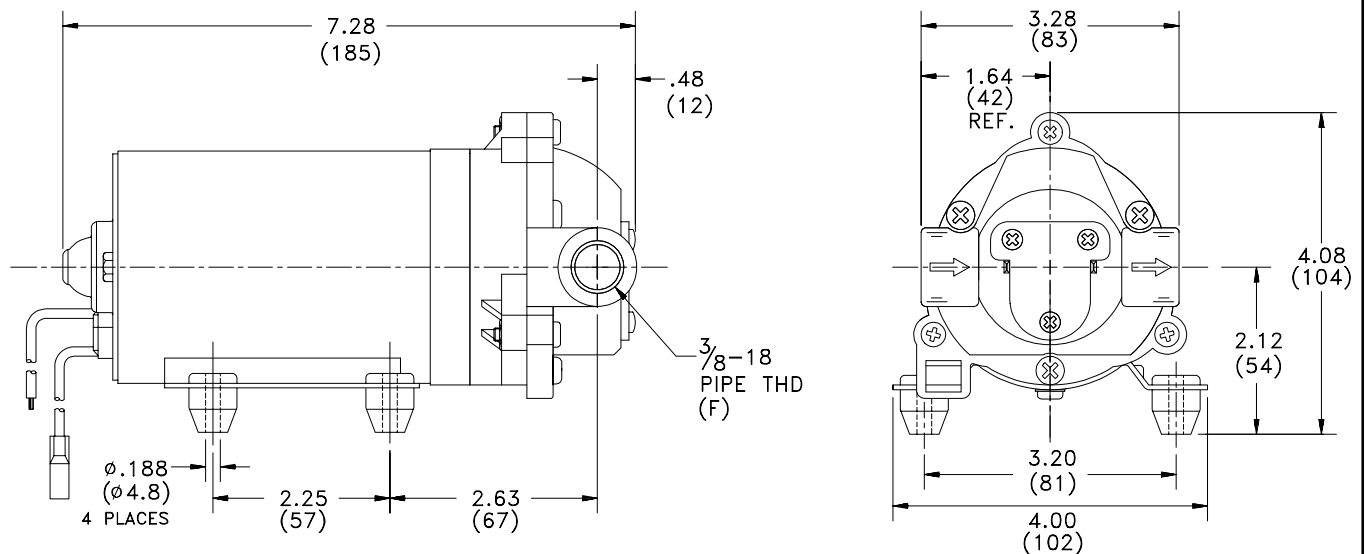
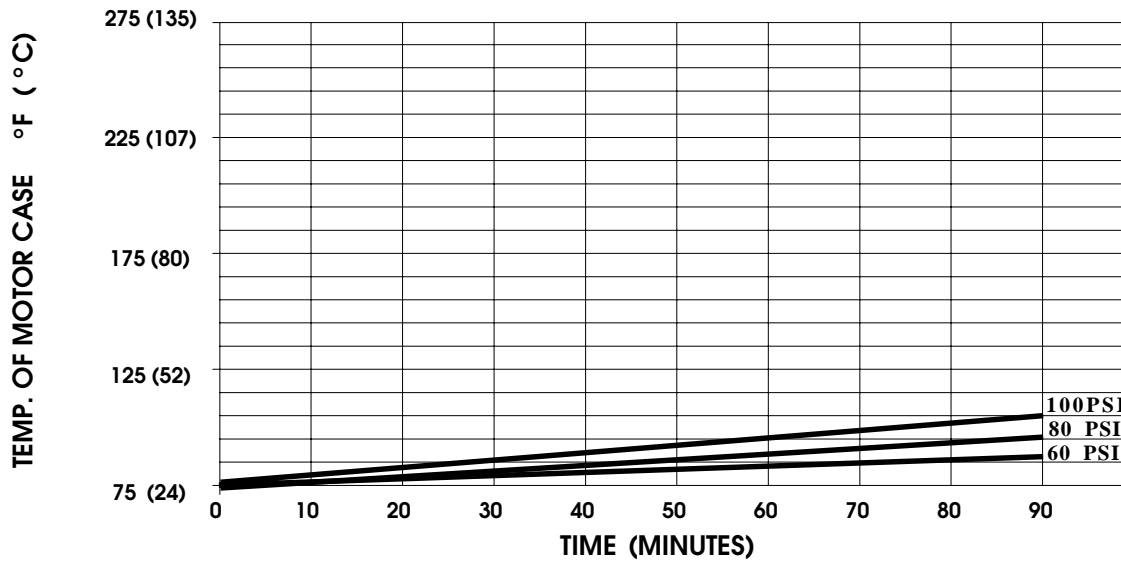

THIS GRAPH IS FOR USE AS A DESIGN GUIDE. IT IS BASED ON RUNNING CONTINUOUSLY WITH AN AMBIENT TEMPERATURE OF 73° F IN STILL AIR.

TYPICAL PERFORMANCE

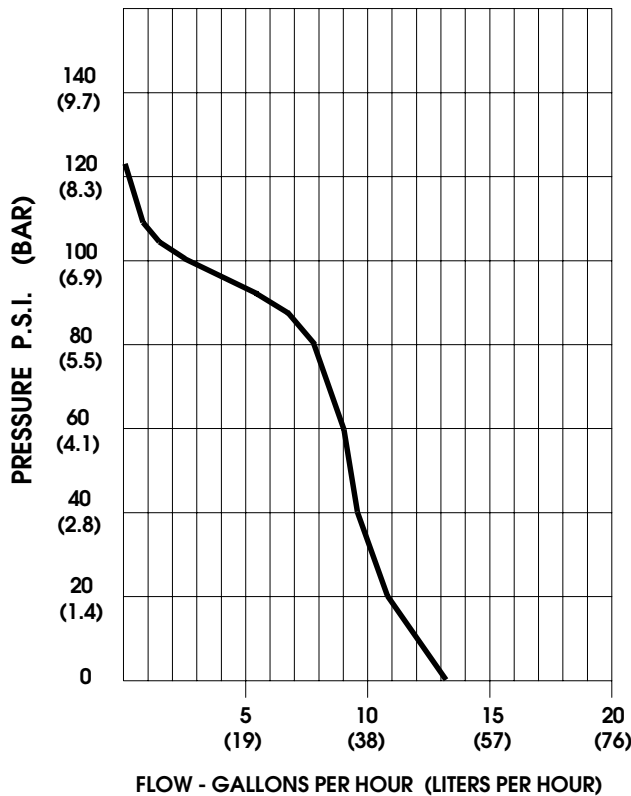

PRESSURE (PSI)	FLOW (GPH/LIT)	RPM MIN/MAX	CURRENT (AMPS)	VOLTAGE (VOLTS)
OPEN	13.2/50	415/425	0.14	24 VDC
10	11.4/43	405/410	0.18	"
20	10.8/41	385/395	0.23	"
30	10.2/38	365/380	0.28	"
40	9.6/36	345/365	0.34	"
50	9.3/35	325/345	0.39	"
60	9.0/34	305/335	0.44	"
70	8.4/32	285/325	0.48	"
80	7.8/29	265/310	0.53	"
90	7.2/27	250/300	0.58	"
100	2.4/9	225/290	0.64	"

-SPECIFICATIONS SUBJECT TO CHANGE WITHOUT NOTICE.

For technical advice or service please take your pump into your local pump service center.

To order pump or parts or for pricing please go to the following links :

[Shurflo Pumps Home >>](#)

[Shurflo Pumps stock list >>](#)