

17000 and 27000 Pump Series Technical Guide

Identification



**P1710X, P1710A,
P1726X, P1732X
& P1732A**



**P1716X, P1722X,
& P173**



P1719X



**P1727X, P1727A,
P1730X, P1730A, P1731,
and P1733X**



P176X



P2701X

Assembly / Disassembly Instructions

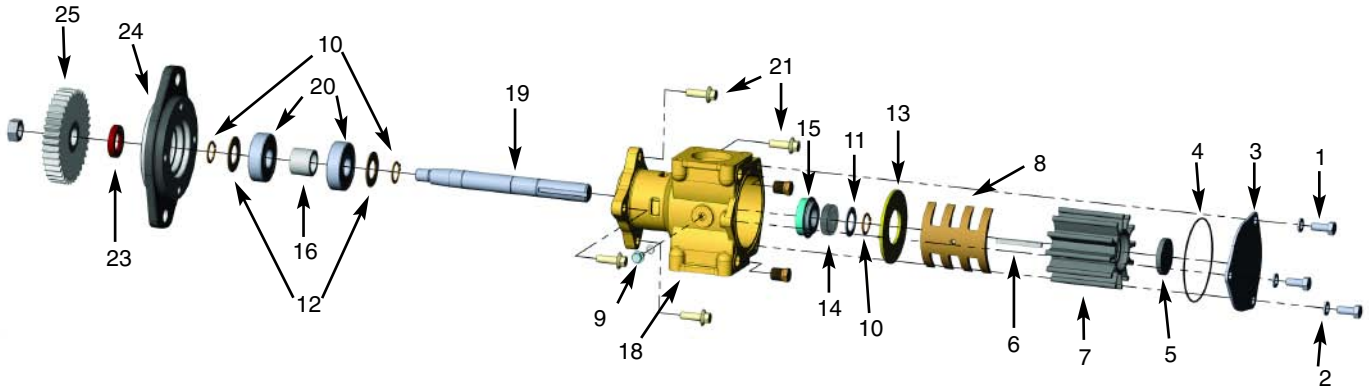

The following assembly/disassembly procedures apply to all 17000 Series pumps. Deviations from pump to pump are primarily a result of different methods of drive and mounting. Pump model numbers can be found stamped into the cover plate of the pump.

Disassembly:

- A. Remove the three bolts (1) and lock washers (2) from the pump cover (3). The cover and o-ring (4) are now free. The impeller end cap (5) can be pried off with a screwdriver. Normally, impellers (7) can be removed by using the 23631 impeller puller (or 3/4" – 16 bolt) for the 17000 threaded impeller, the 24412 impeller puller (or M16 x 1.5 bolt) for the 27000 threaded impeller, or by using two pair of pliers to grip two of the impeller's vanes on opposite sides of the impeller. A penetrating lubricant will help loosen a stuck impeller. Also, rotating the shaft by hand may help free the impeller. The 3/16" key (6) will also be removed at this time.
- B. Remove any pulleys or drive gears (25) from the drive shaft. For tapered shaft models (all models except P173, P1719, and P2701), it is necessary to remove the shaft nut and pull the gear or pulley with a puller. For models with pressed on gears (P173), two threaded holes are provided in the gear. An appropriate puller may be attached to these two holes to remove the gear from the shaft. The drive hub on the P2701 pump must be removed with a bearing puller.
- C. Most models will be equipped with a flange adapter (24). The flange adapter is held to the pump body by two socket head cap screws (21), either 3/8" or 10mm, depending on the model. The screws are removed by using a hex socket wrench. More current models are mounted with four 8mm flange hex head bolts. The adapter is then removed. If the lip seal (23) in the adapter requires replacing, it can be pressed out at this time.
- D. The cam (8) and cam screw (9) are removed. The internal wear plate (13) will drop out. The retaining ring (10), washer (11) and seal seat (14) are then removed.
- E. From the ball bearing end, the internal snap ring (17) must be removed on models P171 through P176, and P2701. Later models have extended bearing assemblies and are held together by means of the flanged adapter. The shaft/bearing assembly (19) is pressed out of the body from the impeller end of the housing removed from the engine end of the pump. The two external snap rings (10) are removed from the shaft (19) along with the bearing washers (12), permitting removal of bearings (20). The mechanical seal (15) may now be pressed from the bearing side of the housing (18).

Warning: If a shaft/bearing assembly exists for the particular model that is being repaired, do not try to build the shaft/bearing assembly from the individual parts, but instead purchase the entire assembly. Due to extremely tight tolerances, special assembly procedures for this assembly must be followed to prevent galling and subsequent leakage in the oil seal area of the pump.

Reassembly:

- A. Press mechanical seal (15) into housing (18) with the grey silicon carbide or black carbon seal face toward the impeller.
- B. On all older model pumps with mounting adapters, the lip seal (23) will have to be replaced prior to replacing the flange adapter (24). Care should be taken to insure proper alignment of the lip seal to the adapter and that the lip seal is uniformly pressed to prevent distortion. The metal backing ring of the lip seal goes toward the pump and away from the engine.
- C. Skip this step if the entire shaft/bearing assembly is available for the particular model that is being repaired. Install external snap ring (10) on shaft (19). Next, place washer (12), bearing (20), bearing spacer (16), second bearing (20) and washer (12) and secure with the second external snap ring (10). The bearings will have to be pressed on from the pulley/gear end. Note that it is extremely important to properly align the bearings to the shaft prior to press, otherwise the possibility exists of galling the shaft in the area of the lip seal. This completes the bearing and shaft assembly.

Assembly / Disassembly Instructions (continued)

- D. Press the bearing and shaft assembly into the housing (18). In applicable pump models, replace the internal snap ring (17). On newer model pumps, the bearings will be flush to the end of the housing or slightly protruding, and will be retained with the flange adapter (24). The adapter (24) may be reassembled to the pump housing (18) at this time with the two or four bolts (21) as applicable. The use of Loctite #262 or equivalent is recommended on the adapter bolts. Torque the adapter bolts to 18 ft-lbs.
- E. The seal seat (14) is now installed from the impeller end of the housing. The grey silicon carbide or white ceramic seat should be placed against the grey silicon carbide or black carbon seal face of the mechanical seal (15). Care must be taken to remove all burrs from the keyway to prevent cutting of the rubber cup. If possible, a half thickness key can be used to assist in assembly. In pressing the ceramic and boot, a pusher should be used with a diameter only slightly greater than the shaft diameter (.80"). Soapy water or a lubricant from a seal manufacturer may be used in assembly. Oil or grease must not be used as it will prevent the rubber cup from properly gripping the shaft. The seat and cup are pressed just beyond the external/snap ring groove. The seat should be inspected to insure that the cup did not become partially dislodged during the press procedure. The washer (11) and external snap ring (10) are then installed.
- F. The internal wear plate (13) is dropped in place, anti-rotation pin aligned with the cast slot in the bottom of the housing. The cam (8) is reinstalled and secured with the cam screw (9). Older model cam screws were sealed by means of a nylon washer requiring Permatex or other sealant to seal the cam screw. The cam screw should be inspected to insure that it does not protrude below the cam. This condition is possible if the nylon seal is badly deformed or if a substitute screw is used. Should the screw protrude beneath the cam, replace it with a new screw, or grind flush. Failure to do so will result in immediate impeller damage.
- G. At this time, if applicable, press on any gears (25), pulleys, or hubs onto the shaft. While pressing on the drive mechanism, the shaft (19) must be securely supported from the impeller end and in line with the press. Failure to do so will result in either damaged bearings and/or a canted gear with excessive run out. For the base model pumps P1716, P1722, P1727, P1730 and P1731, replace the tapered gear and gear nut on the shaft. Use Loctite #262 on the gear threads and torque the nut to 50 ft-lbs. For all other tapered gear and shaft assemblies, see the applicable engine manufacturers' requirements for thread sealant and torque specifications.
- H. Install the impeller (7) using a non-petroleum based lubricant such as silicon or soapy water. **Note:** Do not use petroleum-based fluids as they will damage the impeller. The impeller is installed using a twisting motion. Ensure the impeller blades are bent in the same direction as upon removal. Once installed, rotate the shaft to align keyway and slide the key (6) in place. Then cover the key hole in the impeller insert with the rubber end plug (5). **Caution:** Failure to place the plug in place on the 17000A impeller will cause the key to walk out of the shaft keyway and damage the cover. The 17000 impeller requires that the key be placed on the shaft prior to installation.
- I. Replace the cover o-ring (4), cover (3), with the cover cap screws (1). Torque the cap screws to 14 ft-lbs. **Note:** If the cover is replaced with a new one, record the information on the original cover to help identify the pump for future repairs and maintenance.
- J. After installation, inspect the pump seal, lip seal, body, housing and cam areas for leaks.

17000 Impeller Options

17000A —Impeller with **threaded/thru-key insert** allows for ease of installation in hard-to-reach applications as well as easy removal. As the impeller puller is threaded in the impeller insert and jacks against the pump shaft, the patented threaded insert allows for easy removal. The thru-key aspect of the impeller allows for the impeller to be installed prior to placing the key in the shaft keyway, therefore, making the installation process easier. (Patent No. 6,116,855)

17000K —Impeller Kit

- Kit Contains: 17000A Impeller with **threaded/thru-key insert**, o-ring and rubber cap.

17000 —Impeller only, which uses a **threaded insert** for ease of removal (Patent No. 6,116,855).

27000K — Impeller Kit (Patent No. 6,116,855)

- Kit Contains: 27000 splined impeller and o-ring.



Threaded Impellers
(17000 and 27000)



**Threaded Thru-Key
Design Impellers**
(17000A)

Assembly / Disassembly Instructions (continued)

Sherwood #		P176X	P1710X	P1710A	P1716X	P1719X	P1722X	P1726X	P1727X
		P176	P1710		P1716B-01	P1719	P1722B-01	P1726	P1727FB
		P176-02*	P1710-02*		P1716B-02*	P1719-01	P1722B-02*		P1727FB-01
						P1719F-01			P1727FB-02*
Item	QTY								
1	Cap Screw	3	16029	19626	19626	19626	19626	19626	19626
2	Lockwasher	3	15944	15944	15944	15944	15944	15944	21573
3	Cover Plate	1	18742	18742	18742	18742	18742	18742	18742
4	O-ring	1	15945	15945	15945	15945	15945	15945	15945
5	Impeller Cap	1	19210	19210	19210	19210	19210	19210	19210
6	Key	1	19667	19667	19667	19667	19667	19667	19667
7	Impeller	1	17000	17000	17000	17000	17000	17000	17000
8	Cam	1	18271	18271	18271	18271	18271	18271	18271
9	Cam Screw	1	10515	19714	19714	19714	19714	19714	19714
10	Retaining Ring (Ext)	2/3	15952	15952	15952	15952	15952	15952	15952
11	Washer	1	15959	15959	15959	15959	15959	15959	15959
12	Washer	2	19614	19614	19614	19614	19614	19614	19614
13	Wear Plate-Pin Assy	1	18441	18441	24162	18441	18441	18441	18441
14/15	Water Seal/Seat Assy	1	15955	15955	23799	15955	15955	15955	15955
16	Spacer	1	15940	19707	24150	19615	19615	19707	19615
17	Retaining Ring (Int)	1	15942	15942	15942			15942	
18	Housing	1	19015	19683	24161	19630	24409	19630	24161
19	Shaft	1	19620				19345		
19	Shaft/Bearing Assy	1		24469	24469	24470		24470	24469
20	Ball Bearing	2	15951				15951		
21	Adaptor Bolts	4		19708	19708	19708	19708	19708	19708
23	Oil Lip Seal	1		21776	21776	19674	19674	19674	21776
24	Adaptor	1		19699	19699	19727	19700	19955	19699
25	Gear Assy/Hub	1				19885		19885	19885
	Cam Screw O-ring	1		19712	19712	19712	19712	19712	19712
	Gear Nut	1				19730		19730	19730
	Adaptor Gasket	1				21570		21570	21570
	Flanged Port O-rings	2							21525
	Flanged Port Bolts	8							
	Minor Repair Kit		23973	23973	24576	23972	23972	23972	23973
	Major Repair Kit		23975	23975	24577	23974	23974	23974	23975

* Denotes pump used 23799 mechanical seal

Sherwood #		P1727A	P1730X	P1730A	P1731	P1732X	P1732A	P1733X	P2701X	
			P1730-01		P1731-01	P1732-01		P1733F-01	P2701-01	
			P1730-02*		P1731F-02*	P1732-02				
			P1730F-01							
Item	QTY									
1	Cap Screw	3	19626	19626	19626	19626	19626	19626	19626	
2	Lockwasher	3	21573	21573	21573	21573	15944	15944	21573	
3	Cover Plate	1	18742	18742	18742	18742	18742	18742	18742	
4	O-ring	1	15945	15945	15945	15945	15945	15945	15945	
5	Impeller Cap	1	19210	19210	19210	19210	19210	19210	19210	
6	Key	1	19667	19667	19667	19667	19667	19667	19667	
7	Impeller	1	17000	17000	17000	17000	17000	17000	27000	
8	Cam	1	18271	18271	18271	18271	21318	21318	18271	
9	Cam Screw	1	19714	19714	19714	19714	19714	19714	19714	
10	Retaining Ring (Ext)	2/3	15952	15952	15952	15952	15952	15952	15952	
11	Washer	1	15959	15959	15959	15959	15959	15959	15959	
12	Washer	2	19614	19614	19614	19614	19614	19614	19614	
13	Wear Plate-Pin Assy	1	24162	18441	24162	18441	18441	24162	18441	
14/15	Water Seal/Seat Assy	1	23799	15955	23799	15955	23799	23799	15955	
16	Spacer	1	24222	19615	24222	19615	19707	24150	24014	
17	Retaining Ring (Int)	1					15942	15942		
18	Housing	1	24176	24176	24176	24176	24161	24161	24409	
19	Shaft	1						24015		
19	Shaft/Bearing Assy	1	24470	24470	24470	24470	24469	24469	24306	
20	Ball Bearing	2						15951		
21	Adaptor Bolts	4	19708	19708	19708	19708	19708	19708	19708	
23	Oil Lip Seal	1	24250	19674	24250	19674	21776	21776	24017	
24	Adaptor	1	21205	21985	21985	21985	19699	19699	24016	
	Gear Assy/Hub	1	19885	22495	22495				24144	
	Cam Screw O-ring	1	19712	19712	19712	19712	19712	19712	19712	
	Gear Nut	1	19730	19730	19730	19730	19730	19730		
	Adaptor Gasket	1	21570	21570	21570					
	Flanged Port O-rings	2	21525	21525	21525	21525	21525	21525	21525	
	Flanged Port Bolts	8		21484	21484	21484	21484	21484	21484	
	Minor Repair Kit		24578	23972	24578	23972	23973	24576	23972	
	Major Repair Kit		24579	23974	24579	23974	23975	24577	23974	

* Denotes pump used 23799 mechanical seal

Preventative Maintenance

The #1 reason for premature engine wear is overheating. To maintain engine performance, insist upon genuine Sherwood impellers and service kits.

Maintenance Schedule	Pleasure Boating (Low Hours)		Commercial/Fishing Use (High Hours)	
	Light Duty	Severe Duty (High RPM, Silt or Sand)	Heavy Duty	Severe Duty (High RPM, Silt or Sand)
Impeller Kit	Every year	6 months	6 months	3 months
Minor Kit	2 years	Every year	Every year	6 months
Major Kit	4 years	2 years	2 years	Every year

	Impeller Kit 17000K	Impeller Kit 27000K	Minor Kit 23972	Minor Kit 23973	Minor Kit 24576	Minor Kit 24578	Minor Kit 24580	Major Kit 23974	Major Kit 23975	Major Kit 24577	Major Kit 24579	Major Kit 24581
P176X	X			X					X			
P1710X	X			X					X			
P1710A	X				X					X		
P1716X	X		X					X				
P1719X	X		X					X				
P1722X	X		X					X				
P1726X	X			X					X			
P1727X	X		X					X				
P1727A	X					X					X	
P1730X	X		X					X				
P1730A	X					X					X	
P1731	X		X					X				
P1732X	X			X					X			
P1732A	X				X					X		
P1733X	X		X									
P2701X		X					X					X

Inspection

The #1 reason for premature engine wear is overheating.

To maintain engine performance, insist upon genuine Sherwood impellers and service kits.

Recommended inspection to be performed at any service interval:

Impeller	Inspect for cracks or tears. Also, inspect for excessive abrasion of vane ends. Replace annually or if any of the conditions exist, as in the picture below.*
Wear Plate	Inspect for wear, flatness, and pin for fatigue. Replace at minor and major pump rebuild or if wear is evident to maintain pump flow and suction performance.
Cam	Replace at major pump rebuild or if pitting/wear is evident.
Cover	Replace at major pump rebuild or if wear exists to maintain pump flow and suction performance.
Mechanical Seal	Replace at minor and major pump rebuild or if leaking.
Lip Seal	Replace at minor and major pump rebuild or if leaking.
Shaft	Inspect for wear in area of lip seal and rubber impeller. Grooving of lip seal area or heavy fretting of the impeller end shaft will require shaft replacement.
Bearing	Inspect for loss of grease, corrosion or rough rotation. Replace at major pump rebuild or if in doubt.

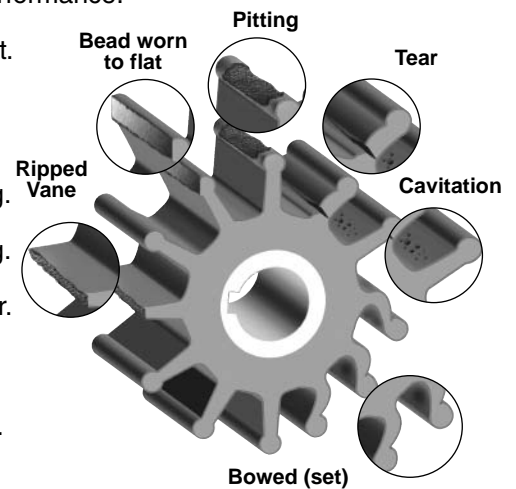

Genuine Sherwood Tech Tips

Sherwood recommends replacing your impeller annually. Proper storage of the impellers during a prolonged lay-up can help maintain the life of the impeller.

Remove the impeller from the housing and store it in a cool, dark place. This will avoid the following:

- Copper bonding of the impeller to the housing
- Vanes “setting” into position as stored in the housing
- Ultraviolet deterioration

Three tips to help you install your new Sherwood impeller:

- Use a non-petroleum based lubricant (silicon or soapy water) to help slide the impeller into the housing.
- Install the impeller with a twisting motion onto the shaft. Never force an impeller onto the shaft.
- Impeller must be able to move freely on the shaft to properly prime and function.

(Use a small amount of non-petroleum based lubricant to help hold the o-ring when replacing the cover.)

* See Maintenance Schedule