

VR050 12/24V Fuel Transfer Pump

Features

- Faster refuelling - 50 litres/minute (13 GPM)
- High head capability - 10 metres (32 feet)
- Self priming up to 3 metres (9.6 feet)
- Continuously rated*
- Vibration tested
- IP55 protected motor
- 24V version with thermal cut-out protection
- Full range of installation accessories
- Customised kits for OEM customers

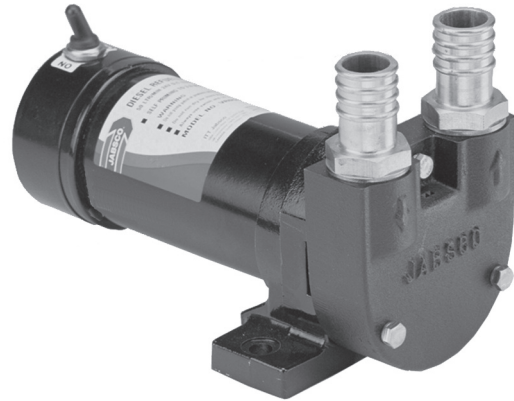

Typical Applications

- Designed for refuelling medium sizes diesel powered vehicles [typical tank sizes 200 - 500 litres (50 - 200 gallons)] from drums.
- Suitable for mounting to the following equipment: Excavators, Cranes, Road rollers (compactors), Pavers, Agricultural machines, Generators, Helicopters.
- Suitable for diesel fuel, Kerosene, Paraffin, Hydraulic oils, Oils up to 150 centi Stokes (750 Saybolt Universal) viscosity.

Specifications

Temperature Range : -30°C to +50°C (-22°F to +104°F)

Pump Body : Cast Iron

Rotor : Sintered Iron

Vanes : Sintered Bronze

Shaft : Carbon Steel

Seal : Nitrile Lip Seal. (Viton - 2120v - 2022v)

Ports : Vertical ¾" BSP or 25mm hose adaptors (1").

Motor : 12V or 24V DC permanent magnet, corrosion resistant IP55 protected

Duty : *Continuously rated up to 3 metres (10 ft.), total head of diesel fuel at 40°C (104°)

Model Range

Model number	Description
VR050-2022V	¾" BSP ports, 12v DC, switch & fuse for B20 BIO DIESEL
VR050-2022	¾" BSP ports, 12v DC, switch & fuse
VR050-2120V	¾" BSP ports, 24v DC, for B20 BIO DIESEL
VR050-2120	¾" BSP ports, 24v DC
VR050-2122	¾" BSP ports, 24v DC, switch & fuse
VR050-1120	25mm (1"), Hose ports, 24v DC
VR050-1022	25mm (1"), Hose ports, 12v DC, switch & fuse
VR050-1122	25mm (1"), Hose ports, 24v DC, switch & fuse
VR050-1123	25mm (1"), Hose ports, 24v DC, automatic shut off controller
VR050-B013	25mm (1"), Hose ports, 24v DC, switch & fuse, fitted with by-pass
Accessories For further information see Data Sheet 43010-0031	
23738-0010B	Check valve kit
23739-0000B	Foot valve kit
23739-0100B	Foot valve with shrouded strainer
23541-0001G	Hose - 25mm (1") bore, [per metre]
23733-0000	Suction strainer 250 micron
50290-1000	Shrouded strainer



Explosion hazard. Do not pump gasoline, solvents, thinners or other flammable liquids. To do so can cause an explosion resulting in injury or death.

VR050 Diesel Refuelling Pump

Jabsco Pumps VR050-1122

Dimensions in mm (inches)

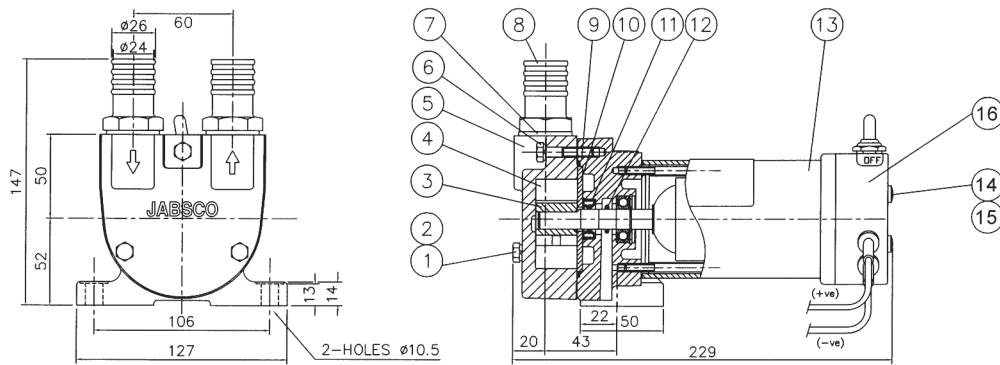

Parts List

Key	Description	Qty	Part No.	Version -2120V	
1	Bolt	M6 x 42	2	X3000-191F	
2	Spring washer		3	X3081-091F	
3	Rotor		1	50242-0000	
4	Vane*		4	Use SK421-0000	
5	Body	BSP	1	50244-2000	
		NPT	1	50244-9000	
6	Bolt	M6 x 30	1	X3000-186F	
7	Sealing Washer		2	SP1613-1415	
8	Port adaptor		2	23543-1000	
9	O-Ring*		1	X4020-264A	X4020- 264B
10	Backplate		1	50246-0000	
11	Seal*		1	SP2701-0504	SP2701- 1071
12	O-Ring*		1	X4020-211A	X4020- 211B
13	Motor	With Switch 12V	1	98012-9295B	
		& Fuse 24V	1	98012-9296B	
		Basic 24V	1	98012-9297B	
14	Screw (Pack 10)		2	91046-6001B	
15	Sealing washer (Pack 10)		2	91608-6001B	
16	Fuse (Pack 10)	20 Amp (12V)	1	92005-6020B	
		10 Amp (24V)	1	92005-6010B	

Service kit contains items marked *SK421-0000

Note

All performance information is based on diesel fuel at 20°C (68°F). On production product, this may vary by up to 10%. Maximum recommended total head of diesel fuel is 10 metres.

Performance

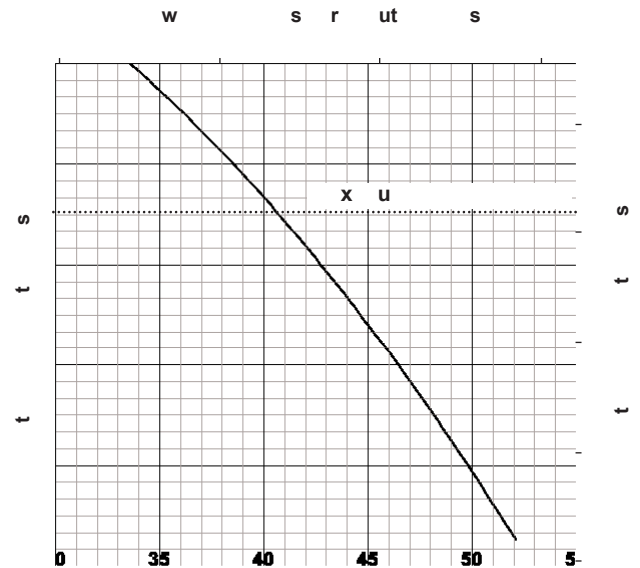

Current Draw 12V = 12 Amps @ 3m head

24V = 6 Amps @ 3m head

Maximum Current 12V = 20 Amps

24V = 10 Amps

Safety

Do not use for pumping petrol, gasoline or products with a flash point below 37°C (99°F). Do not dry run. Always fit a fuse.

xylem
Let's Solve Water

Jabsco, 1 Kondelin Road, Cape Ann Industrial Park, Gloucester, MA 01930
Tel: +1 978 281 0440 Fax: +1 978 283 2619

USA

Jabsco, Bingley Road, Hoddesdon, Hertfordshire, EN11 0BU
Tel: +44 (0) 1992 450 145 Fax: +44 (0) 1992 467 132

UK

NHK Jabsco Co Ltd, 3-21-10, Shin - Yokohama Kohoku-ku, Yokohama 222
Tel: +81 (0) 45 475 8906 Fax: +81 (0) 45 475 8908

JAPAN

Jabsco GmbH, Ostraße 28, 22844 Norderstedt
Tel: +49 (0) 40 53 53 73 0 Fax: +49 (0) 49 53 53 73 11

GERMANY

Jabsco Italia, s.r.l., Via Tommaseo, 6, 20059 Vimercate, Milano
Tel: +39 039 685 2323 Fax: +39 039 666 307

ITALY