



BARE SHAFT PEDESTAL FLEXIBLE IMPELLER PUMP

FEATURES

- Carbon /Ceramic mechanical seal
- Sealed for life spaced bearings
- 1" NPT or 1" BSP ports
- Multi position mounting foot
- Standard pressure Jabsco neoprene impeller
- Automotive electromagnetic clutch

MODEL RANGE

Pump Model	Port Size
52580-2001	1" BSP
52580-9001	1" NPT

APPLICATION

Marine; engine cooling, bilge pumping, washdown and deck flooding, ballast transfer, general purpose pump, fire fighting.

Industrial; circulation and transfer of water, sump drainage, cellar drainage, emergency pumping.

Farming/Agriculture; waste water removal, shallow well pump, ditch drainage.

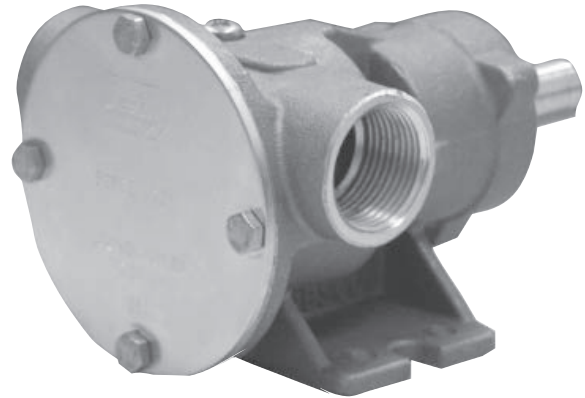

Models 52580-Series

	<p>WARNING: Do not use any Jabsco pump for petrol, petroleum products or any products with a flash point below 37°C (98°F), explosion or death may occur.</p>
--	--

	<p>Injury hazard. Exposed pulleys and belts can cause injury. Install shield around pulleys and belts. Stay clear while machinery is operating.</p>
--	---

	<p>Do NOT run dry.</p>
--	------------------------

Jabsco Pumps 52580-9001

INSTALLATION www.PumpAgents.com - Click here for Pricing or **DIS-ASSEMBLY PUMP** Pumps and Parts

Pumps must be securely mounted on a rigid surface. Pumps can be mounted in any position. If mounted vertically, ensure the bearings are above the pump head to ensure long life.

The rotation of the pump shaft determines the location of the inlet and outlet port. All pipework must be supported to avoid stress on the pump. Suitable fittings must be used to connect the piping to the pump and sealed accordingly. Inlet pipework must be either rigid or reinforced to avoid collapsing under vacuum.

Excessive belt tension will result in premature bearing failure. The belt should be set to allow 16mm (1/2") of movement over 1m (3ft) of span when pushed.

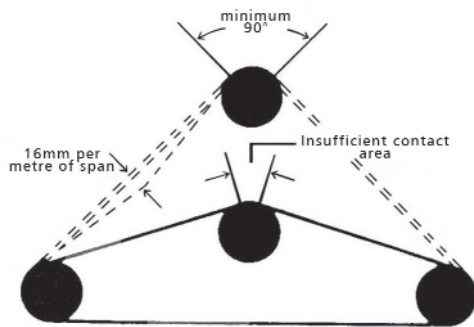

Ideal belt contact area should not be less than 90° of the pulley circumference.

Ensure that all moving parts are adequately guarded to prevent accidents.

OPERATION

Pumps are dry self priming. If fluid does not enter pump after 30 seconds, stop pump, and check inlet hose for leaks and/or blockages.

Maximum speed for these pumps is 2200 rpm, do not operate pump outside the published limits without consulting the factory appointed distributor.

Do NOT allow liquid to freeze in the pump, drain pump by loosening end cover screws.

SERVICE INSTRUCTIONS

Inspect all parts for wear or damage and replace as necessary.

1. Remove end cover screws, end cover, and o-ring.
2. Remove spline seal and impeller using impeller removal tool.
3. Remove cam screw, cam, and wearplate.
4. Remove seal retaining ring.
5. Remove bearing dust seal (if fitted) and bearing retaining ring (if fitted)
6. Carefully push shaft from pump end to remove shaft/bearings assembly.
7. Remove seal from body.
8. Remove slinger o-ring and press off bearings.

RE-ASSEMBLY PUMP

1. Press bearing onto shaft and fit into body.
2. Replace bearing retaining ring (if fitted) and dust seal (if fitted).
3. Fit o-ring slinger.
4. Carefully install seal in pump body ensuring seal faces are clean and fit seal retaining ring.
5. Fit wearplate, cam, and cam screw ensuring cam screw o-ring seal is in place.
6. Fit impeller using a small amount of suitable grease.
7. Fit spline seal, o-ring, end cover, and end cover screws.

Jabsco Pumps 52580-9001

PERFORMANCE CURVE (UK & US Versions) [Click here for Pricing/Ordering for Pumps and Parts](#)

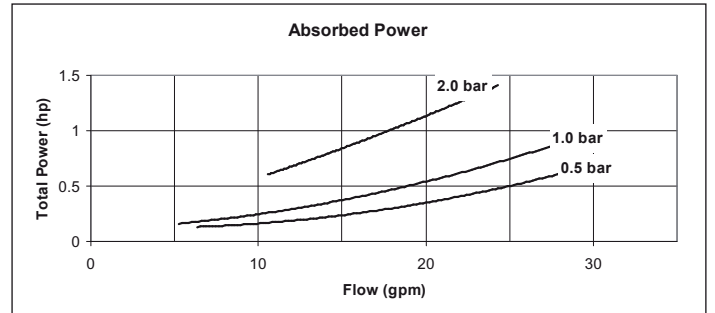
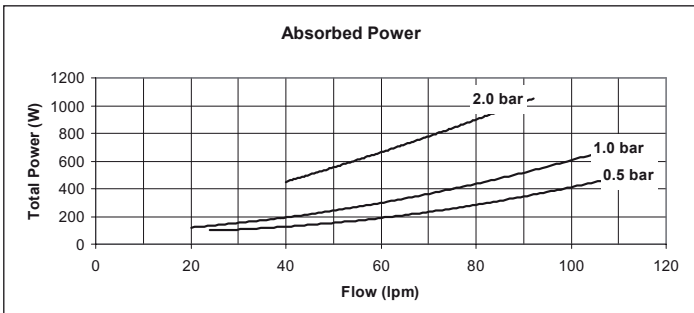
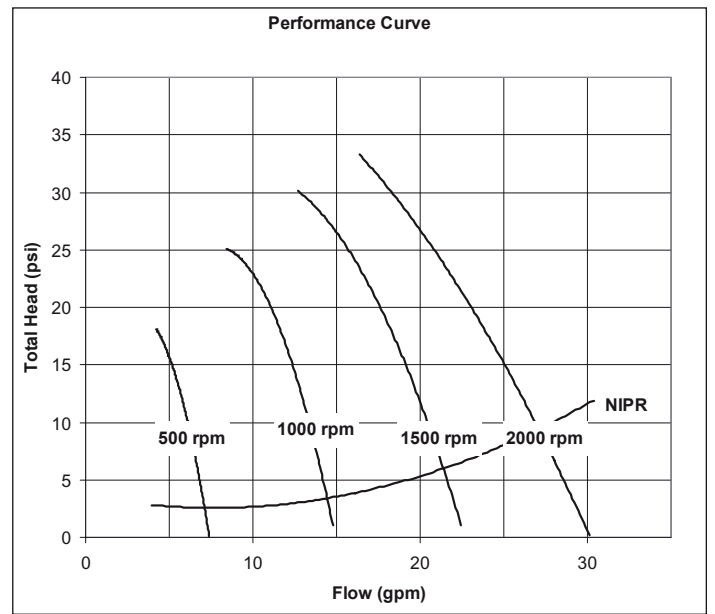
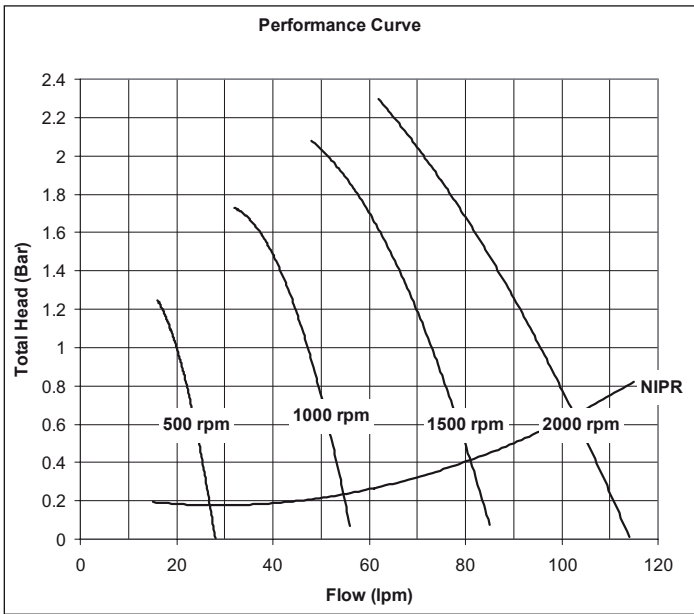

PARTS LIST

KEY	DESCRIPTION	PART NUMBER	QTY
1	BEARING SHIELD	51586-0000	1
2	BEARING, BALL	SP2601-0468	2
3	BODY 080	51584-2000	1
4	CAM	53082-0000	1
5	ENDCOVER	50355-0000	1
6	HEX HEAD SCREW	X3001-176F	4
7	IMPELLER 080	920-0101	1
8	KEY 5x5x28	X4000-209A	1
9	MECH SEAL	96080-0620	1
10	O-RING	X4020-106A	1
11	O-RING	X4020-215A	1
12	O-RING	X4020-269A	1
13	RETAINING RING	SP1700-62	1
14	RETAINING RING	SP1701-438	1
15	ROLL PIN	SP3100-10	1
16	SCREW	X3003-176F	1
17	SHAFT 080	52587-0000	1
18	SPLINE SEAL	4345	1
19	SUPPORT WASHER	29706-0000	1
20	WEARPLATE	4156	1

Jabsco Pumps 52580-9001

www.PumpAgents.com - Click here for Pricing/Ordering for Pumps and Parts

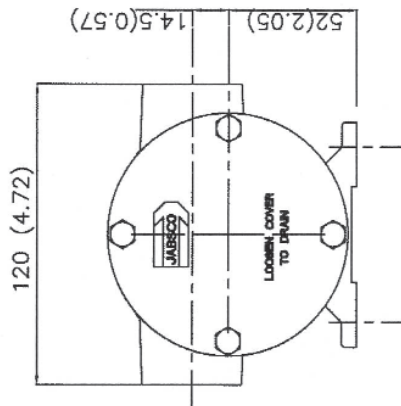
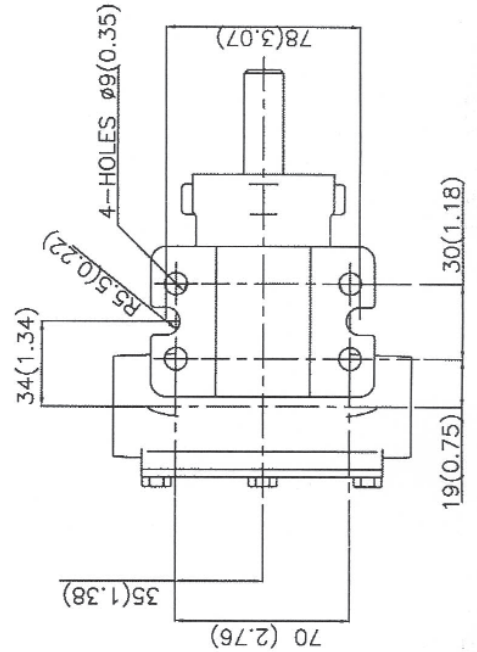
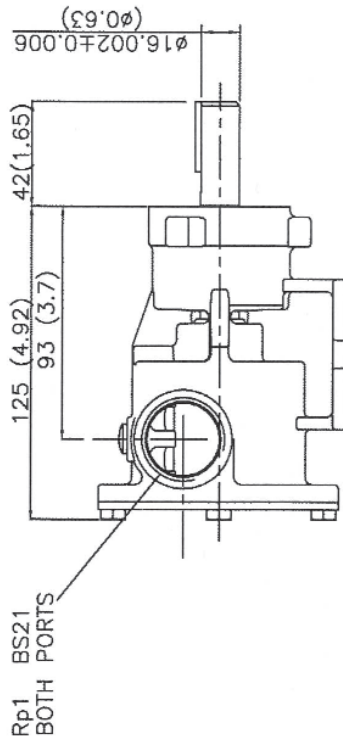
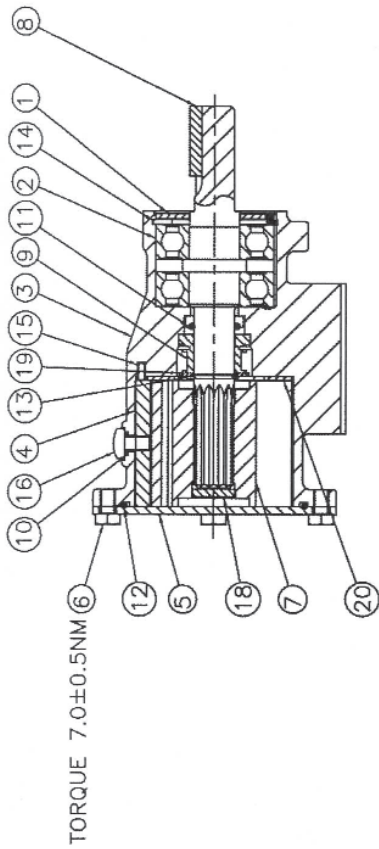

xylem
Let's Solve Water

Jabsco, 1 Kondelin Road, Cape Ann Industrial Park, Gloucester, MA 01930

Tel : +1 978 281 0440

Fax : +1 978 283 2619

USA

Jabsco, Bingley Road, Hoddesdon, Hertfordshire, EN11 0BU

Tel : +44 (0) 1992 450 145

Fax : +44 (0) 1992 467 132

UK

Fluid Products Canada, 55 Royal Road, Guelph, Ontario N1H 1T1

Tel : +1 519 821 1900

Fax : +1 519 821 5316

CANADA

NHK Jabsco Co Ltd, 3-21-10, Shin - Yokohama, Kohoku-ku, Yokohama 222

Tel : +81 (0) 45 475 8906

Fax : +81 (0) 45 475 8908

JAPAN

Jabsco GmbH, Oststraße 28, 22844 Norderstedt

Tel : +49 (0) 40 53 53 73 0

Fax : +49 (0) 40 53 53 73 11

GERMANY

Jabsco Italia, S.r.l., Via Tommaseo, 6, 20059 Vimercate, Milano

Tel : +39 039 685 2323

Fax : +39 039 666 307

ITALY

Warranty: All products of the company are sold and all services of the company are offered subject to the company's warranty and terms and conditions of sale, copies of which will be furnished upon request. The information provided herein is for guidance only, it does not constitute a guarantee of the performance or specification of any individual product or component.
© 2012 Xylem, Inc. All rights reserved. JABSCO is a registered trademark of Xylem Inc. or one of its subsidiaries.