



Model 36970-2 SERIES

ELECTRIC WATER SYSTEM PUMPS

Automatic Multi-Fixture

FEATURES

- Self-Priming
- Diaphragm Design Allows Dry Running
- Built-in Discharge Check Valve
- Low Current Draw
- Built-in Hydraulic Pulsation Dampener
- Large Vibration Absorbing Pads
- Barb Ports; Threaded or Flared Port Combinations also Available
- Meets USCG **Electrical** Standards

Model 36970-2 SERIES

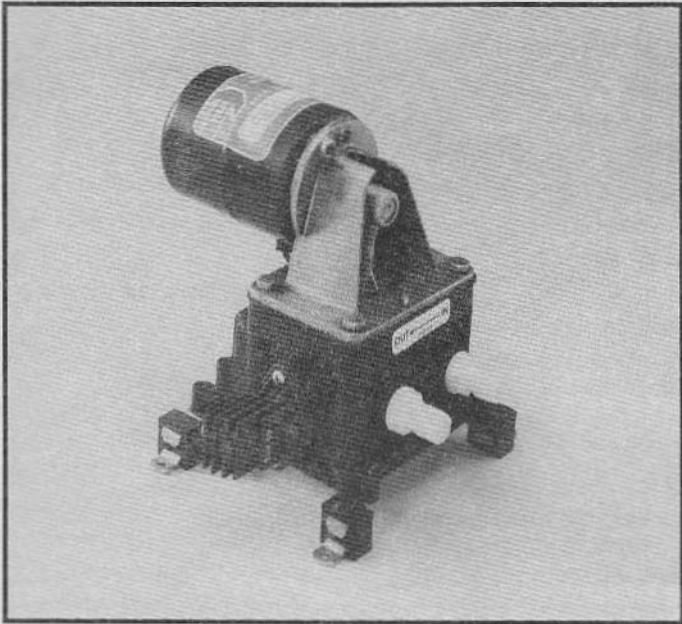

SPECIFICATIONS

	u.s. GPM	Utres/min	Imp. GPM
Open Flow;	2.8	10,6	2.3
Cut-in Pressure (Nominal);	20 psi (1.4 bar)		
Cut-off Pressure (Nominal);	40 psi (2.8 bar)		
Ports;	Slip on 1/2" to 5/8" 10 hose, 1/2" Threads or 1/2- Flare		
Vert. Dry Suction Ufe;	5 Feet (1,52m)		
Weight;	nbs. (3,2kgs)		

APPLICATIONS

PAR Automatic Water Systems, 36970-SERIES, are designed for self contained recreational vehicles and pleasure boats with **multiple** fixture water systems. The systems are automatic when a faucet is opened, the pump instantly begins operation to provide a constant flow from tank to faucet. Closing the faucet automatically discontinues pump operation.

MODEL	VOLTAGE	NOM. AMP DRAW	FUSE RATING	
			SLOW-BLOW	NORMAL
36970-2000	12Vdc	5.0	5 amp	7-112 amp
36970-2010	24 Vdc	3.0	4 amp	5 amp
36970-2020	32 Vdc	2.0	2amp	3 amp

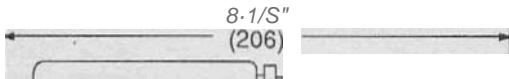

PUMP DIMENSIONS

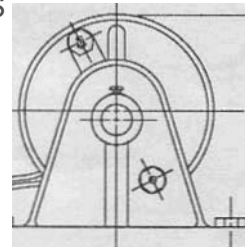

6-5/16"
(160)

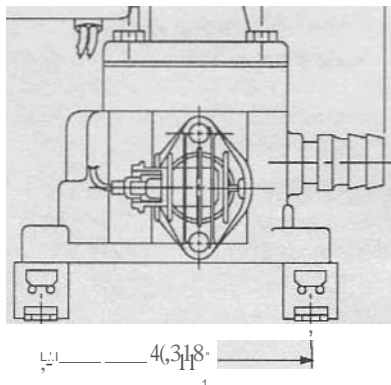

6-5/16"
(160)

Dimensions in parenthesis are millimetres

INSTALLATION

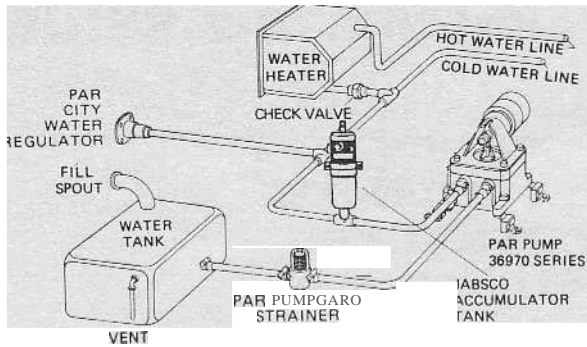

WIRING

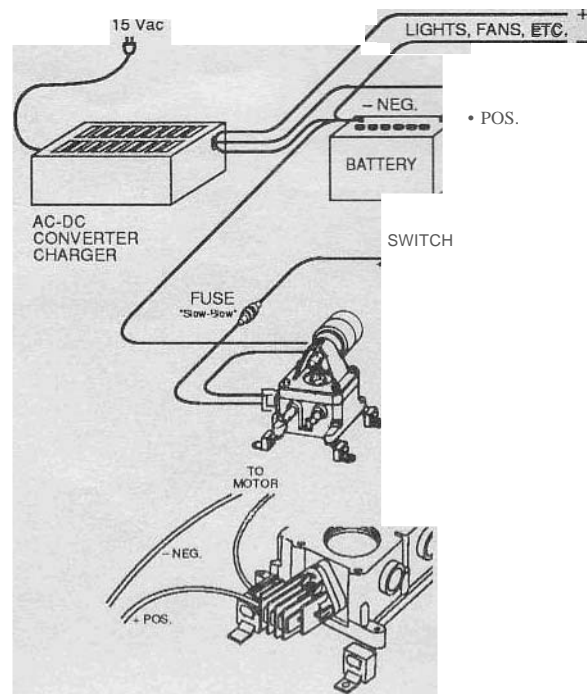

MOUNTING

PAR diaphragm pumps are self-priming. They may be located above or below (above preferred) the fresh water tank. Suction lift should not exceed 5 feet, when positioned above the tank. The pump is equipped **with** vibration pads which are most effective when the pump is in the upright position.

PLUMBING

To minimize water pressure drop, the size of water supply line should NOT be less than sizes shown in table below. Valves, elbows, etc. used should be the same size as pipe or tubing. Use gate valves only. Fresh water tank must **be** vented.

MINIMUM PIPING SIZE

Supply Line Length	Tubing 1.0.	Pipe Size
Less than 48"	1/2"	3/8"
48" or more	5/8"	1/2"

PRESSURE REGULATOR It is recommended that systems having a connection for a city water entry be equipped with a pressure regulating check **valve** set at approximately 35 p.s.i. This **valve** automatically regulates the incoming water pressure to avoid damage to pump and plumbing from excessive pressures. PAR Models 44410-1000 (Permanent Flush Mount) and 44410-1010 (in-line Hose Type) pressure regulating valves are recommended for this purpose.

CHECK VALVES A **built-in** port check **valve** protects the pump from the unregulated high pressure sometimes encountered in city water hookups. However, an additional check **valve** may be installed at the cold water inlet of the water heater to minimize heat transfer to the cold water line and protect the system in case of water heater relief **valve** failure. PAR offers qualified in-line check **valves**, Models 34344-0000, 35027-0000 and 35195-0000.

SUCTION STRAINER A PAR No. 36400-Series (strainer) is recommended, installed between the pump and fresh water tank. It helps prevent **valve** clogging caused by foreign material entering the pump.

WATER PURIFIER NOTE: Water purifiers should be installed with separate outlets for drinking water use only. Many purifiers cause excessive back pressure.

ACCUMULATOR TANK The use of an accumulator tank (Jabsco® Model 12573-2000 or 18810-0000), although not required, is recommended for a more effective water distribution system. It eliminates "water hammer," stores pressure to allow a limited use of water without restarting pump (desirable at night-time), assures a constant **even** stream of water at faucets farthest from pump and prolongs pump **life** by cutting down rapid start/stop operation.

WIRING

Pump should be wired **in** an independent circuit according to the following chart:

WIRE SIZE CHART (AWG - COPPER)

Voltage	Length of circuit in feet (sum of pos. & neg. wire lengths)		
	Upto 80'	80' to 100'	100' to 150'
12 Volts Two Wire	14	12	10
24 Volts Two Wire	16	14	14
32 Volts Two Wire	16	16	14

Above wire size recommendation is based on pump load only. If other electrical fixtures share common service with the pump, larger wire sizes must be used.

MOTOR PROTECTION The pump wiring must include a "Slow-Blow" fuse or equivalent protective device in the positive lead to protect against overcurrent draw. See specification table for proper fuse rating.

SWITCH An on-off switch should be installed in the circuit to turn off pump when vehicle or boat is unattended, stored, or in transit.

AC-DC POWER CONVERTERS Converter/charger packs, (ac-dc), should be wired to operate pump directly from the battery at all times. If the battery is bypassed and converter is used to service the pump directly, be sure the total electric loads do not **exceed** the converter amp rating.

VOLTAGE CHECK After installation, check the voltage at the pump motor. It is important that voltage is checked when pump is operating along with all the inside electrical fixtures. Full voltage must be available at the pump motor at all times.

OPERATION

- Check level of water in tank.
- Check **all** strainers or any aerators and clean thoroughly.
- Open all faucets, hot and cold.
- Turn on power to pump and **wait** for hot water tank and water lines to fill.
- Close each faucet when it starts to deliver a steady stream of water (close cold water faucet first).
- Observe the pump. Check to be sure pump stops soon after closing last faucet.
- Pump is now ready for automatic operation. It will start when a faucet is opened and stop when the faucet is closed.
- Relieve system pressure before hooking up to city water.
- If pump will be inoperative for a considerable length of time, turn off circuit to pump and bleed system by opening faucets.

MAINTENANCE

WINTER STORAGE. PAR pumps, with its unique pulsation dampener, will withstand frozen water **without** damage provided **the** system is not under pressure prior to freezing. To prevent accidental damage, the entire water system should be protected from freezing during winter storage. **This** requires complete draining, using the following directions and/or **vehicle** manufacturer's instructions:

1. Open all faucets and drains and allow pump to empty water tanks and intake line. Run **the** pump dry for 1 to 2 minutes before turning off.
2. With all drains open, blow air through city water entry. Allow time for water heater to empty.

3. Disconnect discharge and intake hoses from the pump. Start the pump and allow to run until all water is expelled from unit. (Running dry will not harm the pump).
4. Reconnect the hoses, close the drains and leave faucets open. The water distribution system is now dry and ready for winter storage.

An alternate method is to use potable water system anti-freeze solution. Follow directions of anti-freeze manufacturer.

DANGER: DO NOT USE AUTOMOTIVE TYPE RADIATOR ANTI-FREEZE. IT IS POISONOUS. USE OF THIS TYPE OF ANTI-FREEZE WILL CAUSE SERIOUS INTERNAL INJURY OR DEATH.

SERVICE

NOTICE: Before servicing pump, turn all power to pump and open faucets to relieve pressure in water system.

VALVES ASSEMBLY REPLACEMENT

1. Remove four tie down screws.
2. Lift off motor and diaphragm assembly from pump base.
3. Lift valve assemblies from pockets and clean all foreign materials from valves and seats.
4. Reinstall valve assemblies into same pockets, being sure rubber valve **with** small hole is UP on intake and **rubber** valve without the small hole is DOWN on discharge.
NOTE: Do not use valve with small hole in **rubber** on discharge side of pump.
5. When reassembling, adjust **belt** tension to 1/4" play.

DIAPHRAGM & CONNECTING ROD REPLACEMENT

1. Turn off power to pump. Remove four motor mount tie down bolts.
2. Lift motor mount and the attached diaphragm assembly from pump base.
3. Remove two diaphragm retainer screws and the diaphragm retainer.
4. Pull connecting rod assembly and diaphragm from motor mount, then, unscrew bolt to separate diaphragm plates.
5. Loosely reassemble new diaphragm, diaphragm plates, washer and diaphragm bolt onto new connecting rod assembly.
6. Slide connecting rod on shaft. Ensure that eccentric is firmly seated on motor shaft and tighten set screw firmly against flat side of shaft.
7. Tighten connecting rod bolt while maintaining alignment of rod bearing eccentric. **NOTICE: Avoid** misalignment or twisting of rod on eccentric shaft or excessive bearing wear will result.

TROUBLESHOOTING

Problem

Causes

Pump operates but no water flows through faucet.	- Low water level in tank. - Loose hose clamps or fittings in suction line . - Dirty or hard-to-open in-line check valve. - Defective pump check valve. - Suction line clogged or kinked.
Pump cycles on and off although all faucets are closed.	- Water leak in plumbing. - Water leak in flush toilets. - Outlet valve not sealing. - Internal leak in pump.
Pump operates roughly and has excessive noise and vibration.	- Deformed or ruptured pulsation dampener in pump. - Worn connecting rod bearing. - Pump mounted on flimsy board. - Flow through intake line is restricted, kink in hose.
Pump fails to start when faucet is opened.	- No voltage to pump. - Blown fuse. - Defective pressure switch. - Clogged piping. - Kink in outlet line.
Pump fails to stop when faucets are closed.	- Empty water tank. - Outlet valve not sealing. - Air in system. - Defective pressure switch. - Very low voltage.

EXPLODED VIEW

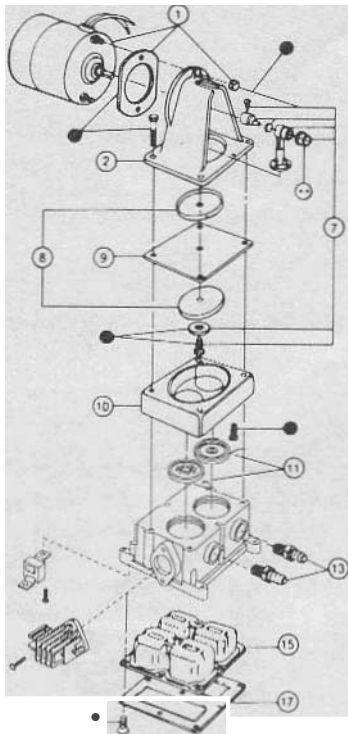

● Indicates items included in Hardware Kit (Key 21).

PART LIST

36970-S&Ples

KTY	Part O'Kripilon	Part Number	Qty
1	Motor Kit 12 Vdc	30201-0000	1
1	Motor Kit 24 Vdc	30201-0010	1
1	Motor Kit 32 Vdc	30202-0020	1
2	Motor Mount	35452-0000	1
7	Connecting Rod Assembly	30033-0000	1
8	Diaphragm Plate	35479-0000	2
9	Diaphragm	30015-0000	1
10	Retainer	35454-0000	1
11	Valve Set (Inlet & Outlet)	30004-0000†	1 Set
12	Base Assembly†	44114-1100	1
13	Pressure Switch	37121-0000 - See Note 2	1
15	Ports (Inlet & Outlet) Barb	37176-0000† - See Note 4	1 Set
17	Pulsation Dampener	44127-1000	1
19	Bottom Plate	35686-0000†	1
20	Vibration Pad Kit	44990-0058†	1 Set
21	Hardware Kit	44990-0060	1 Set
	Service Kit	43990-0064	1

● Indicates Parts Contained In Service Kit.
† Indicates Parts Supplied with Bas. Assembly.

NOTE 2 - Includes Switch and Conversion Kit to Mount New Style Switch On Old Style-J and -0000 Pumps. Meets USCG Electrical Standards.

NOTE 3 - Replacement Switch only for -1000 series Pump. Meets USCG Electrical Standards.

NOTE 4 - Threaded Outlet Port 37050-0001
Threaded Inlet Port 37050-0000

THE PRODUCTS DESCRIBED HEREIN ARE SUBJECT TO THE JABSCO® ONE YEAR LIMITED WARRANTY, WHICH IS AVAILABLE FOR YOUR INSPECTION UPON REQUEST.

SERVICE (CONTINUED)

PULSATION DAMPENER REPLACEMENT

1. Remove **pump** from installation.
2. Remove **nine** screws from bonom of base and the bonom plate.
3. Pull out rubber pulsation dampener from base.
4. Inspect **dampener** for excessive deformation, ruptures and leaks.
5. When installing new pulsation dampener, make sure flange **is correctly seated to effect** a proper water and air seal.

PRESSURE SWITCH REPLACEMENT

1. When replacing the **pressure** switch, it is **important to check** the pulsation **dampener**. Please see Pulsation **Dampener Replacement instructions** above.

SWITCH REPLACEMENT - PROCEDURE A

Direct replacement of switch with threaded stem directly into pump body.

1. Disconnect power leads from **switch** and remove **switch** from **pump**.
2. Moisten **rubber side** of washer with water. Thread washer onto switch threads **with metallic** side of washer facing switch. Apply a thin film of sealing compound to the replacement switch threads. Keep compound clear of passage-way hole.
3. Screw replacement switch into pump base/body until snug.
4. Reconnect switch power leads.

SWITCH REPLACEMENT - PROCEDURE B

For **pump** base-body with flange mount and two **screw** holes only.

1. Disconnect power leads from switch. Remove two screws on switch flange and save. CAUTION: These **screws** hold down a strong spring. Hold switch firmly. Personal injury could result if switch body is allowed to fly loose. Remove switch housing, spring, plunger, and diaphragm from base/body.
2. Remove stem, retainer, and screws from switch and discard leaving switch housing, spring, plunger, and diaphragm.
3. Insert plunger and spring assembly into **base/body** noting stack-up in daphragm.
4. Cover with switch housing assembly. **Hold** firmly and retain with two **screws** saved from old switch.
5. Reconnect switch power leads.

BASE REPLACEMENT

1. Follow service instructions above to remove pressure switch and **pulsation** dampener.
2. To separate base from motor **mount** and diaphragm assembly remove four **tie** down screws
3. When reassembling, do not overtighten saews.

MOTOR REPLACEMENT

1. Disconnect one motor wire from pressure switch terminal, the other from splice connector.
2. Loosen eccentric set-screw on motor shaft.
3. Remove **two** motor nuts and pull motor away from **motor** mount, while holding back eccentric/connecting rod assembly.
4. When installing new motor, adjust **eccentric** on motor shaft so little or no contact is made between teflon washer and connecting rod bearing.
5. Rewire motor leads to **terminal** on **pressure** switch, and splice **connector**.



1485 Dale Way, P.O. Box 2158, Costa Mesa, CA 92628-2158, Telephone: (714) 545-8251
Bingley Road, Hoddesdon, Hertfordshire EN11 OBU England. Telephone: +44-992-467191

For technical advice or service please take your pump into your local pump service center.
To order pump or parts or for pricing please go to the following links :

[Jabsco Pumps Home >>](#)

[Jabsco Pumps stock list >>](#)