

SELF-PRIMING PUMPS

FEATURES

- Pump Type:** 30570-2XXX Pump Head
 30570-3XXX Pump Head
 30570-4XXX Close Coupled
 30570-5XXX Close Coupled
- Body:** 316 Stainless Steel
- Impeller:** Neoprene or EPDM
- Shaft Seal:** Mechanical; Carbon-on-Ceramic or Tungsten Carbide; Nitrile
- Ports:** 1-1/2" ACME Threads with Bevel Seat or Clamp Type
- Shaft:** 316 Stainless Steel
- Motor:** 230/460 Vac, 3 Phase, 60Hz, 5 HP
 1750 RPM, TEFC, C-Face, 184 TC Frame
- Weight:** 30570-2XXX 30.0 lb (18.6 kg) Approx.
 30570-3XXX 30.0 lb (18.6 kg) Approx.
 30570-4XXX 93.5 lb (42.5 kg) Approx.
 30570-5XXX 93.5 lb (42.5 kg) Approx.



Models 30570-2, 3, 4, 5XXX

VARIATIONS AVAILABLE

Model	Description
30570-2005	Standard Pressure, Neoprene Impeller,
30570-4005	Carbon Seal, ACME Ports
30570-2105	Standard Pressure, Neoprene Impeller,
30570-4105	Tungsten Carbide Seal, ACME Ports
30570-3005	Standard Pressure, Neoprene Impeller,
30570-5005	Carbon Seal, Clamp Ports
30570-3105	Standard Pressure, Neoprene Impeller,
30570-5105	Tungsten Carbide Seal, Clamp Ports

APPLICATIONS

DAIRY: Transfer and processing of raw milk, cream, milk whey, buttermilk, condensed milk.

FOODS: Processing of eggs, sugar liquors, brines, catsup, chocolate, glaze, gelatin, honey, jams, jellies, mayonnaise, molasses, mustard, pickle relish, vinegar, water, yeast slurries, syrups, liquids containing solids in suspension such as chopped tomatoes, nuts, peanut butter.

BEVERAGE: Circulating and transferring alcohols, beers, brewery slop, cider, distillery wort, extracts, flavors, juice, mash, soft drink syrups, wines.

PHARMACEUTICAL: Moving medicines, cosmetics, process chemicals, lotions, preparations, filtering solutions, used as a filling line supply pump.

N.B. 3A option to include Elastomers : EPDM and Neoprene. Ports : Tri-Clamp, IDF, 3A and DIN11851.

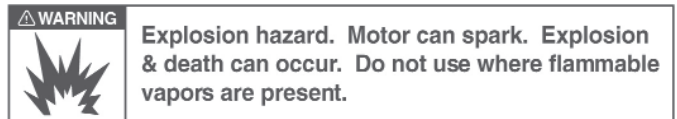

OPERATING INSTRUCTIONS

- INSTALLATION** – Pump may be mounted in any position. The rotation of the pump shaft determines the location of the pump's intake and discharge ports. (Refer to dimensional drawing.) Pump is normally assembled at factory for clockwise rotation looking at end cover. If counterclockwise rotation is desired, follow steps 1 and 2 of disassembly and step 9 of assembly instructions to change direction of impeller blade deflection under cam.
- MOTOR SELECTION** – Pump Head is designed to fit a 184 TC Frame NEMA C-Face Motor. Motor should be rated 5 horsepower at 1750 RPM with a service factor of one. Due to high bearing loads, motor should be ball bearing equipped with the front bearing locked against axial movement. Motor should be capacitor start and foot mounted.
- SPEEDS** – 100 RPM to the maximum shown in the performance curves. For longer pump life, operate at lowest possible speeds. Lower speeds are required for viscous liquids, consult the factory for proper speeds and horsepower requirements.
- SELF-PRIMING** – Primes at low or high speeds. For vertical dry suction lift of 10 feet, a minimum of 860 RPM is required. Pump will produce suction lift up to 22 feet when wet.

BE SURE SUCTION LINES ARE AIRTIGHT OR PUMP WILL NOT SELF-PRIME.

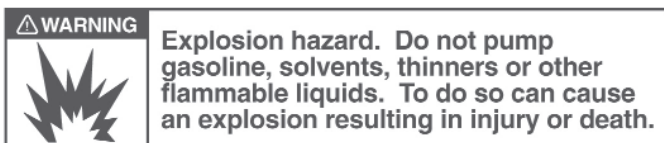

5. DISCHARGE - When transferring liquids further than 25 feet, use one size larger discharge pipe than discharge porting.
6. RUNNING DRY – Unit depends on liquid pumped for lubrication. DO NOT RUN DRY for more than 30 seconds. Lack of liquid will damage the impeller.
7. PUMPAGE COMPATIBILITY – Consult the Chemical Resistance Guide in the JABSCO Industrial Pump Catalog (available upon request from the factory) for proper body materials and impeller compounds. If corrosive fluids are handled, pump life will be prolonged if pump is flushed with a neutralizing solution after each use or after each work day. A Tungsten Carbide Seal variation is available for pumping liquids that contain abrasives or are highly corrosive.
8. PRESSURES – Consult Performance Curves for maximum recommended pressures for pump in continuous operation. If pressures exceed those shown, consult the factory.
9. TEMPERATURES – The operating temperature limits of the pump depend on the impeller compound. The following ranges apply:
 Neoprene - 45° to 150° F (7° to 65° C)
 EPDM - 45° to 185° F (7° to 85° C).
10. IMPELLER TORQUE – The torque required to initiate rotation of a new impeller in a dry pump body is:
 Standard Pressure Impeller (8981-Series):
 Forward = 14.5 pounds force – feet
 Reverse = 43.0 pounds force – feet
- These values may vary slightly due to impeller compounding, blade set, and body material of construction. Consult factory for more information.
11. CLEANING – Before using pump, it should be disassembled and cleaned to remove any dust and dirt resulting from storage or shipping. Wash parts in standard cleaning solutions approved for handling stainless steel. Thoroughly rinse before reassembly. DO NOT USE IODINE BASED SANITIZERS as the iodine attacks the elastomer materials used in the impeller.

N.B. Do not clean with Phosphoric Acid.

All parts have been expertly machined and polished. HANDLE WITH CARE. DO NOT DROP OR MISHANDLE.

12. SPARE PARTS – To avoid costly shutdowns, keep a spare JABSCO impeller, seal and O-ring set on hand.

SERVICE INSTRUCTIONS

DISASSEMBLY

1. Remove the four end cover screws. Remove end cover and O-ring.
2. Remove the four screws, holding the body to the adapter flange. Slide body, complete with impeller and wearplate, from adapter and shaft.
3. Remove mechanical seal by inserting two screwdrivers behind seal collar, and gently lever collar and seal assembly forward on shaft. Use extreme care not to mar shaft surface. Remove seal seat and rubber cup from recess in wearplate.
4. Remove the four screws holding the adapter to the

motor and remove the adapter.

5. Stub shaft is held in place with set screws and Loctite* retaining compound. Extreme care must be taken not to damage the motor shaft and bearings when removing the stub shaft. Heat shaft joint area to facilitate disassembly of set screws and stub shaft from motor shaft. DO NOT EXCEED 350° F when heating joint area. Once joint area has been heated, remove set screws and slide stub shaft from motor shaft.

ASSEMBLY

1. Liberally apply Loctite RC/680 retaining compound to the motor shaft and slide the stub shaft on, positioning the base of the stub shaft 0.37" from the bolt mounting surface of motor and two of the four set screw holes over the keyway in the motor shaft. For clarification refer to figure 1 below. Loctite aids in preventing fretting and subsequent shaft failure. Wipe off excess Loctite. Apply Loctite to the two dog point (flat point) set screws, position in the set screw holes aligned with the keyway of the motor shaft and torque to 55 - 60 in. – lbs. Apply Loctite to the two cup point set screws and torque to 85 - 90 in. – lbs.
2. Replace the adapter on the motor and tighten the four mounting screws to 40 ft. – lbs.
3. Replace mechanical seal by sliding spacer onto shaft up to locating shoulder, then smear shaft with light lubricating oil. Push on seal gently until it engages with spacer. Fit rubber cup and seal seat into wearplate.
4. Insert impeller in pump body, fit O-ring in each end of the pump body.
5. Slide wearplate and body assembly over shaft, position wearplate in housing. Fit body to pedestal with screws. Torque screws to 60 in. – lbs. NOTE: A gap should be maintained between bearing housing and body. DO NOT overtighten screws.
6. Fit end cover and end cover screws. Torque screws to 10 in. – lbs.
7. Changing Pump Rotation (looking at end cover):
 - a. Clockwise Rotation: Insert impeller into pump body with blades bending counterclockwise
 - b. Counterclockwise Rotation: Insert impeller into pump body with blades bending clockwise.

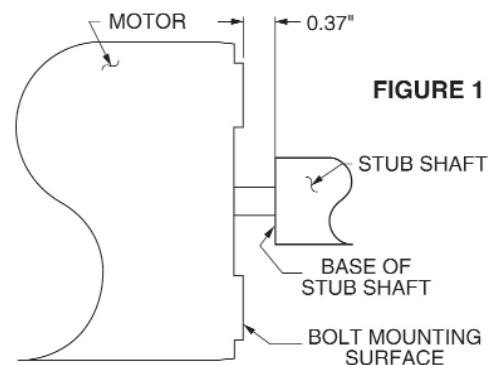

FIGURE 1

PARTS LIST

Jabsco Pumps 30570-2005

www.PumpAgents.com - Click here for Pricing/Ordering for Pumps and Parts

Key	Description	Qty.	Model	Model	Model	Model
			30570-2XXX	30570-3XXX	30570-4XXX	30570-5XXX
Req.	Part No.	Part No.	Part No.	Part No.	Part No.	Part No.
1	Adapter	1	18753-0217	18753-0217	18753-0217	18753-0217
2	Body:	1				
	2-A. Clamp Ports			18753-0365		18753-0365
	2-B. ACME Ports		18753-0366		18753-0366	
3	End Cover	1	18753-0367	18753-0367	18753-0367	18753-0367
4	Wearplate	1	18753-0201	18753-0201	18753-0201	18753-0201
5	Shaft	1	18753-0213	18753-0213	18753-0213	18753-0213
6	Impeller:	1				
	Standard Pressure – Neoprene		14346-0005	14346-0005	14346-0005	14346-0005
	Standard Pressure – EPDM		14346-0002	14346-0002	14346-0002	14346-0002
7	Motor: 1-1/2 HP, 115/230 Vac, 1 Ph, 60 Hz, TEFC, H145 TC Frame	1			18753-0220	18753-0220
8	Spacer	1	18753-0228	18753-0228	18753-0228	18753-0228
9	Seal Seat: Ceramic – Nitrile	1	18753-0237	18753-0237	18753-0237	18753-0237
10	Seal Mech.:	1				
	Carbon – Nitrile		18753-0249	18753-0249	18753-0249	18753-0249
	Tungsten Carbide – Nitrile		18753-0251	18753-0251	18753-0251	18753-0251
11	O-Ring: Nitrile	2	18753-0265	18753-0265	18753-0265	18753-0265
12	Screw Kit:	1	18753-0286	18753-0286	18753-0286	18753-0286
	Consists of					
	Screw, Hex Hd. 3/8-16x1"	(4)				
	Screw, Hex Hd. M6x16mm	(4)				
	Screw, Hex Hd. M6x10mm	(4)				
	Set Screw Dog Pt 1/4-20x1/2	(2)				
	Set Screw, Cup Pt. 1/4-20x3/8	(2)				
	Washer, Flat 3/8	(4)				
	Washer, Flat M6	(4)				

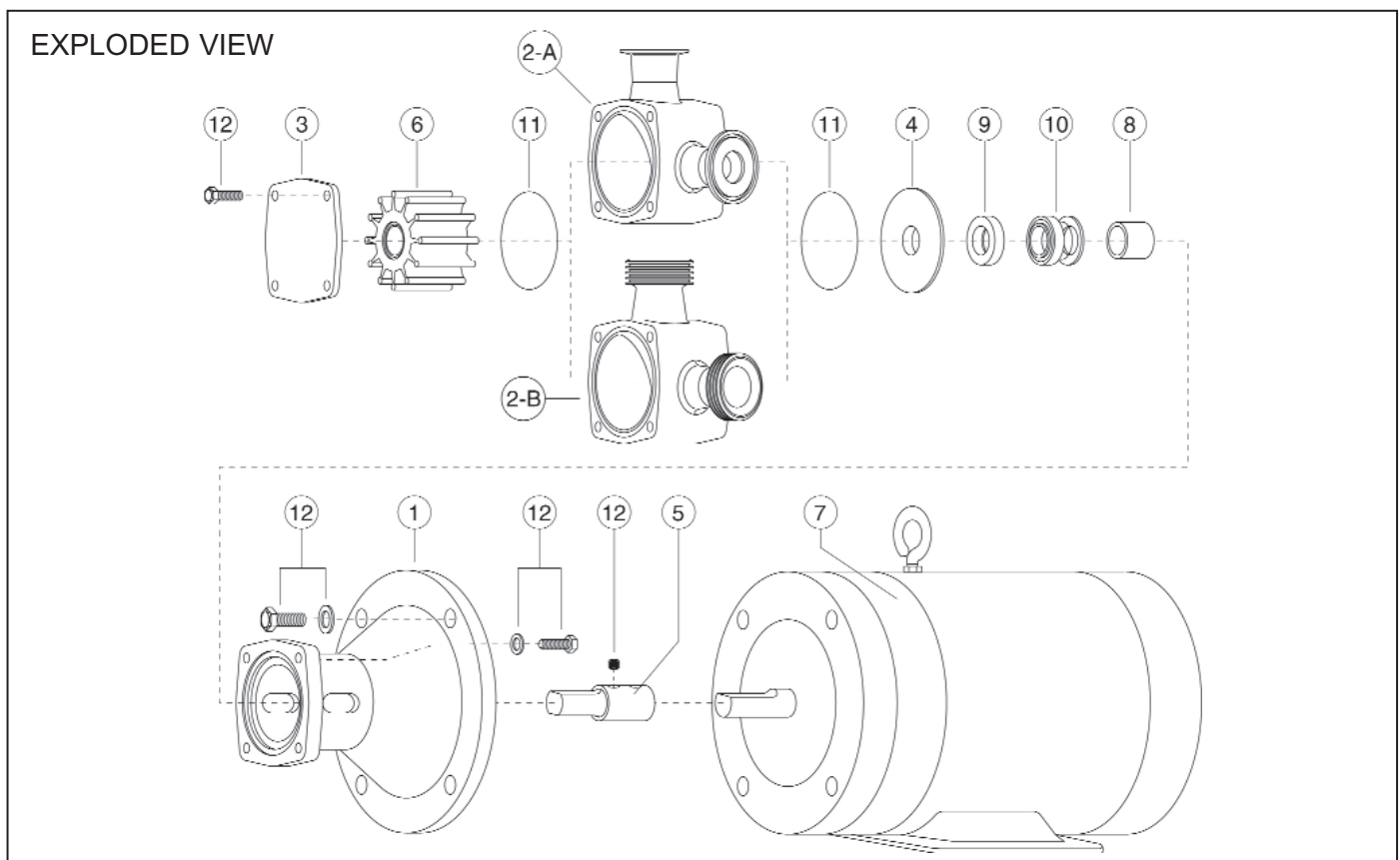

DIMENSIONAL DRAWING
Jabco Pumps 30570-2005
 Inches (Millimeters)
www.PumpAgents.com - Click here for Pricing/Ordering for Pumps and Parts

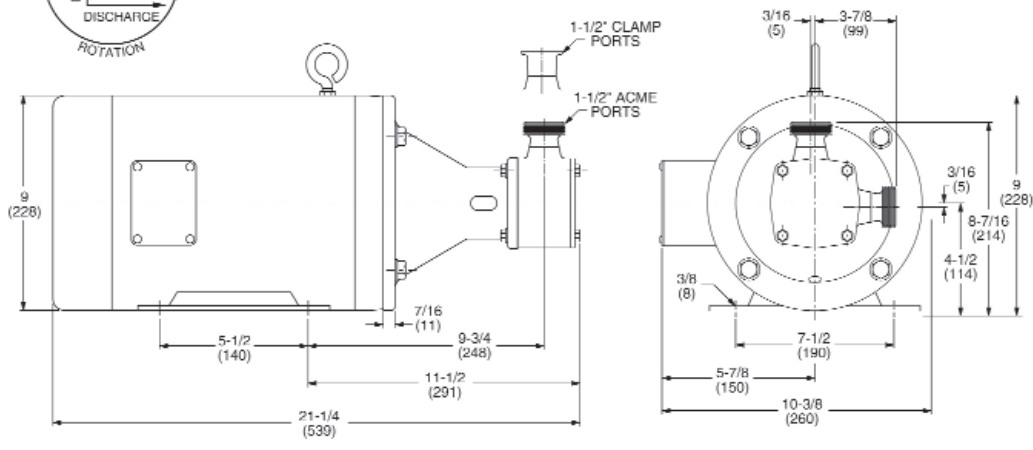

PERFORMANCE CURVES

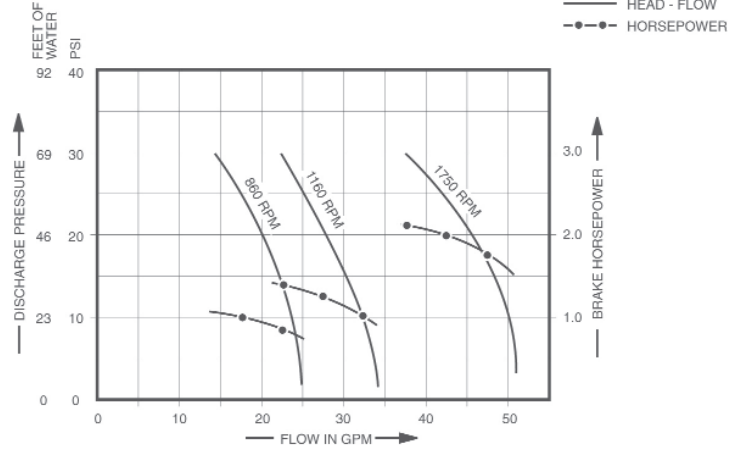

NOTE: Curves show approximate head flow for new pumps with neoprene pumping water.

PUMP SPEED SELECTION ACCORDING TO PRODUCT VISCOSITY

Viscosity S.S.U.	Pump Speed (Max. RPM)	Viscosity S.S.U.	Pump Speed (Max. RPM)	Viscosity S.S.U.	Pump Speed (Max. RPM)	Viscosity S.S.U.	Pump Speed (Max. RPM)
50	1750	700	1680	4,000	1400	15,000*	787
100	1750	800	1645	5,000	1312	20,000*	700
200	1750	900	1610	6,000	1225	30,000*	612
300	1750	1,000	1575	7,000	1138	40,000*	525
400	1750	1,500	1540	8,000	1050	50,000*	437
500	1750	2,000	1505	9,000	962	75,000*	298
600	1715	3,000	1450	10,000	875	100,000*	175

Consult factory for specific performance information. *Use High Pressure Impeller.

Let's Solve Water

Jabco , 1 Kondelin Road, Cape Ann Industrial Park, Gloucester, MA 01930 Tel: +1 978 281 0440 Fax: +1 978 283 2619	USA
Jabco , Bingley Road, Hoddesdon, Hertfordshire, EN11 0BU Tel: +44 (0) 1992 450 145 Fax: +44 (0) 1992 467 132	UK
NHK Jabco Co Ltd , 3-21-10, Shin - Yokohama Kohoku-ku, Yokohama 227 Tel: +81 (0) 45 475 8906 Fax: +81 (0) 45 475 8908	JAPAN
Jabco GmbH , Ostraße 28, 22844 Norderstedt Tel: +49 (0) 40 53 53 73 0 Fax: +49 (0) 49 53 53 73 11	GERMANY
Jabco Italia, s.r.l. , Via Iommaseo, 6, 20059 Vimercate, Milano Tel: +39 039 685 2323 Fax: +39 039 666 307	ITALY

Warranty: All products of the company are sold and all services of the company are offered subject to the company's warranty and terms and conditions of sale, copies of which will be furnished upon request. The information provided herein is for guidance only, it does not constitute a guarantee of the performance or specification of any individual product or component. © 2012 Xylem, Inc. All rights reserved. JABSCO is a registered trademark of Xylem Inc. or one of its subsidiaries.



Hygienic Flexible Impeller Pumps

Stainless Steel Close-Coupled Pumps

TECHNICAL DATA

PUMP MODEL NUMBER	30550-4005	30560-4005
FLOW (1750 RPM, 10 Ft. Head)	10 GPM	20 GPM
PORT SIZE	1"	1"
PORT TYPE	ACME Threaded	ACME Threaded
IMPELLER	Neoprene	Neoprene
SEAL SHAFT	Mechanical - C/C	Mechanical - C/C
BODY AND SHAFT MATERIAL	316 Stainless Steel	316 Stainless Steel
VOLTAGE	115 VAC, 60 Hz, 1 Ph,	115/230 VAC, 60 Hz, 1 Ph,
RPM	1750 RPM	1750 RPM
MOTOR TYPE	HP TEFC, 56 C frame	1 1/2 HP TEFC, 145 TC frame
SIZE (Height x Width x Length)	9 1/4" x 9" x 16"	9 1/2" x 9" x 18 3/4"
WEIGHT (Approx.)	36.0 lbs.	56.0 lbs.



30550-4005

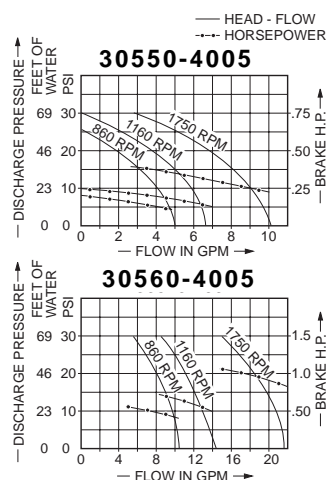

Variations Available

- 30550-4105 SP Neoprene Impeller, TC/C Seal, ACME Ports
- 30550-5005 SP Neoprene Impeller, C/C Seal, Clamp Ports
- 30550-5105 SP Neoprene Impeller, TC/C Seal, Clamp Ports
- 30550-2005 Pump Head, SP Neoprene Impeller, C/C Seal, ACME Ports
- 30550-2105 Pump Head, SP Neoprene Impeller, TC/C Seal, ACME Ports
- 30550-3005 Pump Head, SP Neoprene Impeller, C/C Seal, Clamp Ports
- 30550-3105 Pump Head, SP Neoprene Impeller, TC/C Seal, Clamp Ports

Variations Available

- 30560-4105 SP Neoprene Impeller, TC/C Seal, ACME Ports
- 30560-5005 SP Neoprene Impeller, C/C Seal, Clamp Ports
- 30560-5105 SP Neoprene Impeller, TC/C Seal, Clamp Ports
- 30560-2005 Pump Head, SP Neoprene Impeller, C/C Seal, ACME Ports
- 30560-2105 Pump Head, SP Neoprene Impeller, TC/C Seal, ACME Ports
- 30560-3005 Pump Head, SP Neoprene Impeller, C/C Seal, Clamp Ports
- 30560-3105 Pump Head, SP Neoprene Impeller, TC/C Seal, Clamp Ports



30560-4005

PUMP MODEL NUMBER	30570-4005
FLOW (1750 RPM, 10 Ft. Head)	50 GPM
PORT SIZE	1 1/2"
PORT TYPE	ACME Threaded
IMPELLER	Neoprene
SEAL SHAFT	Mechanical - C/C
BODY AND SHAFT MATERIAL	316 Stainless Steel
VOLTAGE	230 VAC, 60 Hz, 3 Ph, 1750 RPM
MOTOR TYPE	5 HP TEFC, 184 TC frame
SIZE (Height x Width x Length)	9" x 10 1/2" x 21 3/4"
WEIGHT (Approx.)	93.5 lbs.



30570-4005

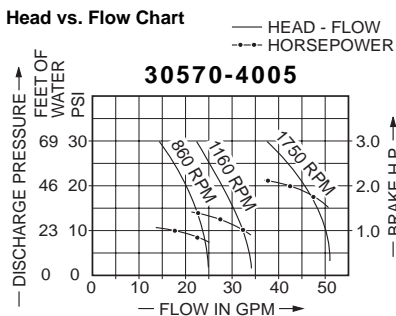

Variations Available

- 30570-4105 SP Neoprene Impeller, TC/C Seal, ACME Ports
- 30570-5005 SP Neoprene Impeller, C/C Seal, Clamp Ports
- 30570-5105 SP Neoprene Impeller, TC/C Seal, Clamp Ports
- 30570-2005 Pump Head, SP Neoprene Impeller, C/C Seal, ACME Ports
- 30570-2105 Pump Head, SP Neoprene Impeller, TC/C Seal, ACME Ports
- 30570-3005 Pump Head, SP Neoprene Impeller, C/C Seal, Clamp Ports
- 30570-3105 Pump Head, SP Neoprene Impeller, TC/C Seal, Clamp Ports

Performance curves show approximate flow in U.S. Gallons Per Minute for a new pump with a Neoprene Impeller. For Metric conversion of flows and dimensions refer to Engineering Data. Use only capacitor-start motors with flexible impeller pumps.