

Base Mounted Turbine Pumps

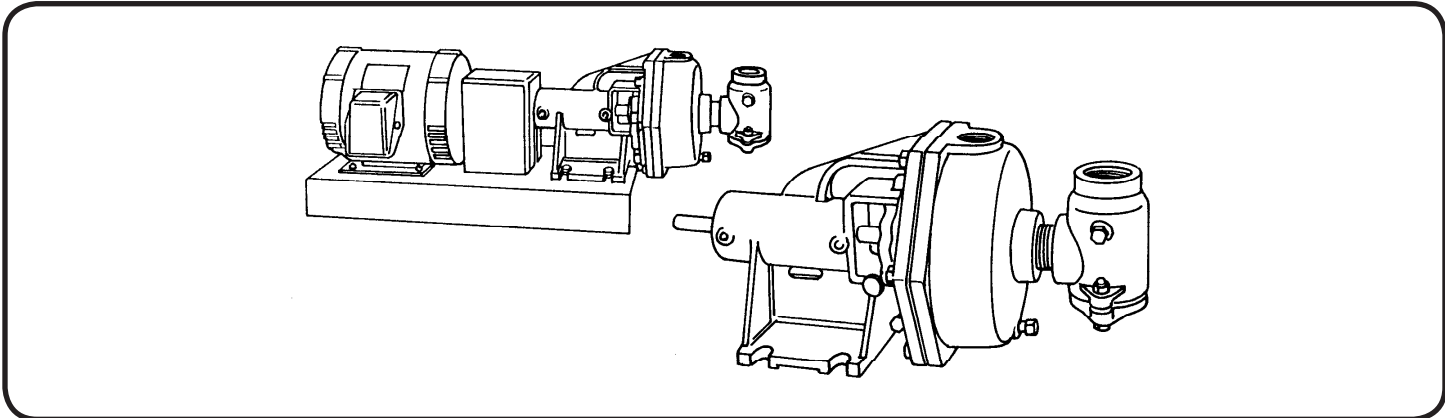

EC & ED - 1725 RPM - 60Hz.
(See Individual curves for symbol number)

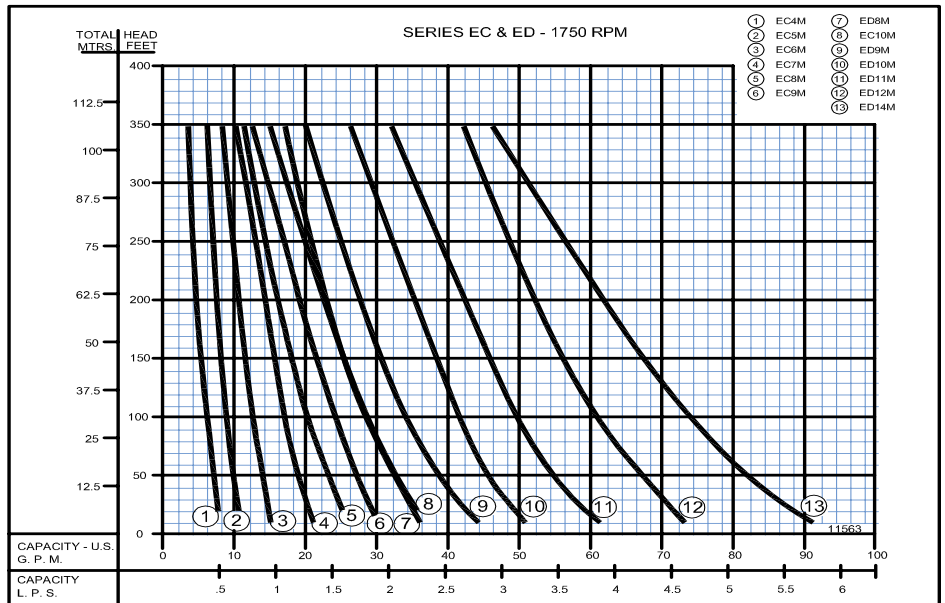

EC & ED - 1450 RPM - 50Hz.
(See Individual curves for symbol number)

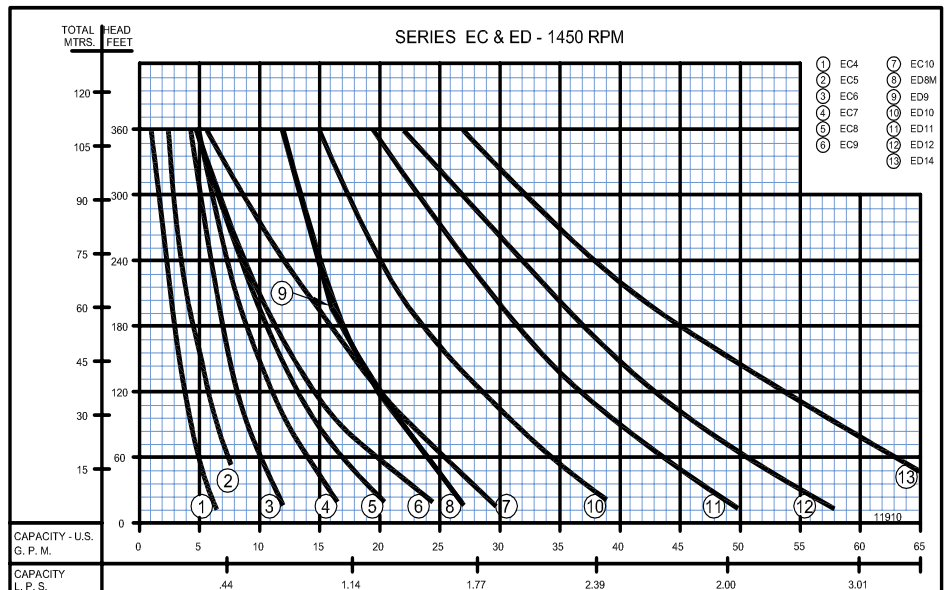

Individual performance curves should be checked for final selection.

Base Mounted Turbine Pumps

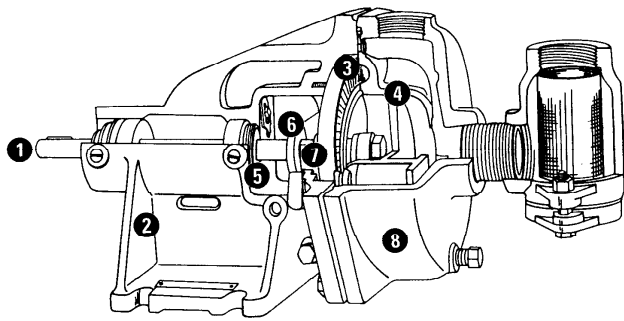

BURKS Turbine Pumps are designed for pumping any clean, non-corrosive, non-abrasive lower viscosity liquid on low flow, high head applications. They are used in a wide range of industries.

- BOILER FEED
- CONDENSATED RETURN
- HEAT TRANSFER
- HOT AND COLD WATER CIRCULATION
- JOCKEY PUMP
- HYDRAULIC OIL CIRCULATION
- HIGH PRESSURE SPRAY
- BRINE CIRCULATION
- PRESSURE BOOSTER
- ADDITIVE METERING

1. PUMP SHAFT
No. 303 stainless steel

2. POWER FRAMES
Power frames are supplied with grease lubricated ball bearings. Wide bearing spacing provides solid shaft support. Tapped and plugged openings are conveniently located for easy relubrication of power frame. Grease relief holes prevent over-lubrication.

3. IMPELLER
The bronze impeller, with monel metal blades secured in slots in the liquid channel by means of a brazing process, is the only moving part. Annular grooves or sealing rings are machined in the face of the impeller. These grooves are perfectly matched with corresponding grooves in the raceway and intermesh without metal to metal contact to form a labyrinth seal.

4. RACEWAY
The bronze raceway is the mating part to the impeller. Sealing grooves are machined into the face of the raceway to match the impeller sealing grooves reducing water slippage to a minimum, resulting in better efficiencies, while reducing the possibility of vapor bind.

5. "LIFE-LOK"® EXTERNAL ADJUSTMENT
The adjusting screw is located in the power frame on Independent Pumps. A positive pre-load spring pressure is applied to the pump shaft bearing and in turn, is transmitted to the adjusting screw. This controlled pressure eliminates bearing end-play and provides a means for external adjustment of the clearance between the impeller and raceway. The distinct advantage of this exclusive BURKS feature is the positive means provided to establish the initial clearance between the impeller and raceway, plus providing a means for external readjustment to compensate for any possible wear between these parts. The customer benefit of this exclusive feature is the fact that readjustment can be made without disassembling the pump or disturbing the piping.

6. MECHANICAL SHAFT SEAL

The leakproof mechanical shaft seal for temperatures to 225°F (107°C), is self-adjusting. A wide variety of mechanical seals are available for handling liquids other than water.

7. JACKETED SEAL CAVITY FOR TEMPERATURES TO 500°F (260°C)

Series EC & ED Pumps are available in a Jacketed Seal Cavity design for pumping hot oil, hot water and heat transfer fluids in common use in high temperature heating or cooling applications. This feature greatly extends seal life in high temperature applications. To order, add suffix "J" to pump catalog number for temperatures below 400°F (204°C) and add suffix "JK" to pump catalog number for temperatures over 400°F (204°C). Example: EC6MJ. See Section on High Temperature Pumps for more information.

8. CASING

Casing is close grain iron of 30,000 p.s.i. minimum tensile strength. Should the pump require service there's no need to disturb the piping - the casing stays in the line.

9. SELF PRIMING

Once casing is filled with water - will handle water, air or a mixture of both to high pressure.

10. FACTORY TESTED

Every pump factory tested for capacity, head and power consumption.

MAXIMUM OPERATING CONDITIONS	
HORSEPOWER WITH C POWER FRAME	5 HP
HORSEPOWER WITH D POWER FRAME	15 HP
TEMPERATURE (For Standard Buna-N Seal)	225°F (107°C)
INLET PRESSURE	50 PSI (344kPa)
CASING WORKING PRESSURE	200 PSI (1379kPa)

INTERCHANGEABILITY CHART			
Catalog No.	Replaces	Catalog No.	Replaces
EC4M	E16M	ED8M	E23M
EC5M	EC17M	ED9M	E24M
EC6M	E18M	ED10M	E25M
EC7M	E19M	ED11M	E26M
EC8M	E20M	ED12M	E27M
EC9M	E21M	ED14M	E29M
EC10M	E22M		

MATERIALS OF CONSTRUCTION		
PART	BRONZE FITTED	ALL BRONZE
Power Frame	Cast Iron	Bronze
Casing	Cast Iron	Bronze
Strainer	Cast Iron (Brass Screen)	Bronze (Brass Screen)
Impeller	Bronze (Monel Blades)	Bronze (Monel Blades)
Raceway	Bronze	Bronze
Shaft	#303 Stainless	#303 Stainless
Shaft Seal	Carbon-Ceramic SS - Buna-N	Carbon-Ceramic SS - Buna-N

Base Mounted Turbine Pumps

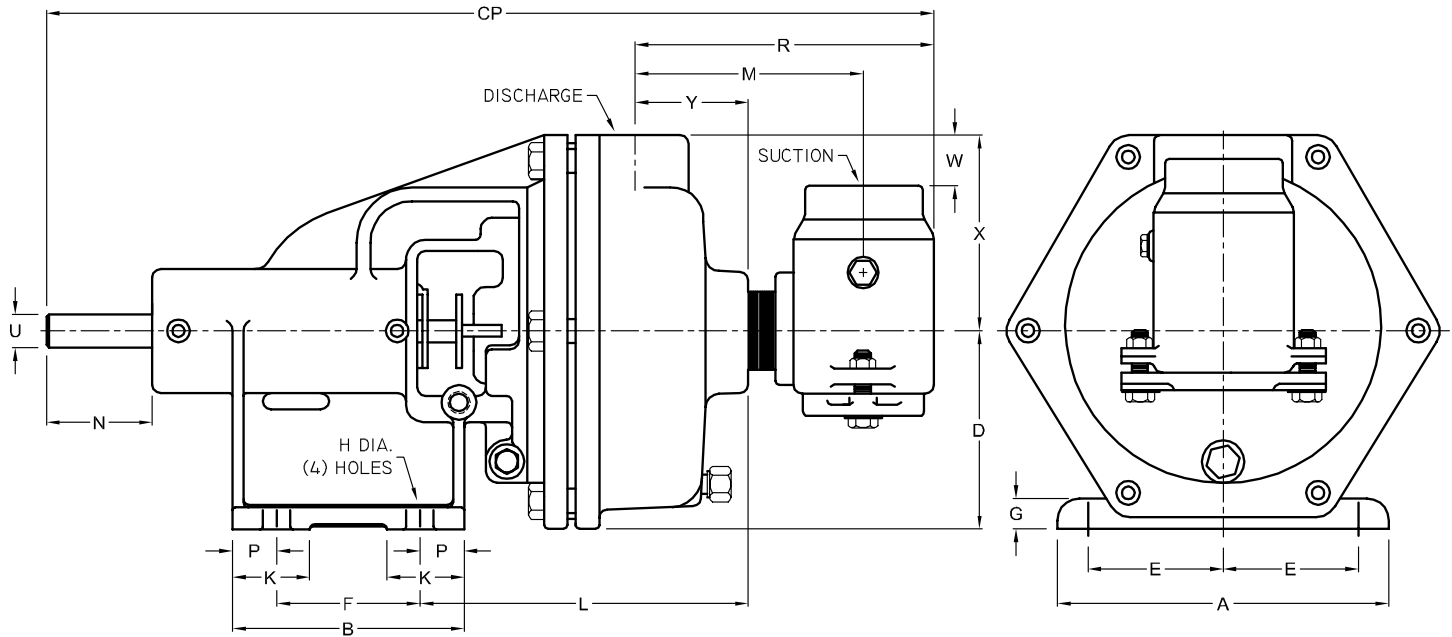

DIMENSIONS IN INCHES (mm)																				
PUMP	A	B	CP	D	E	F	G	H	K	L	M	N	P	R	U	W	X	Y	Suc.	Dis.
EC	7 (177)	5¼ (133)	20½ (511)	4½ (114)	2 ¹⁵ / ₁₆ (74)	¾ (82)	½ (13)	9/16 (14)	1¼ (44)	7 ⁷ / ₁₆ (188)	5 ³ / ₁₆ (131)	2 ⁵ / ₁₆ (60)	1 (25)	6 ¹³ / ₁₆ (173)	¾ (19)	1/8 (28)	4½ (114)	2 ⁹ / ₁₆ (65)	1½ NPT	1¼ NPT
ED	7 (177)	5¼ (133)	25 ³ / ₁₆ (639)	5¼ (133)	2 ¹⁵ / ₁₆ (74)	¾ (82)	½ (13)	9/16 (14)	1¼ (44)	9 (228)	7 ¹ / ₁₆ (179)	3 ¹ / ₁₆ (79)	1 (25)	9¼ (234)	1/8 (28)	½ (13)	5¼ (133)	2 ¹⁵ / ₁₆ (74)	2½ NPT	2 NPT

A strainer, approximately 20 mesh, should be installed on the suction side of the pump to prevent chips, scale or hard foreign particales from entering the pump and damaging the raceway and impeller.

Base Mounted Turbine Pumps

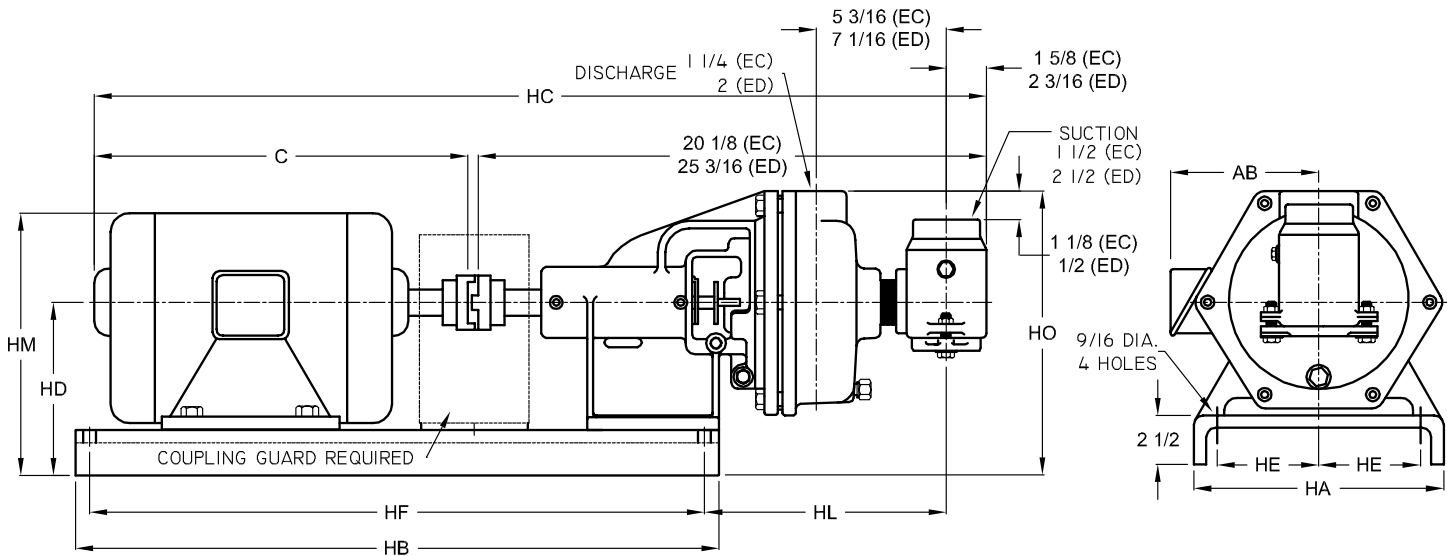

DIMENSIONS IN INCHES (mm)												
Pump	Motor Frame	AB	C	HA	HB	HC	HD	HE	HF	HL	HM	HO
EC	56	---	11 ⁷ / ₁₆ (290)	9 (228)	23 ¹ / ₂ (596)	32 ¹ / ₁₆ (814)	7 (177)	3 (76)	16 ¹ / ₄ (412)	15 ⁵ / ₁₆ (388)	10 ³ / ₁₆ (258)	11 ¹ / ₂ (292)
	143T	6 ³ / ₁₆ (157)	10 ¹¹ / ₁₆ (271)	9 (228)	23 ¹ / ₂ (596)	31 ¹ / ₁₆ (795)	7 (177)	3 (76)	16 ¹ / ₄ (412)	15 ⁵ / ₁₆ (388)	10 ⁵ / ₁₆ (261)	11 ¹ / ₂ (292)
	145T	6 ³ / ₁₆ (157)	11 ¹ / ₁₆ (296)	9 (228)	23 ¹ / ₂ (596)	32 ⁵ / ₁₆ (820)	7 (177)	3 (76)	16 ¹ / ₄ (412)	15 ⁵ / ₁₆ (388)	10 ⁵ / ₁₆ (261)	11 ¹ / ₂ (292)
	182T	7 ⁷ / ₁₆ (182)	12 ³ / ₄ (323)	10 (254)	26 ¹ / ₂ (673)	33 ³ / ₈ (854)	7 (177)	4 (101)	19 ¹ / ₄ (488)	15 ⁵ / ₁₆ (388)	11 ¹ / ₁₆ (287)	11 ¹ / ₂ (292)
	184T	7 ⁷ / ₁₆ (182)	13 ¹ / ₁₆ (347)	10 (254)	26 ¹ / ₂ (673)	34 ¹ / ₁₆ (877)	7 (177)	4 (101)	19 ¹ / ₄ (488)	15 ⁵ / ₁₆ (388)	11 ¹ / ₁₆ (287)	11 ¹ / ₂ (292)
	213T	7 ¹⁵ / ₁₆ (201)	15 ¹¹ / ₁₆ (398)	12 (304)	30 ¹ / ₄ (768)	36 ⁹ / ₁₆ (928)	7 ³ / ₄ (196)	5 (127)	28 ¹ / ₄ (717)	10 ¹ / ₁₆ (255)	12 ³ / ₁₆ (309)	13 (330)
	215T	7 ¹⁵ / ₁₆ (201)	17 ³ / ₁₆ (436)	12 (304)	30 ¹ / ₄ (768)	38 ¹ / ₁₆ (966)	7 ³ / ₄ (196)	5 (127)	28 ¹ / ₄ (717)	10 ¹ / ₁₆ (255)	12 ³ / ₁₆ (309)	13 (330)
ED	143T	6 ³ / ₁₆ (157)	10 ¹¹ / ₁₆ (271)	9 (228)	24 ³ / ₄ (628)	36 ³ / ₈ (923)	7 ³ / ₄ (196)	3 (76)	17 ¹ / ₂ (444)	18 ³ / ₈ (466)	11 ¹ / ₁₆ (280)	13 (330)
	145T	6 ³ / ₁₆ (157)	11 ¹ / ₁₆ (296)	9 (228)	24 ³ / ₄ (628)	37 ³ / ₈ (949)	7 ³ / ₄ (196)	3 (76)	17 ¹ / ₂ (444)	18 ³ / ₈ (466)	11 ¹ / ₁₆ (280)	13 (330)
	182T	7 ⁷ / ₁₆ (182)	12 ³ / ₄ (323)	10 (254)	28 (711)	38 ⁷ / ₁₆ (976)	7 ³ / ₄ (196)	4 (101)	20 ³ / ₄ (527)	18 ³ / ₈ (466)	12 ¹ / ₁₆ (306)	13 (330)
	184T	7 ⁷ / ₁₆ (182)	13 ¹ / ₁₆ (347)	10 (254)	28 (711)	39 ³ / ₈ (1000)	7 ³ / ₄ (196)	4 (101)	20 ³ / ₄ (527)	18 ³ / ₈ (466)	12 ¹ / ₁₆ (306)	13 (330)
	213T	7 ⁷ / ₁₆ (185)	15 ¹ / ₁₆ (398)	12 (304)	31 ³ / ₄ (806)	41 ⁵ / ₈ (1057)	7 ³ / ₄ (196)	5 (127)	29 ³ / ₄ (755)	13 ³ / ₈ (333)	12 ¹³ / ₁₆ (325)	13 (330)
	215T	7 ⁷ / ₁₆ (185)	17 ³ / ₁₆ (436)	12 (304)	31 ³ / ₄ (806)	43 ³ / ₈ (1095)	7 ³ / ₄ (196)	5 (127)	29 ³ / ₄ (755)	13 ³ / ₈ (333)	12 ¹³ / ₁₆ (325)	13 (330)
	254T	10 (254)	20 ⁹ / ₁₆ (522)	14 (355)	36 (914)	46 ⁵ / ₈ (1184)	8 ³ / ₄ (222)	5 (127)	34 (863)	13 ³ / ₈ (333)	14 ⁵ / ₈ (371)	14 (355)
	256T	10 (254)	20 ⁹ / ₁₆ (522)	14 (355)	36 (914)	48 ³ / ₈ (1228)	8 ³ / ₄ (222)	5 (127)	34 (863)	13 ³ / ₈ (333)	14 ⁵ / ₈ (371)	14 (355)

Dimensions based on ODP 3 Phase Motors.
56 Motor Frame only based on 1 Phase 3/4 HP. Max.

A strainer, approximately 20 mesh, should be installed on the suction side of the pump to prevent chips, scale or hard foreign particales from entering the pump and damaging the raceway and impeller.

Base Mounted Turbine Pumps

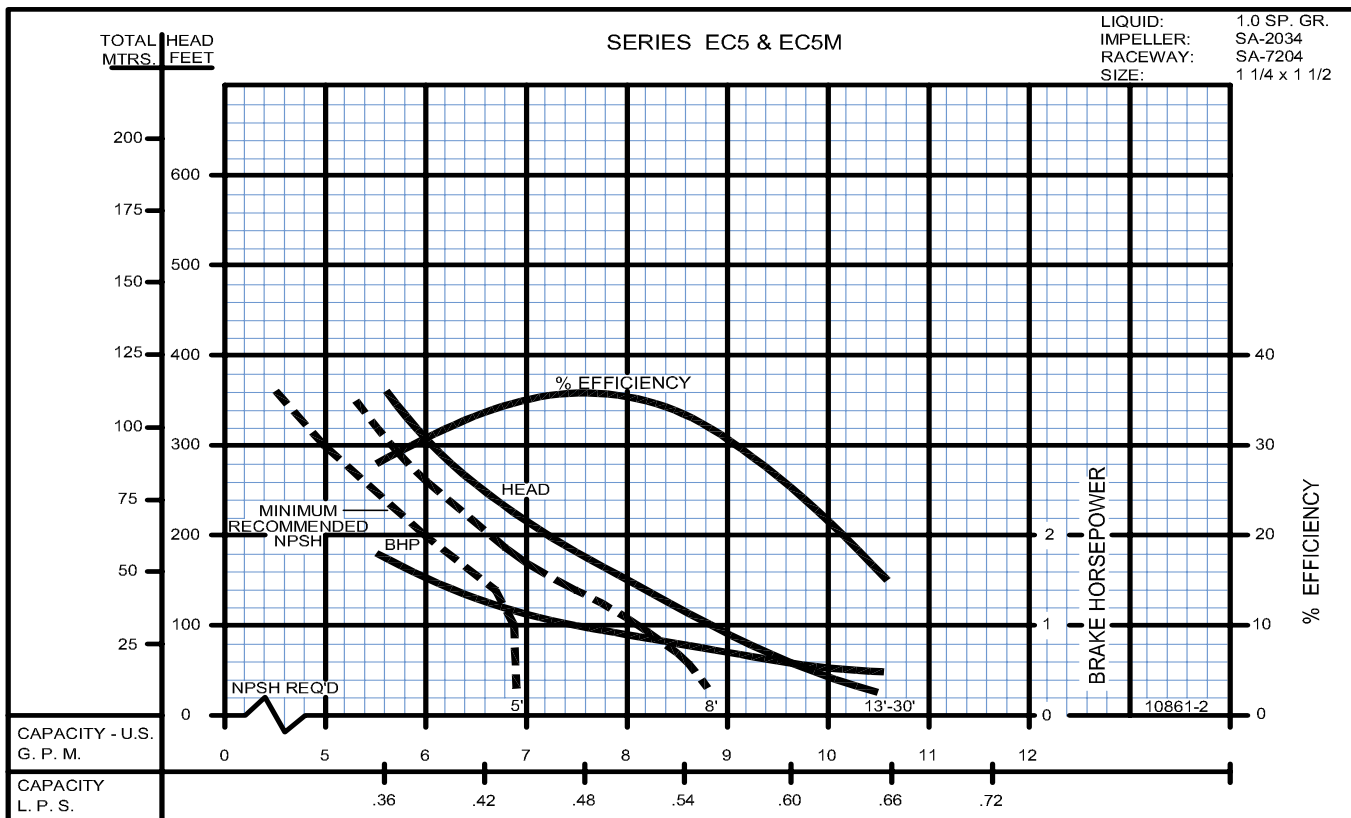
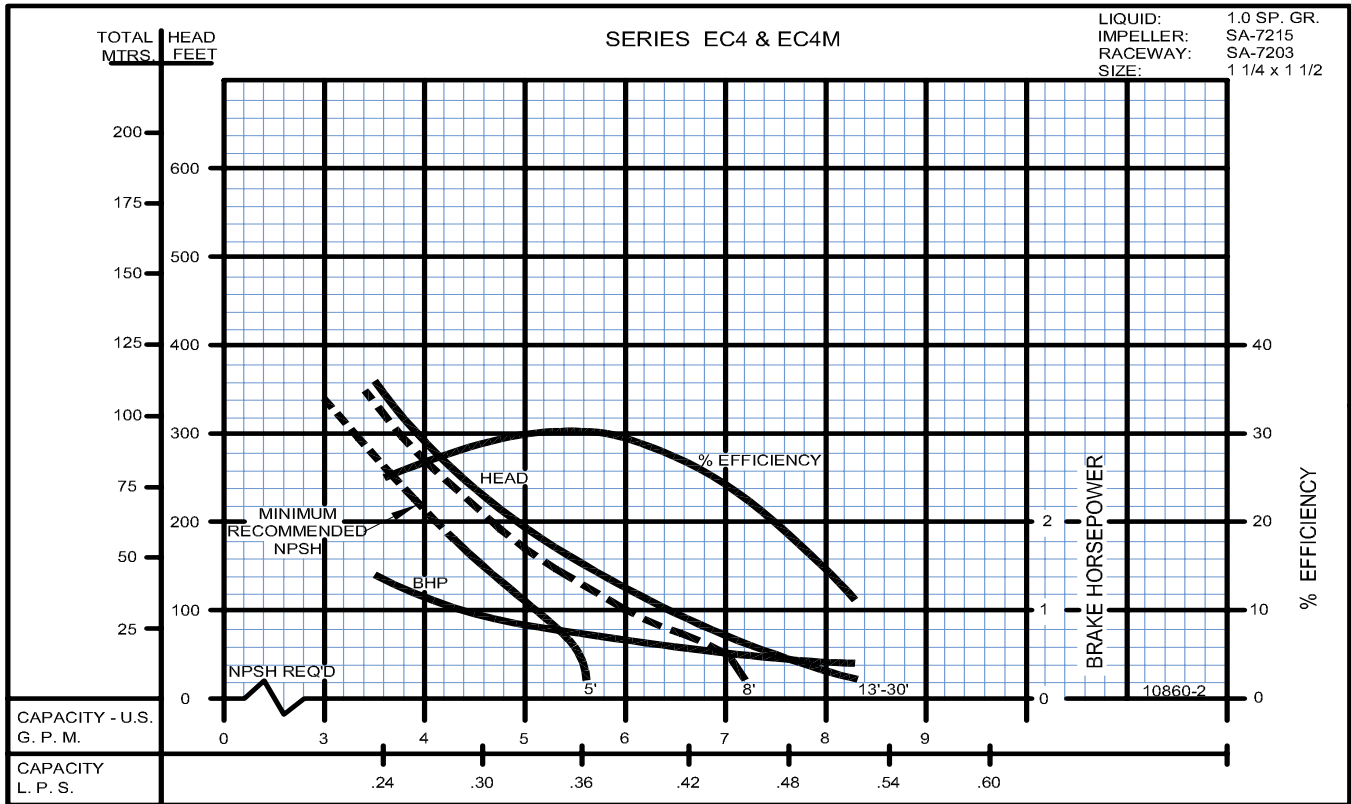

Base Mounted Turbine Pumps

1750 RPM

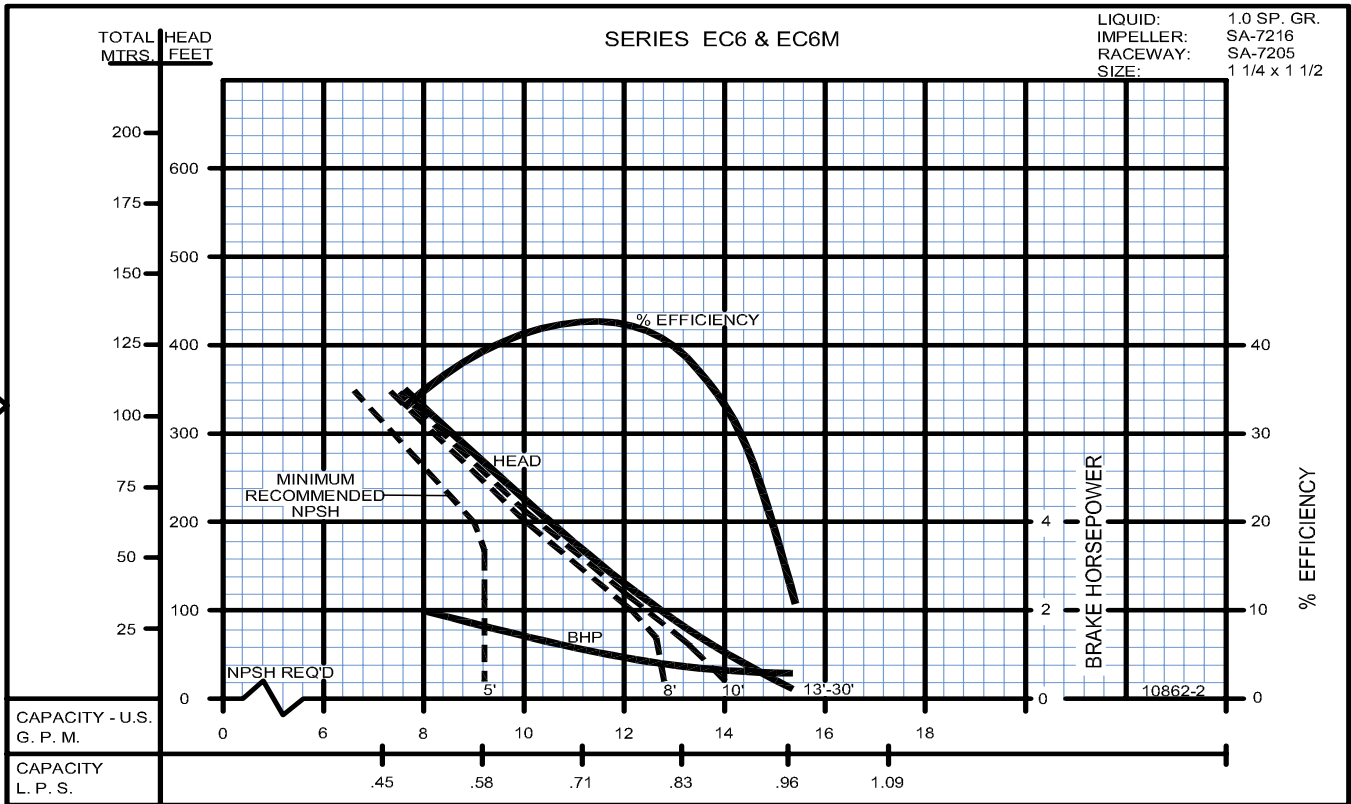

1750 RPM

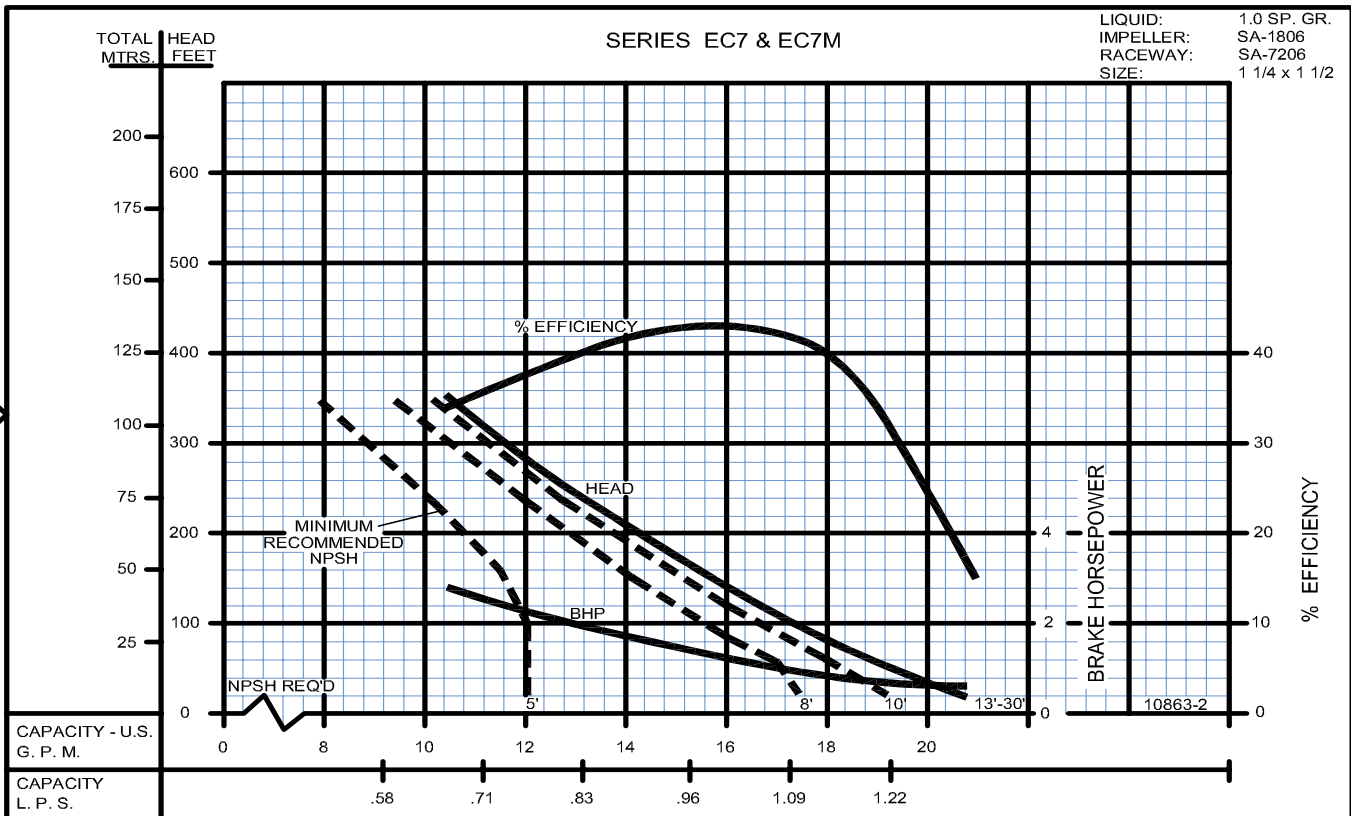

SECTION 6C
PAGE 6
DATE 1/06

CRANE[®]

A Crane Co. Company

PUMPS & SYSTEMS

USA: (937) 778-8947 • Canada: (905) 457-6223 • International: (937) 615-3598

Base Mounted Turbine Pumps

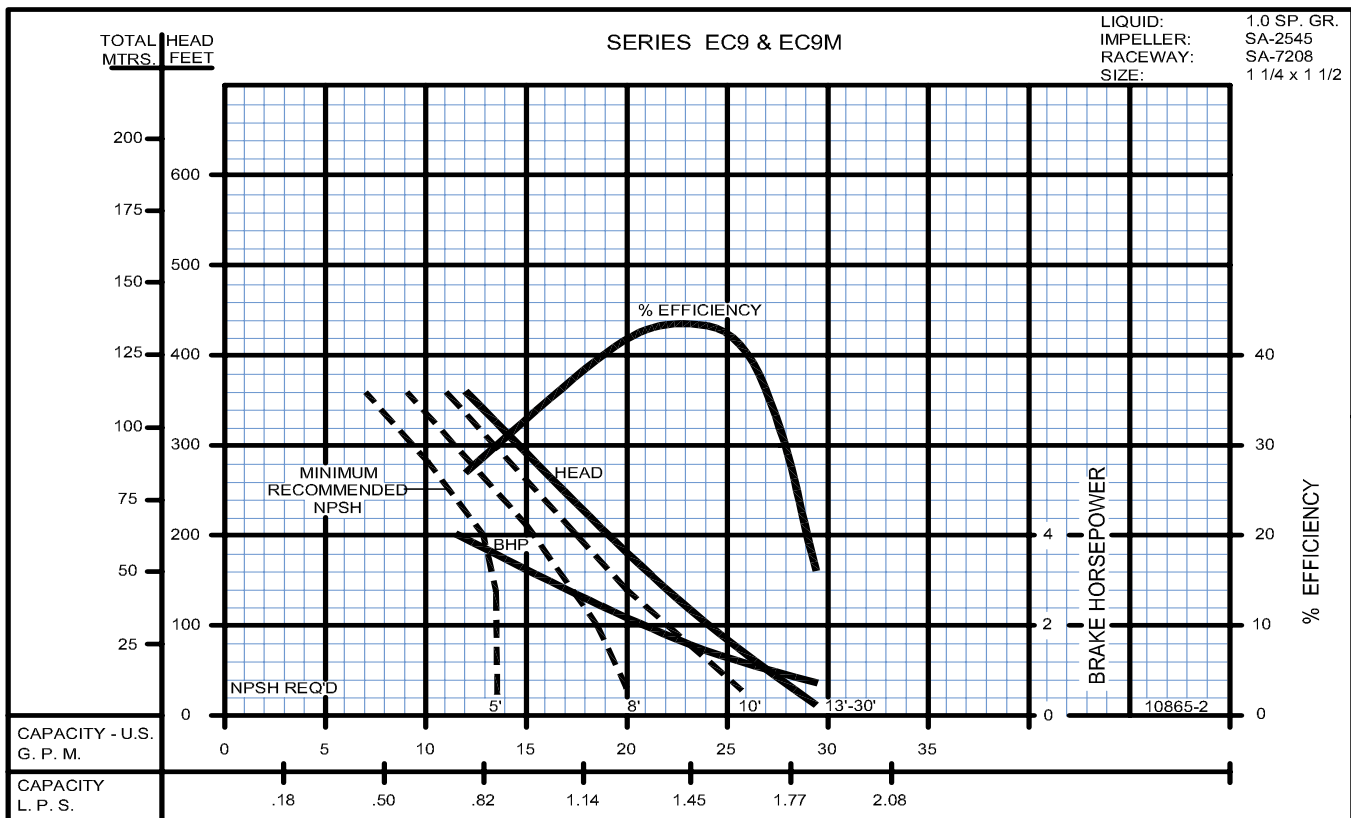
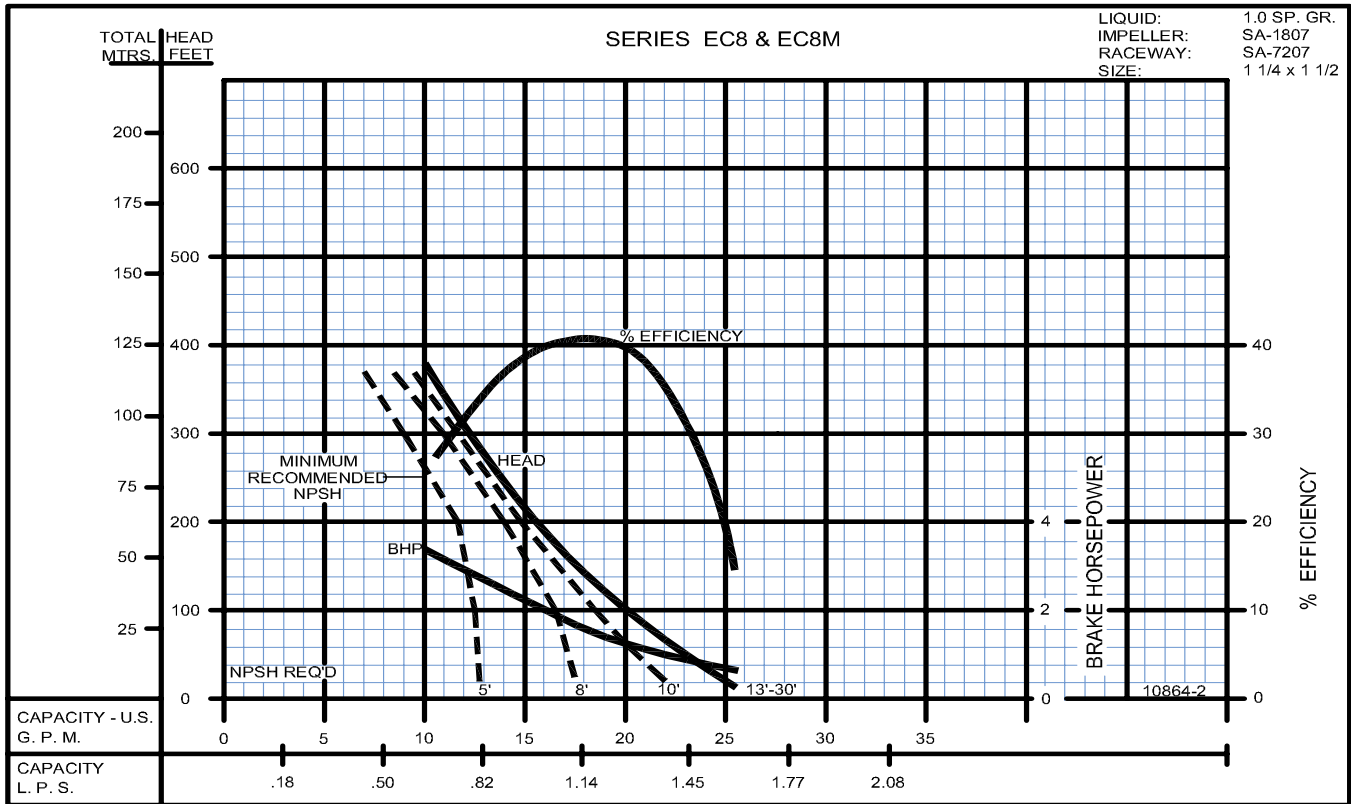

Base Mounted Turbine Pumps

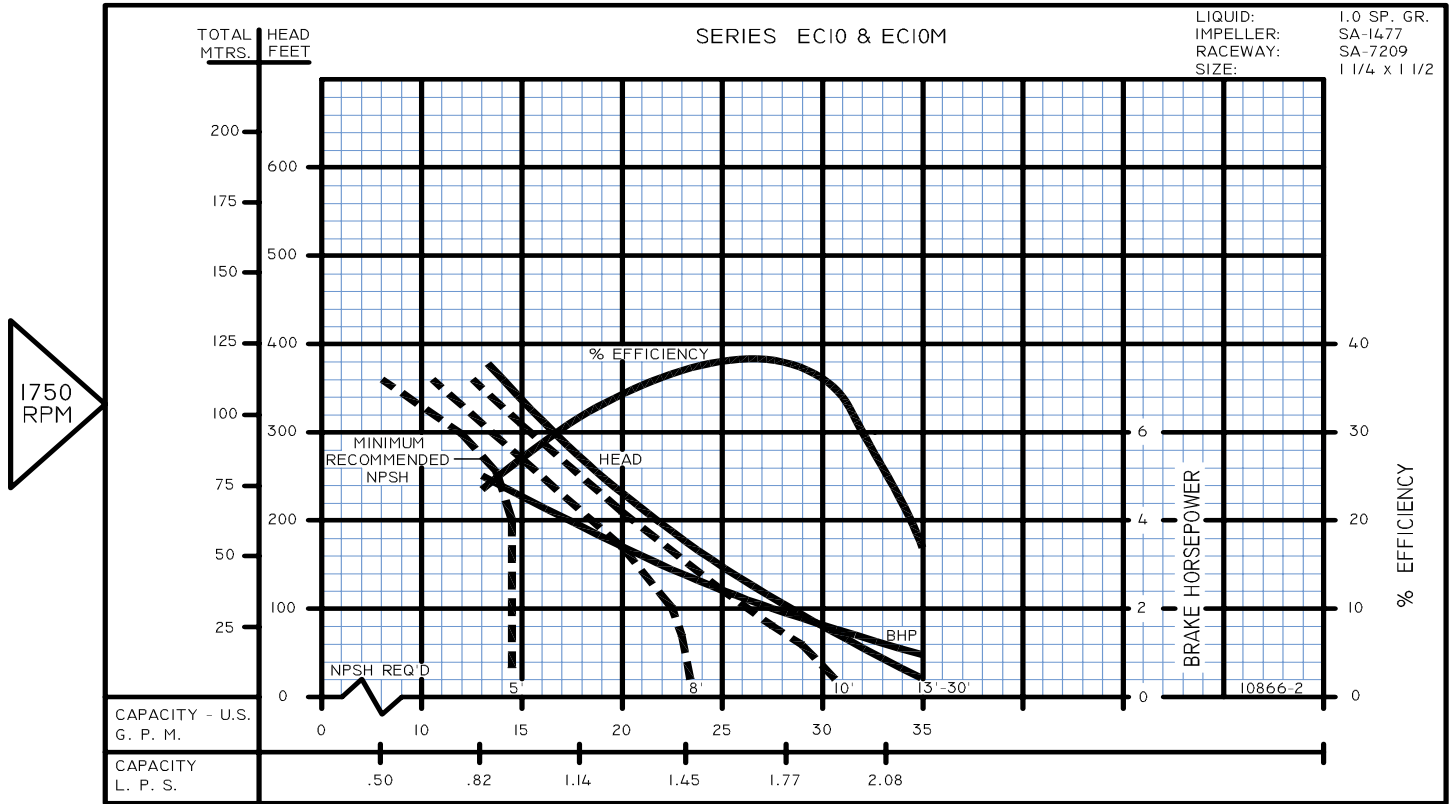

Base Mounted Turbine Pumps

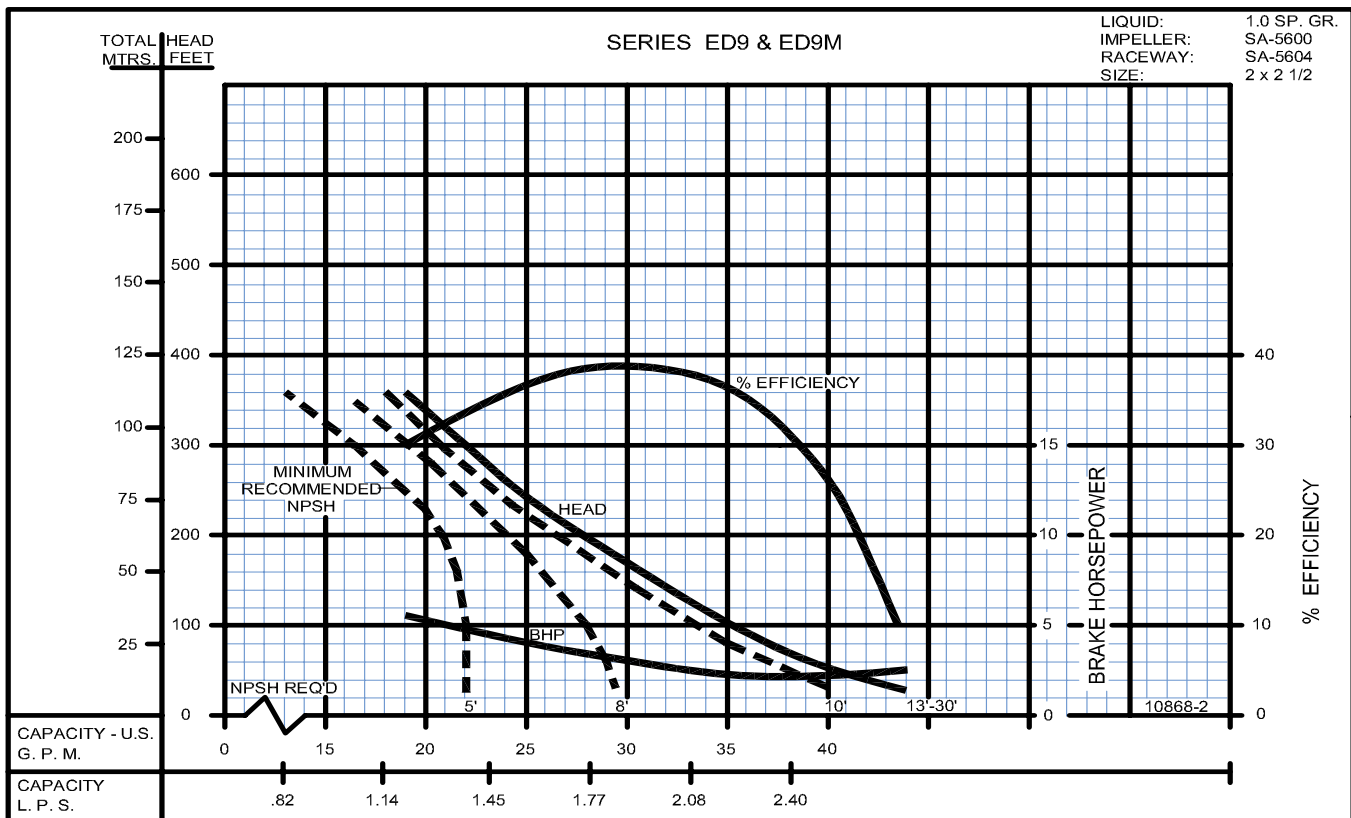
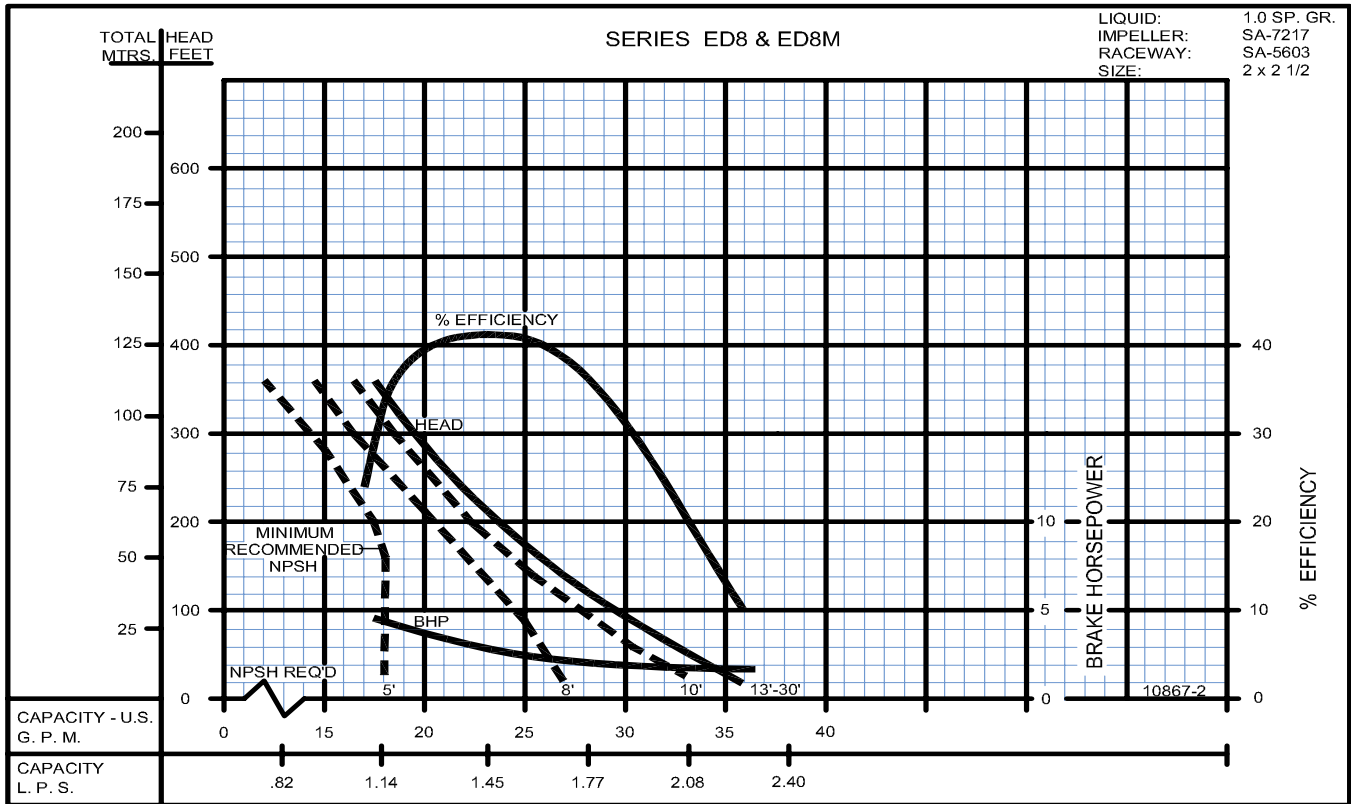

Base Mounted Turbine Pumps

1750 RPM

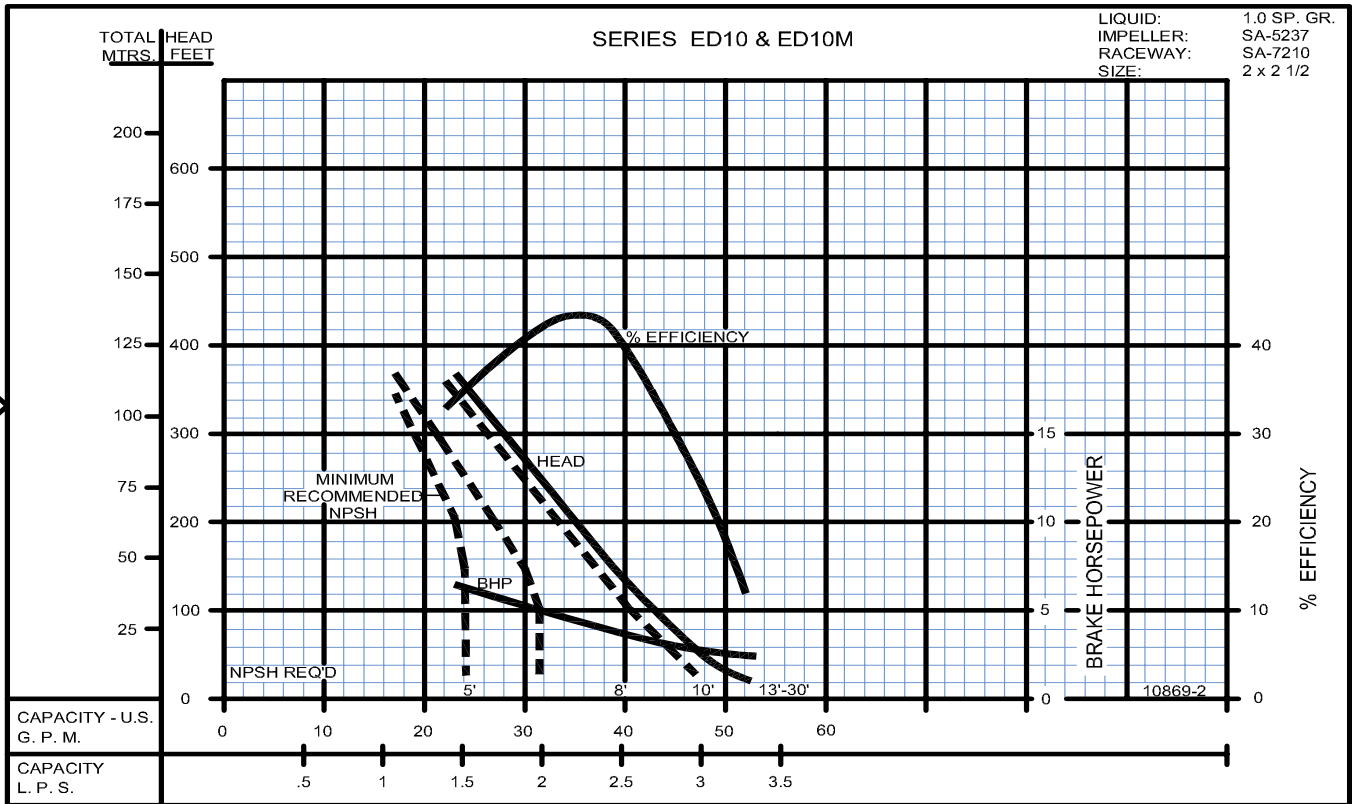

1750 RPM

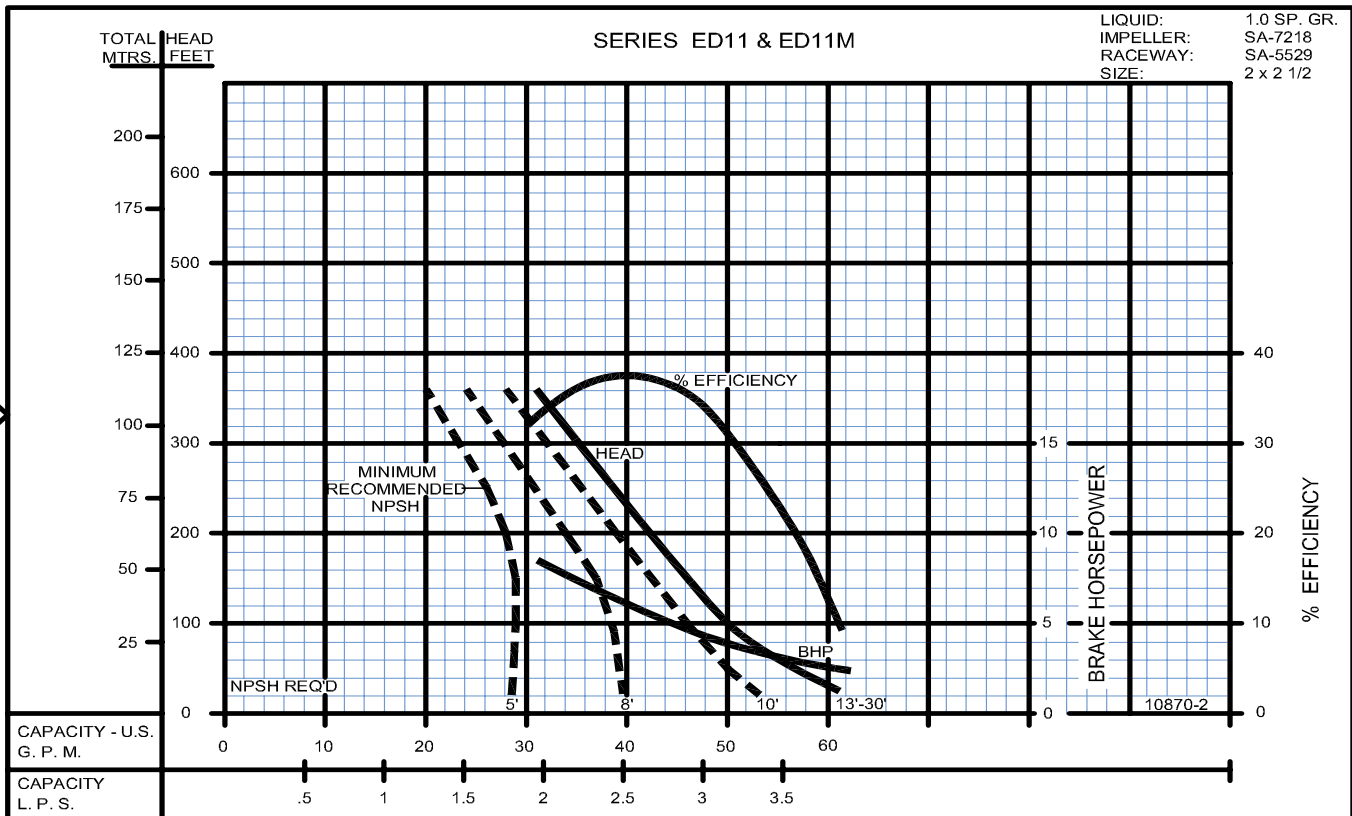

SECTION 6C
PAGE 10
DATE 1/06



A Crane Co. Company

PUMPS & SYSTEMS

USA: (937) 778-8947 • Canada: (905) 457-6223 • International: (937) 615-3598

Base Mounted Turbine Pumps

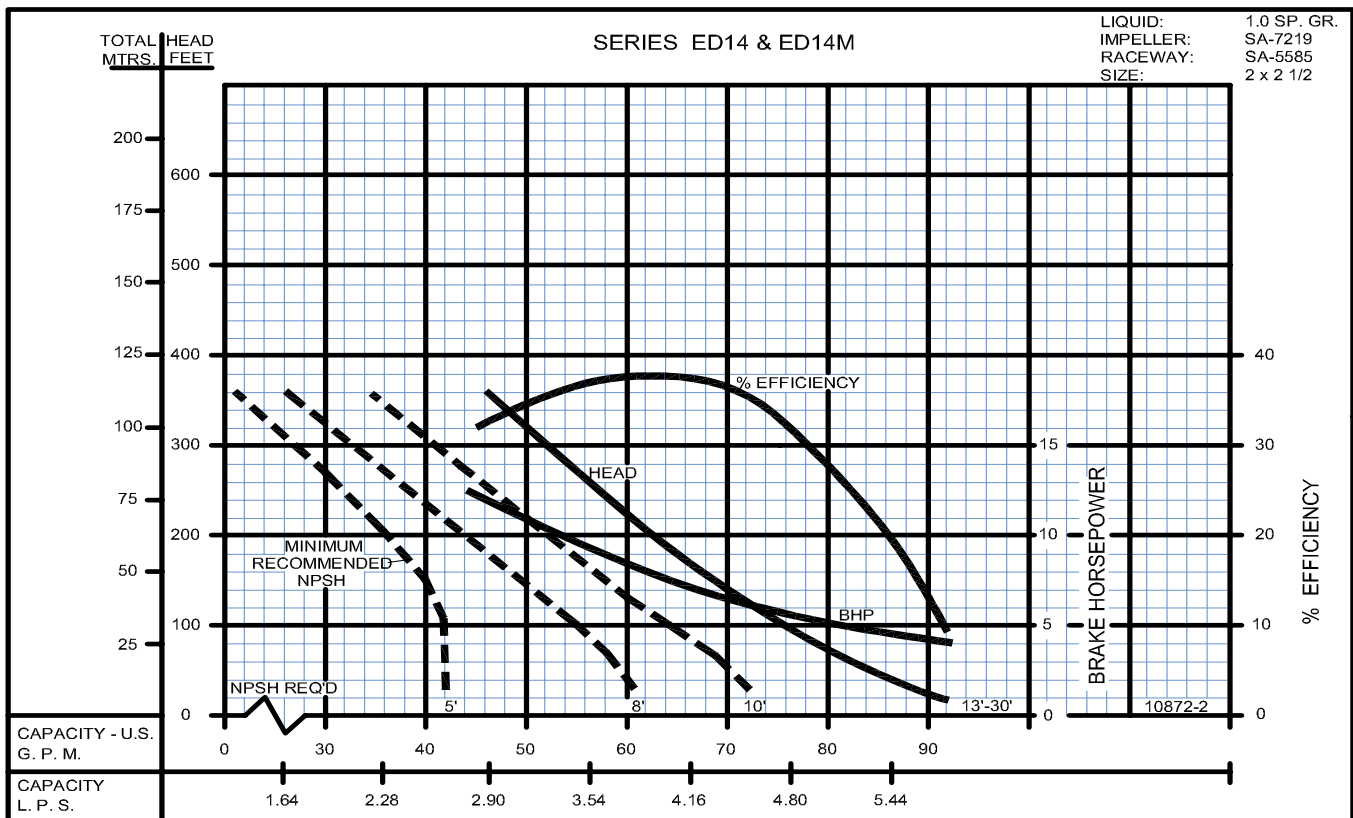
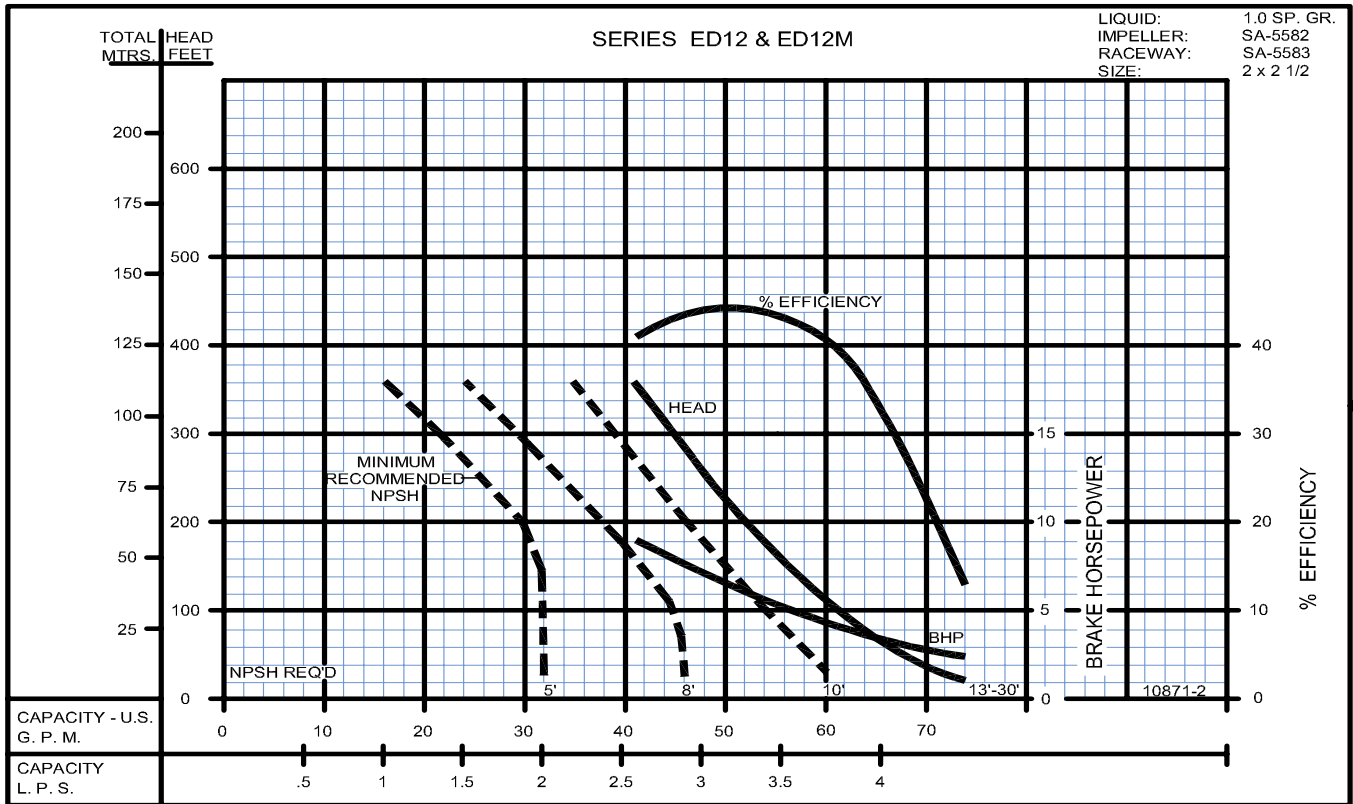

Base Mounted Turbine Pumps

1450 RPM

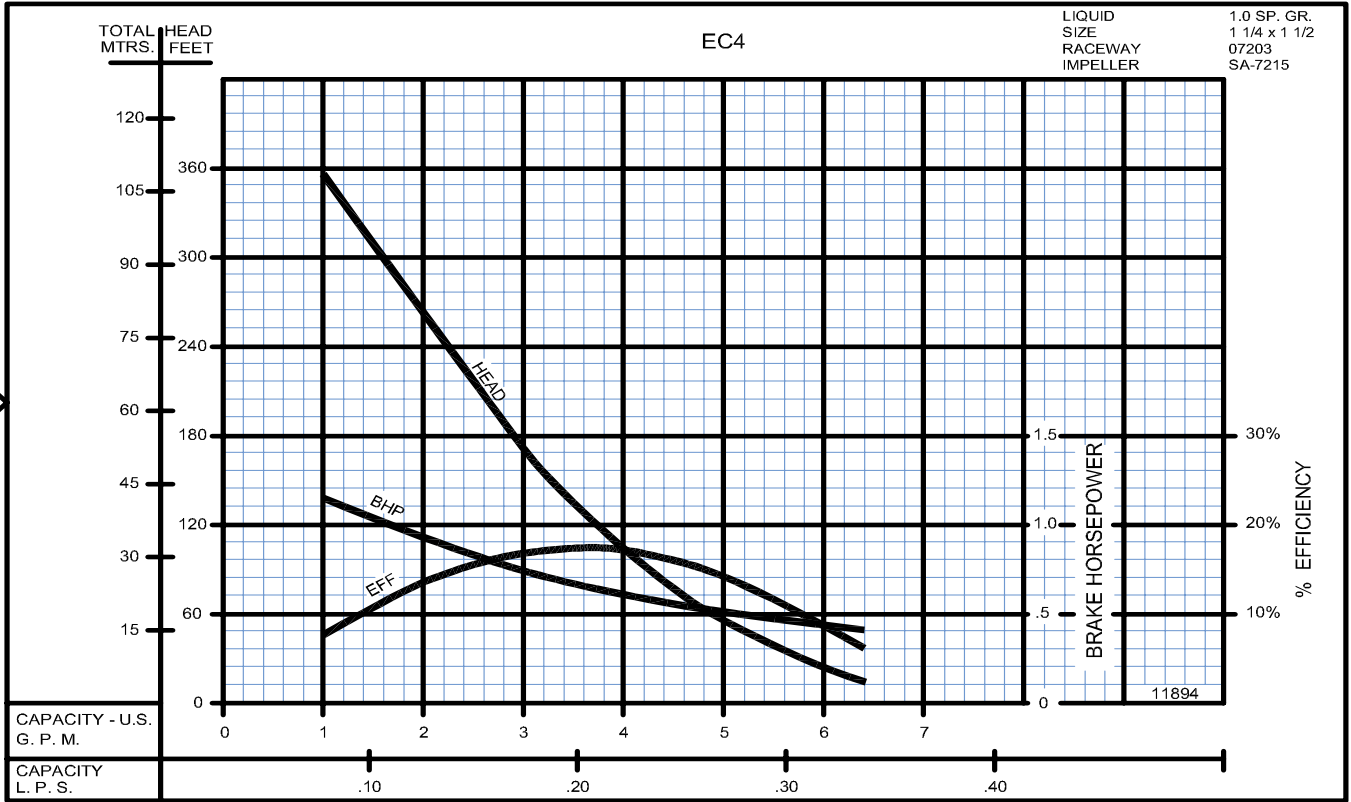

1450 RPM

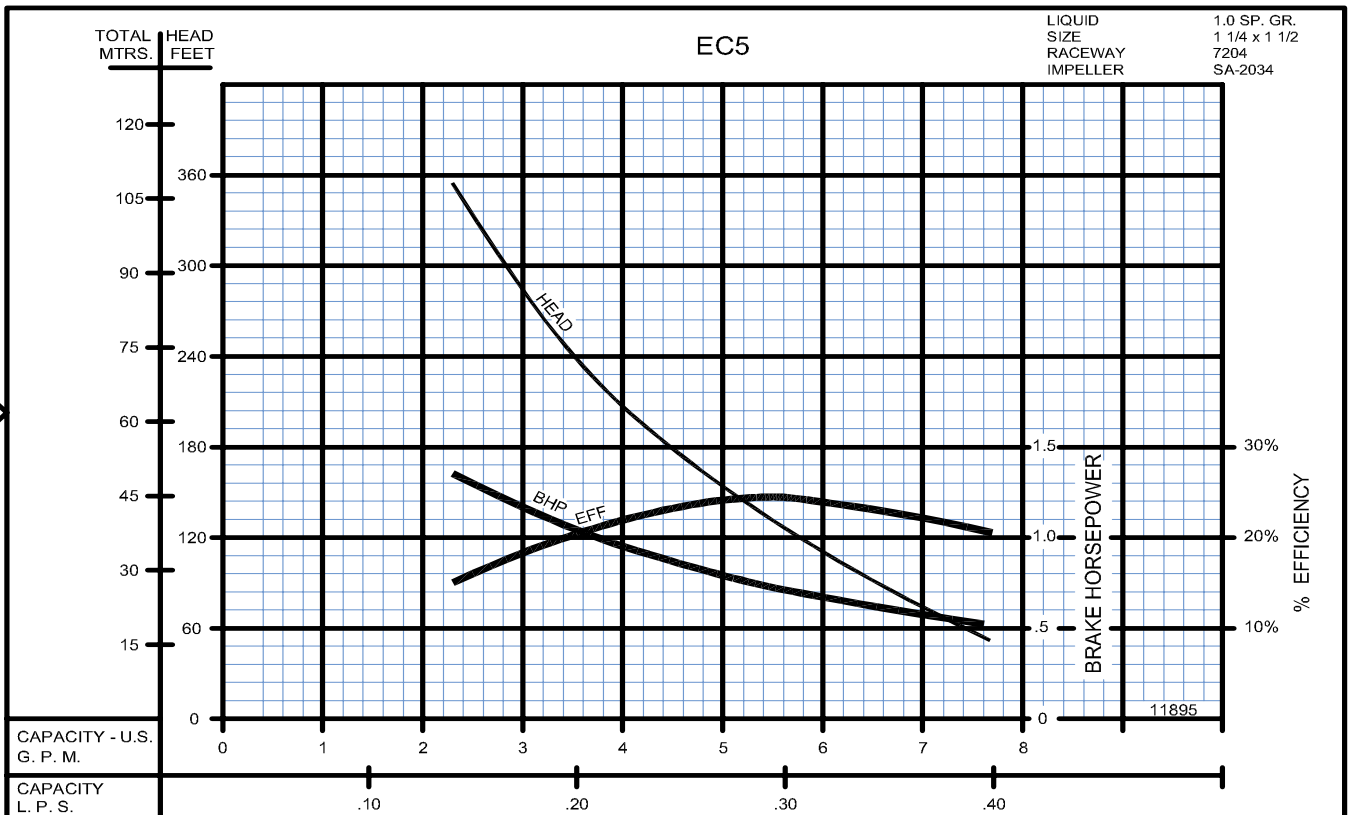

Base Mounted Turbine Pumps

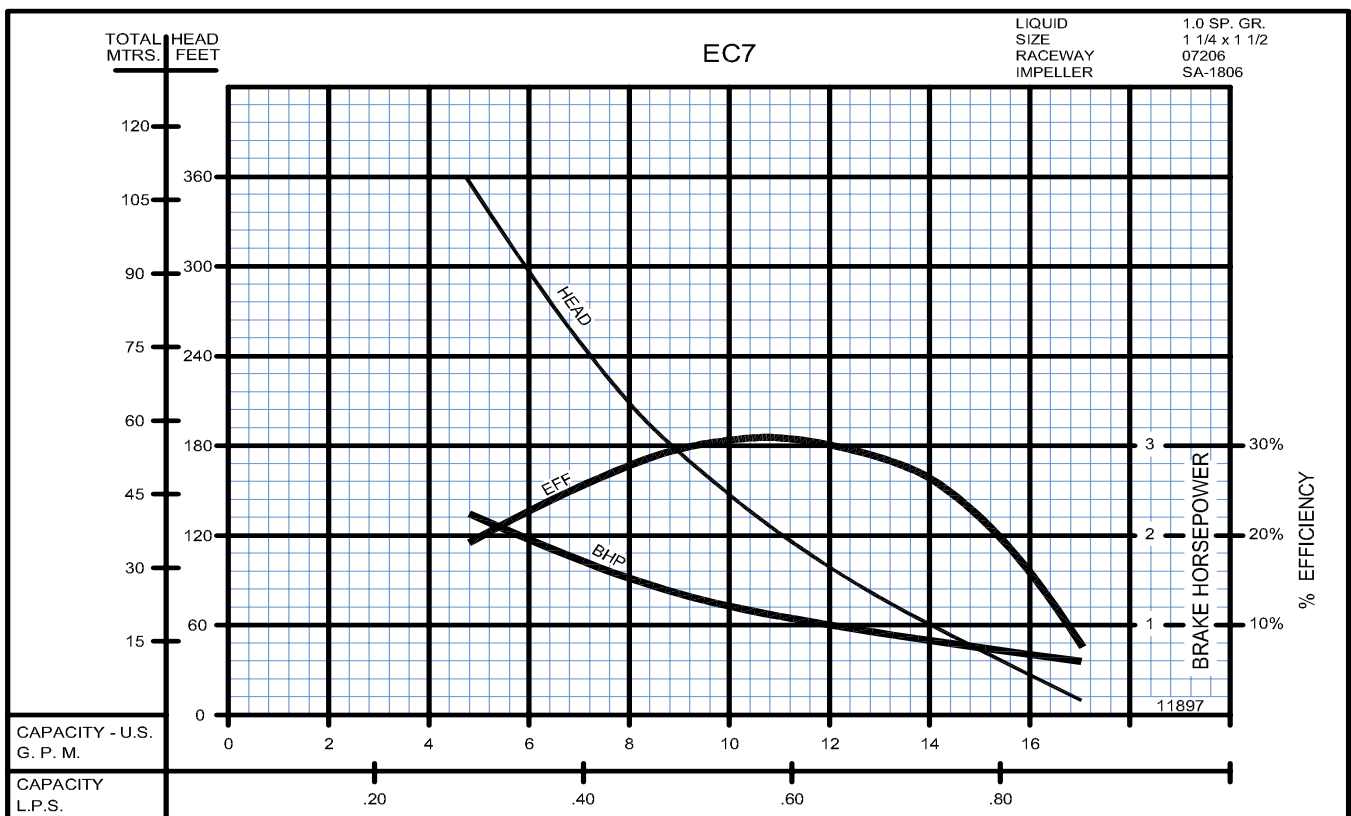
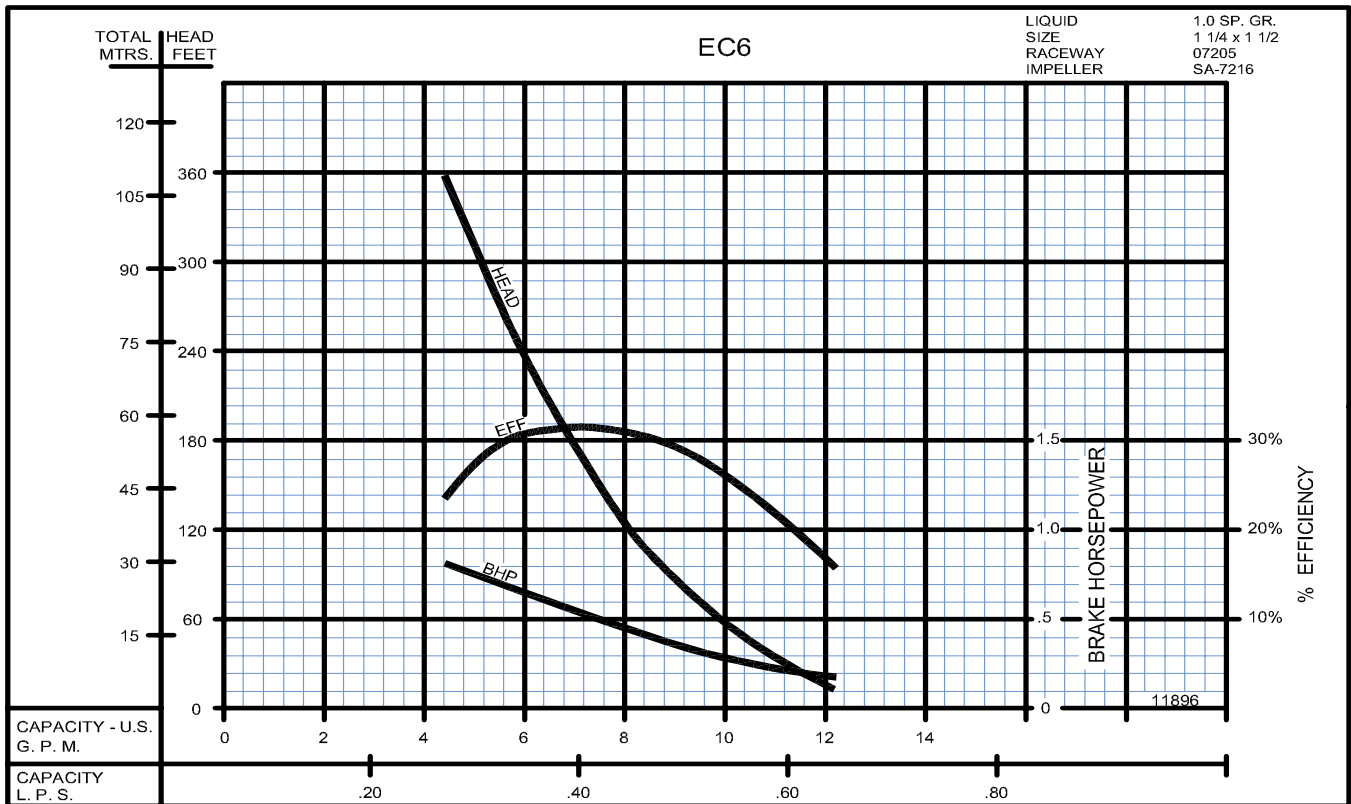

Base Mounted Turbine Pumps

1450 RPM

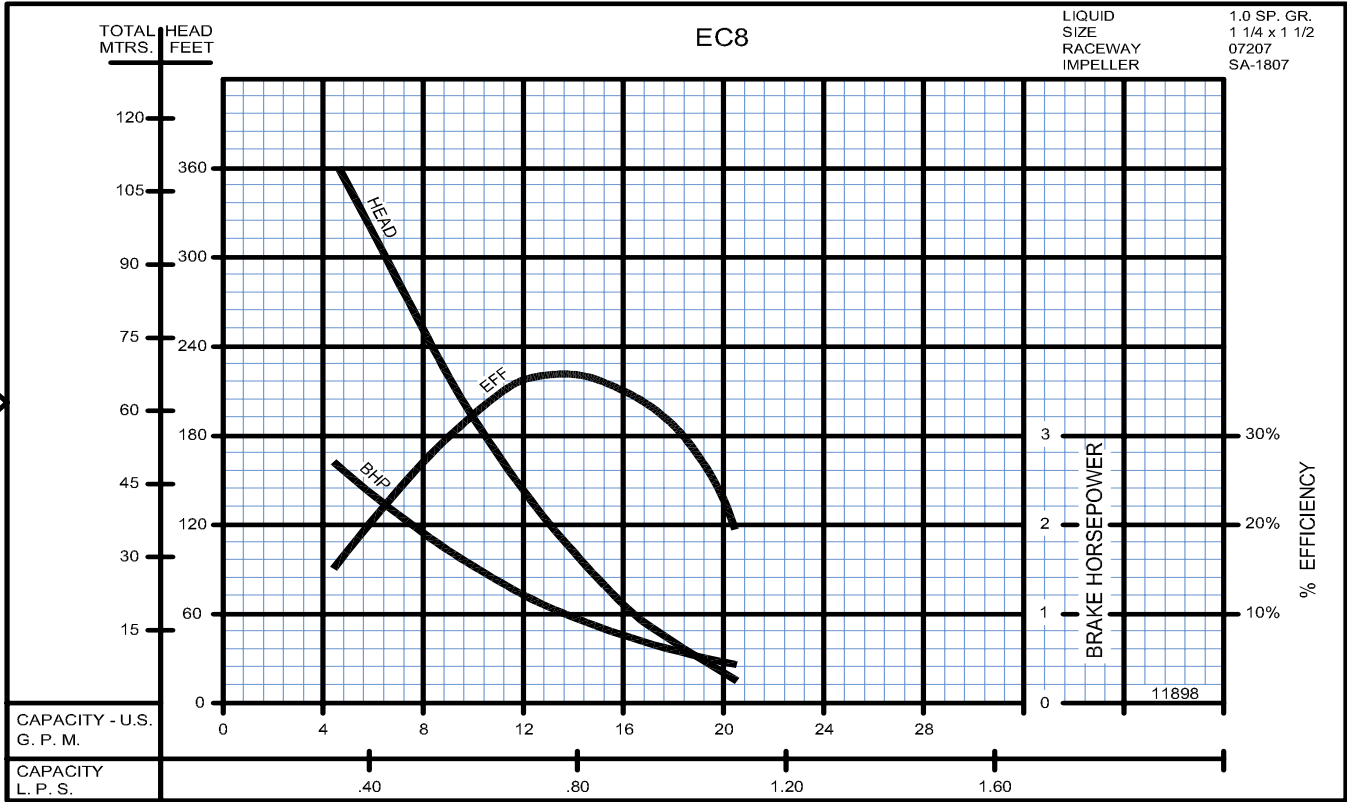

1450 RPM

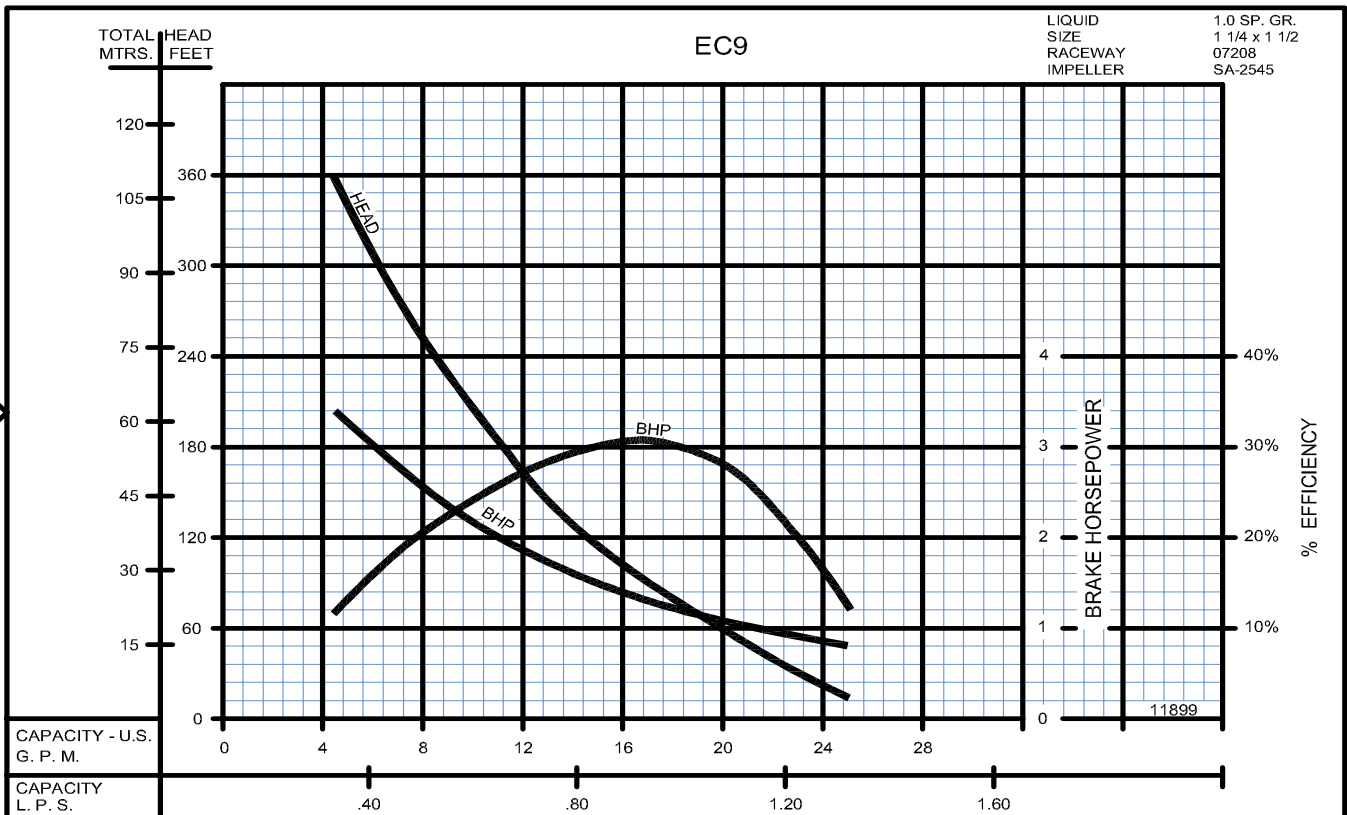

SECTION 6C
PAGE 14
DATE 1/06

CRANE[®]

PUMPS & SYSTEMS

A Crane Co. Company

USA: (937) 778-8947 • Canada: (905) 457-6223 • International: (937) 615-3598

Base Mounted Turbine Pumps

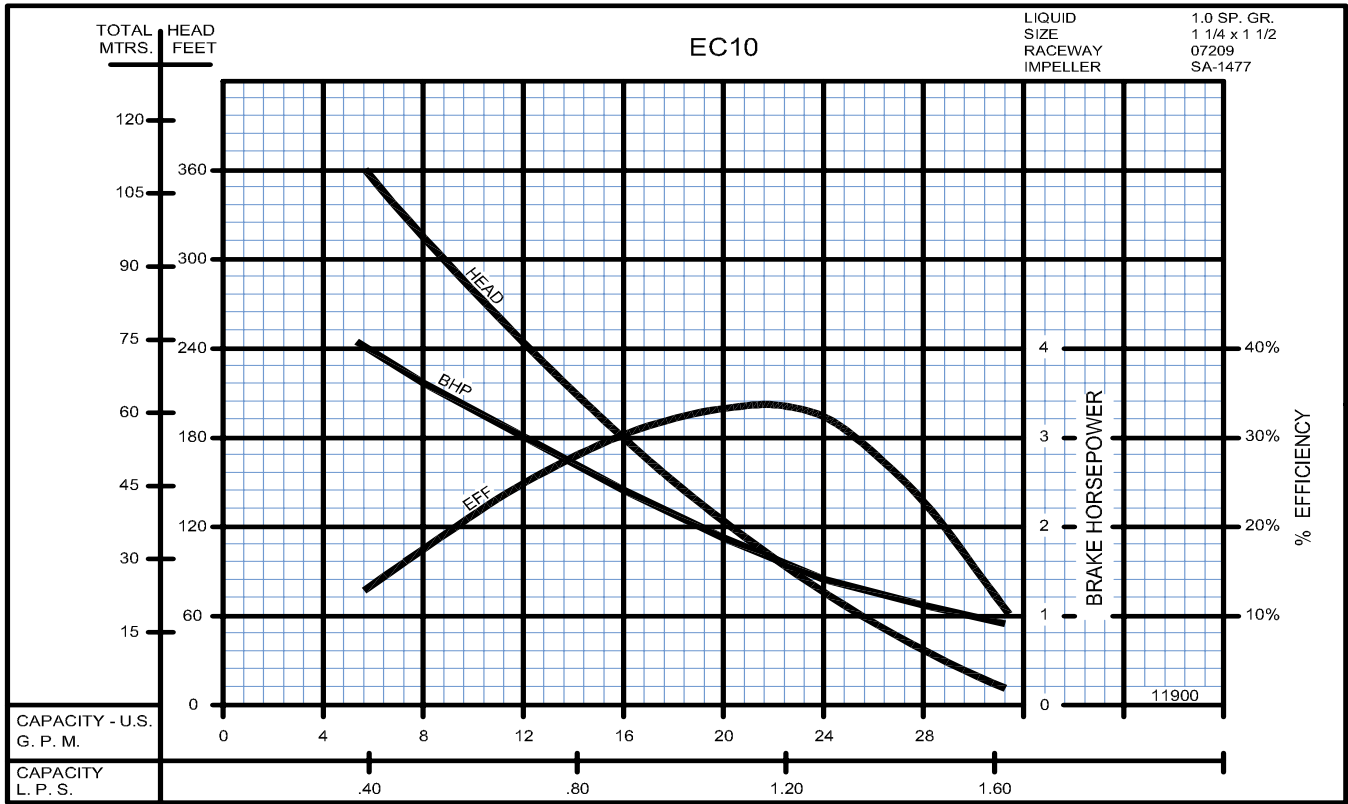

Base Mounted Turbine Pumps

1450
RPM

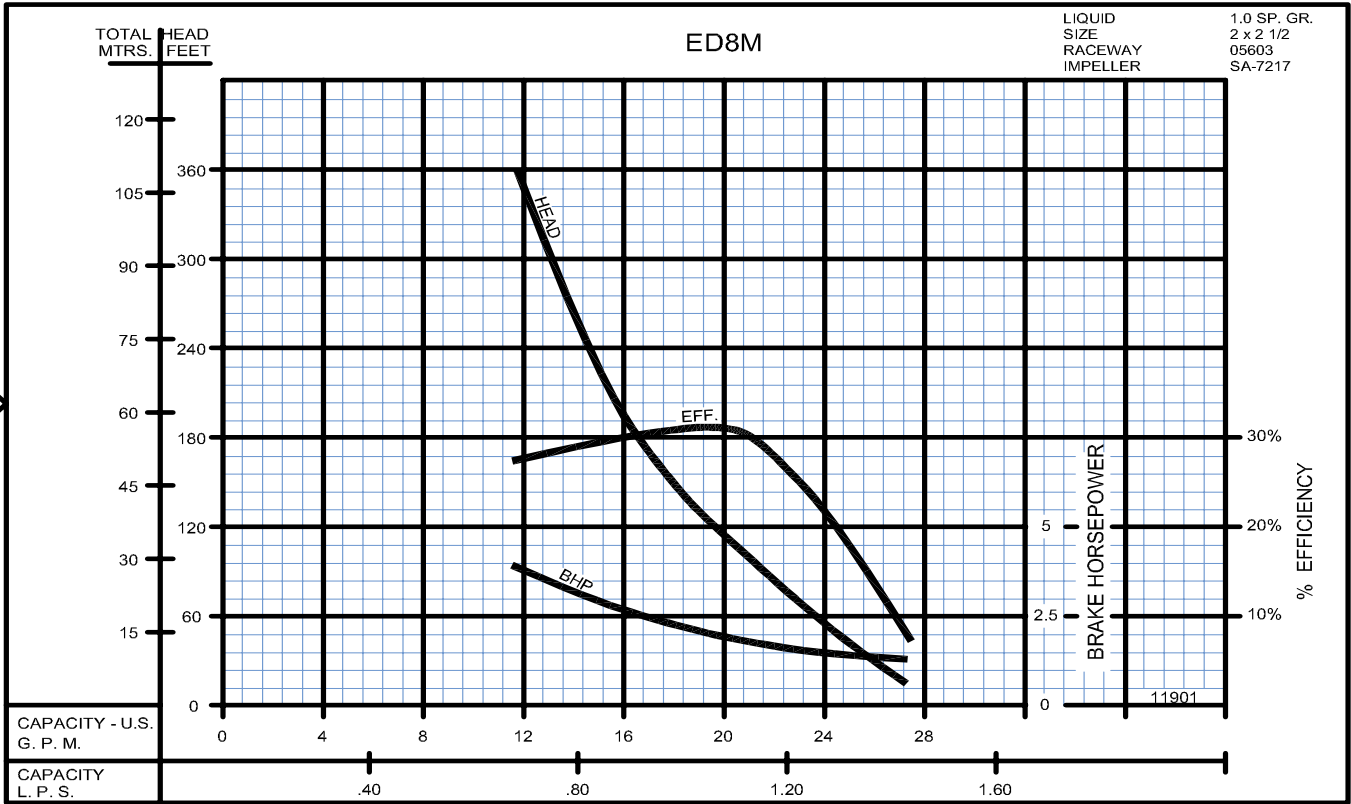

1450
RPM

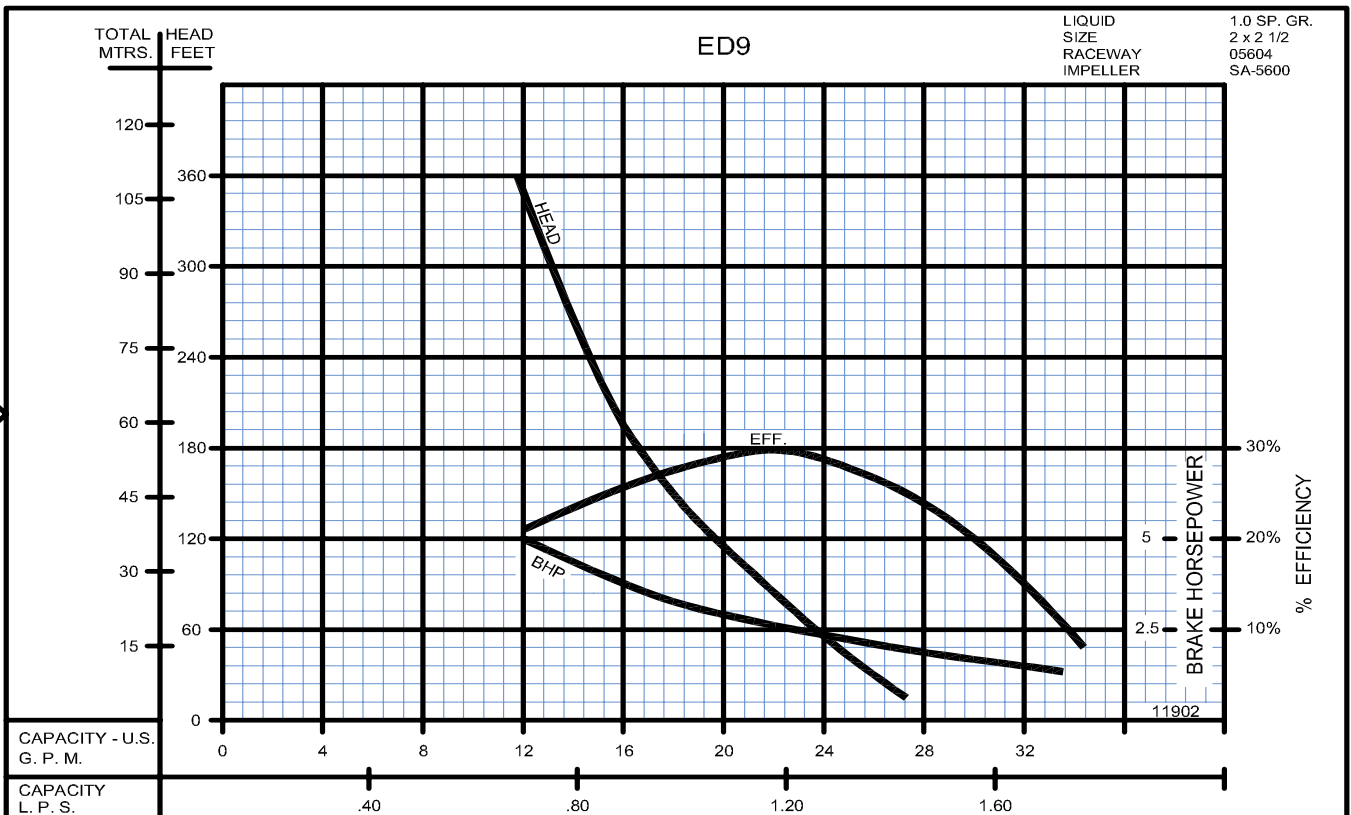

Base Mounted Turbine Pumps

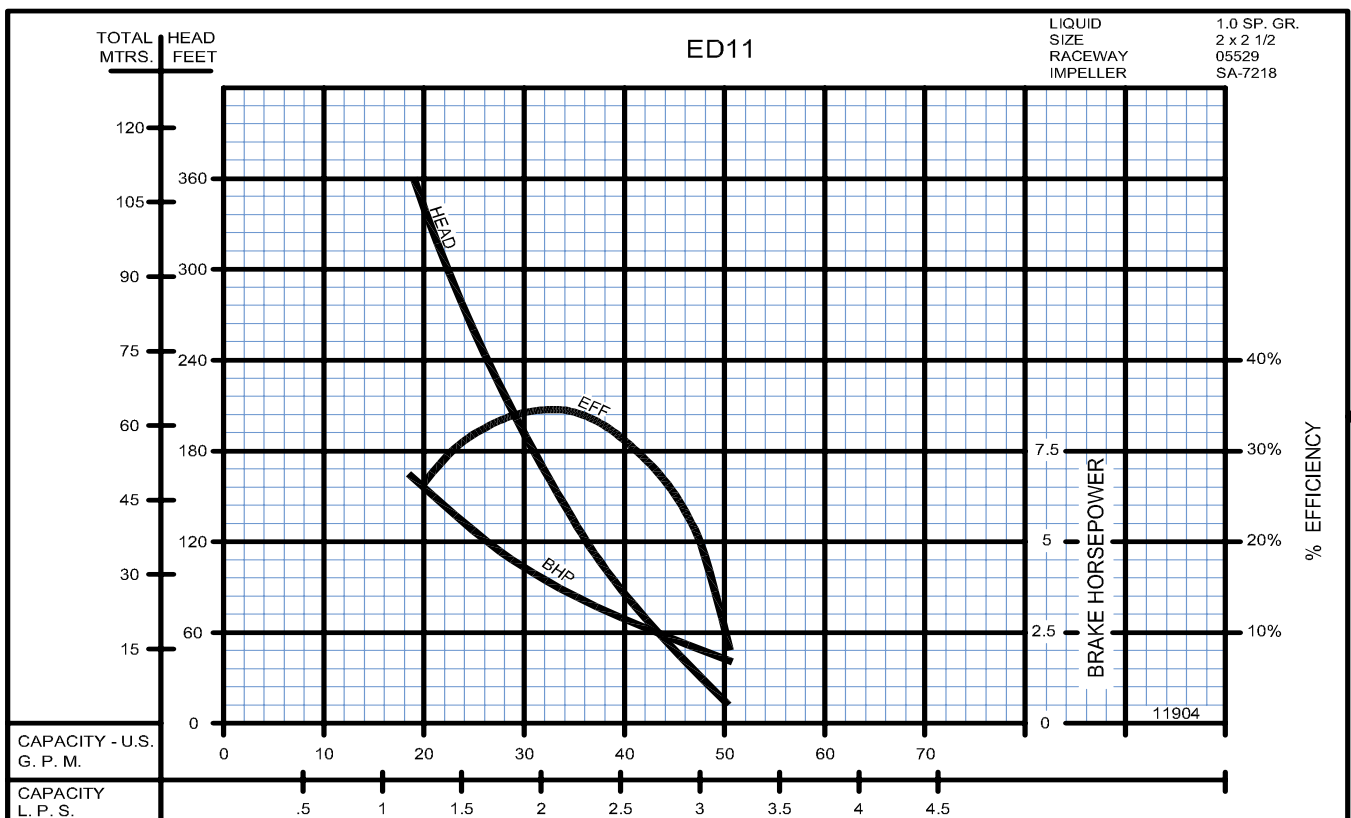
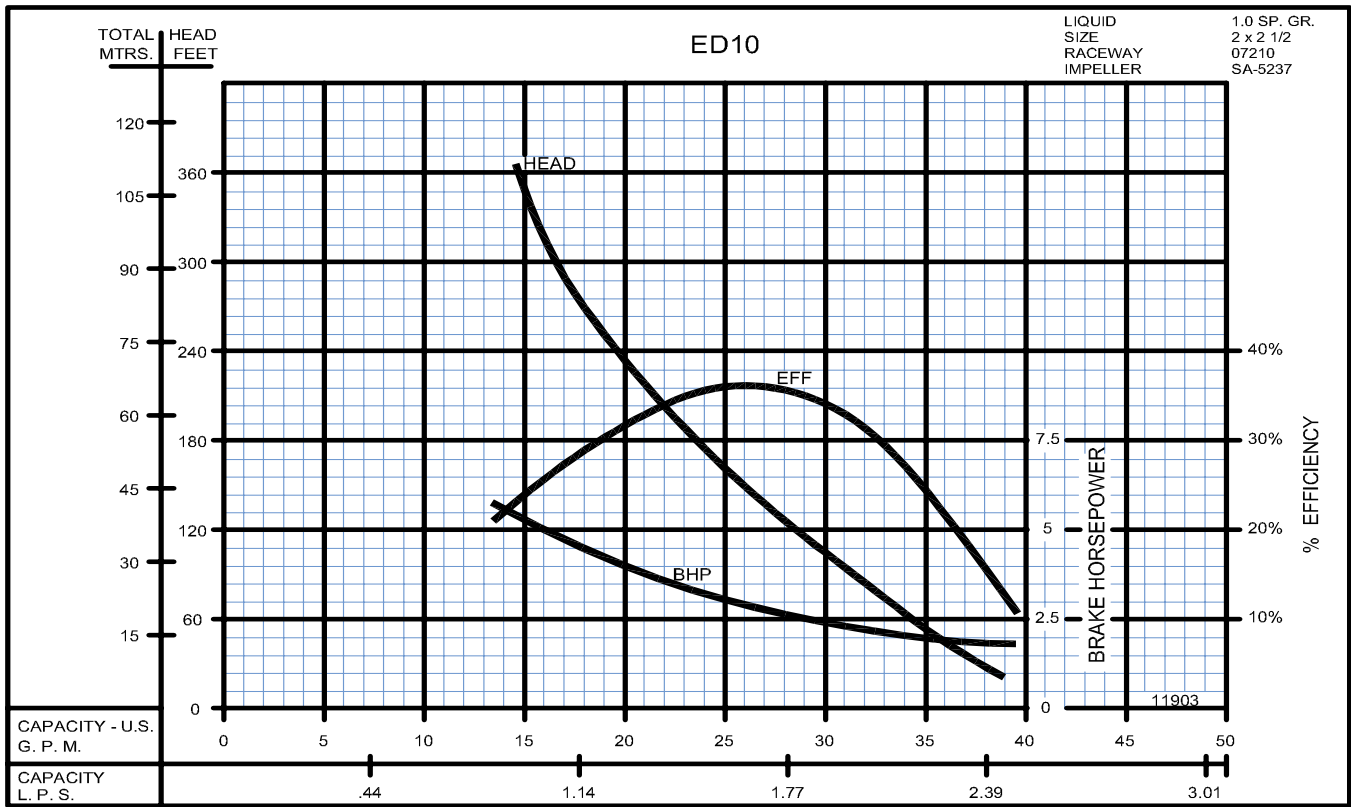

Base Mounted Turbine Pumps

1450 RPM

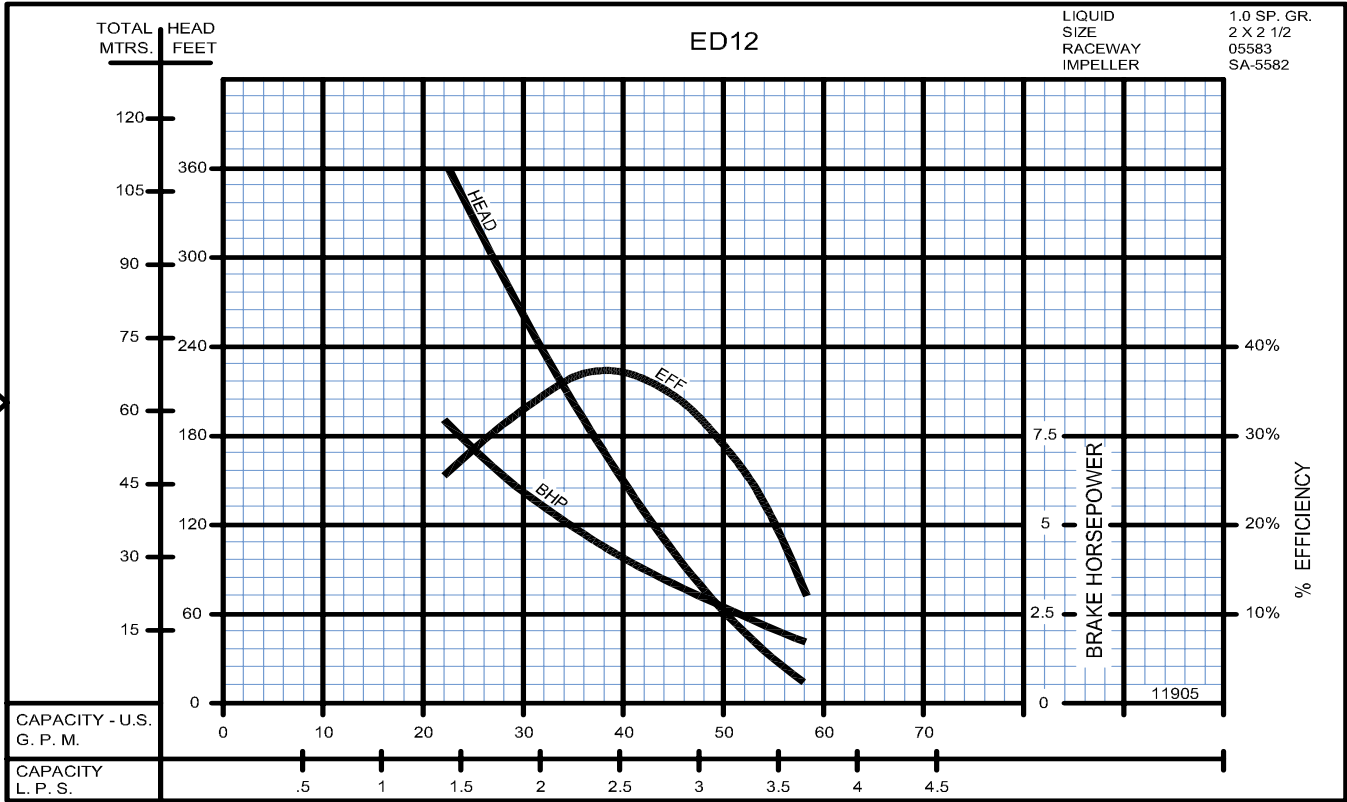

1450 RPM

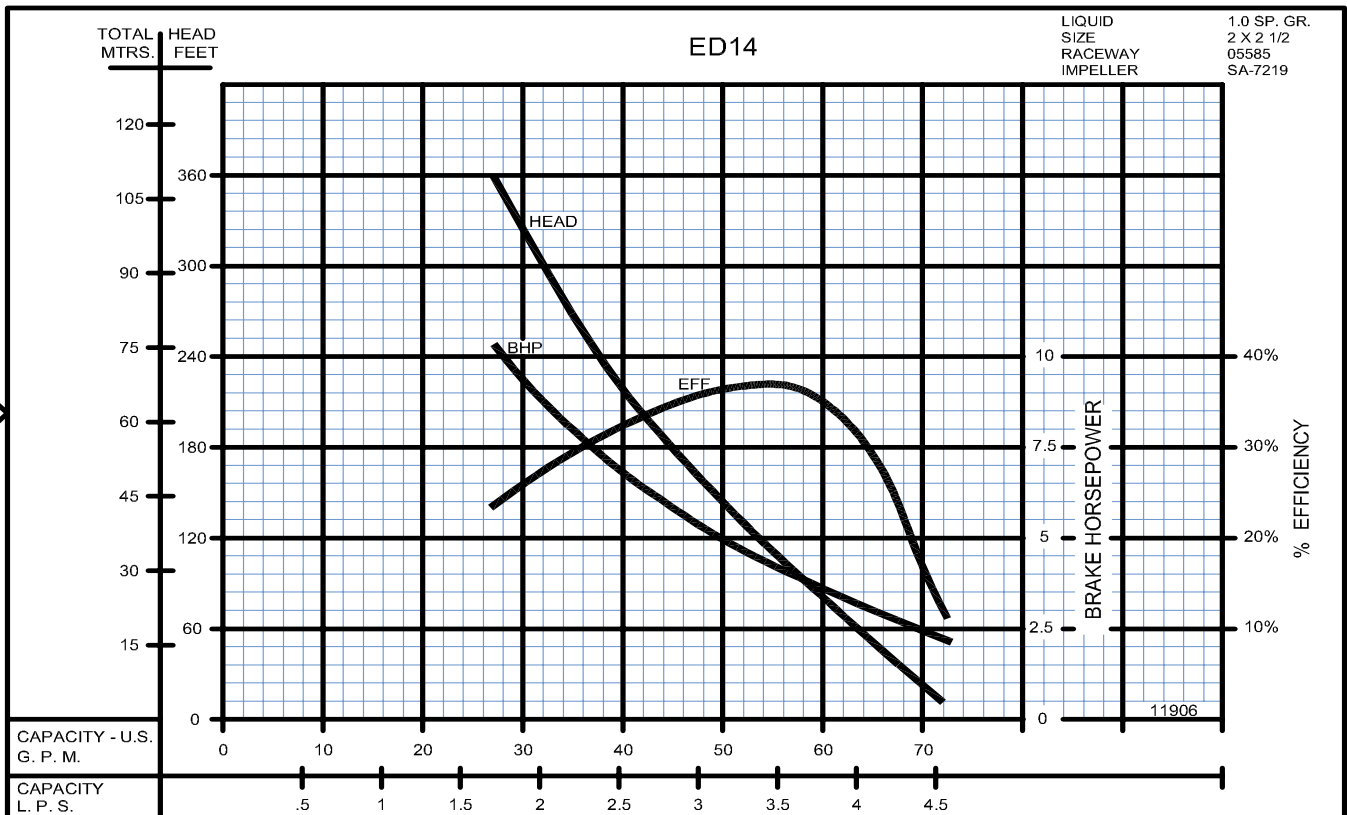

SECTION 6C
PAGE 18
DATE 1/06



PUMPS & SYSTEMS