

**Close Coupled End Suction**

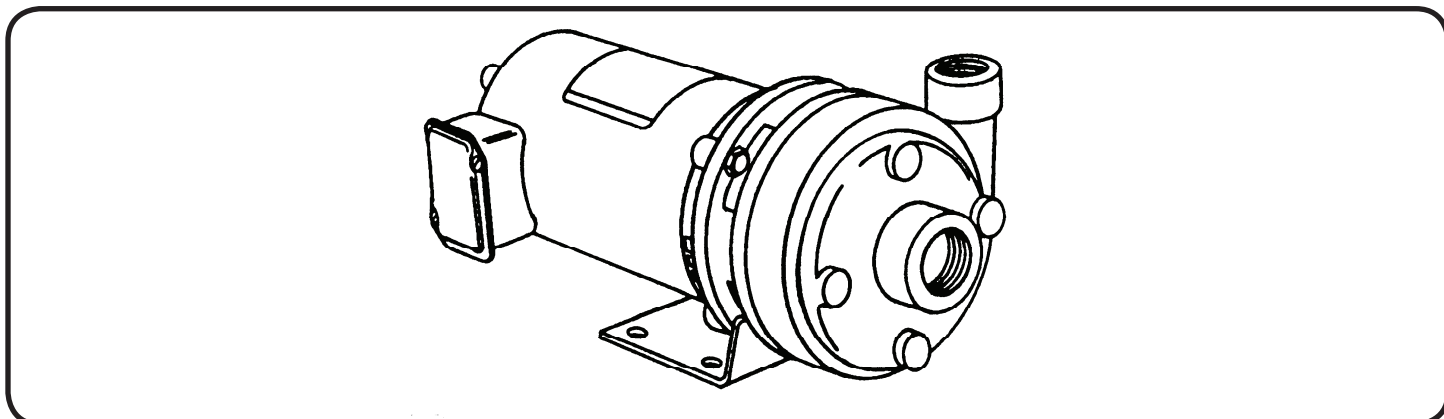

**3500 RPM - 60Hz.**  
 CAPACITIES TO 130 GPM (8.2 LPS)  
 HEADS TO 75 FEET (23 M)

(\* ) FOR CAPACITIES ABOVE 100 GPM  
 SEE GA4-1 1/2 CURVE.

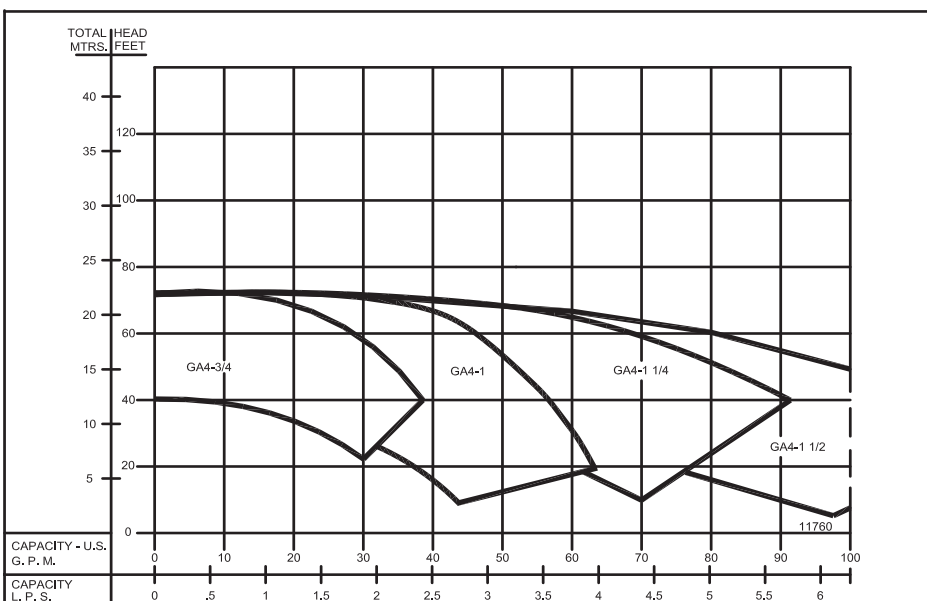

**2900 RPM - 50Hz.**  
 CAPACITIES TO 108 GPM (6.8 LPS)  
 HEADS TO 50 FEET (15 M)

Individual performance curve should be  
 checked for final selection.

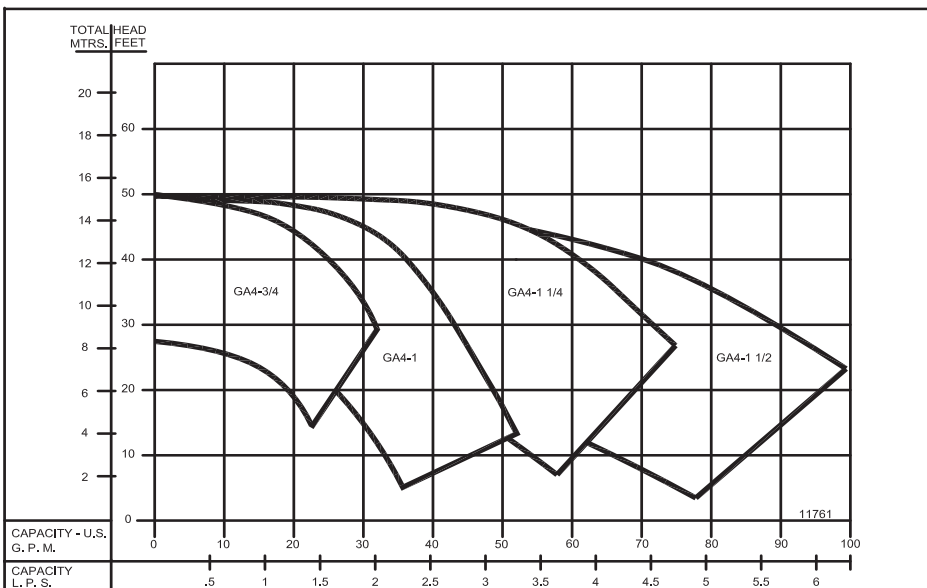

## Features

**Close Coupled End Suction****FOUR POSITION CASING**

Discharge can be located in any of four positions. Casing is close grain iron of 30,000 psi minimum tensile strength. Back pull-out design eliminates the need to disturb piping should the pump ever require service - the casing stays in the line.

**ENCLOSED CAST IRON IMPELLER**

Of the latest hydraulic design for maximum efficiency, impeller is balanced for vibration-free operation and threaded onto stainless steel motor shaft. Impeller is available in bronze.

**MECHANICAL SHAFT SEAL**

Standard self-adjusting shaft seal for temperatures to 225°F (107°C) and pressures to 150 psi (1034 kpa). Ceramic seat and carbon seal face for long trouble-free service. Special seals are available for higher temperatures and fluids other than water.

**MOTORS**

Standard pump motors are of open drip proof (ODP) construction and are rated with jet pump service factors for continuous duty operation. Motors are 56 frame size with NEMA standard mounting flange, one piece threaded stainless steel shaft and ball/ball bearing construction.

**FACTORY TESTED**

After careful assembly and inspection, EVERY pump is factory tested and meets Hydraulic Institute standards.

**MAXIMUM OPERATING CONDITIONS**

TEMPERATURE (For Standard Buna-N Seal)	225°F (107°C)
INLET PRESSURE	70 PSI (433kPa)
CASING WORKING PRESSURE	100 PSI (690kPa)

**MOTOR INFORMATION**

60 Hz - 3500 RPM - ODP

Single Phase: 1/3 thru 2 Hp. - 115/230 Volt  
3 Hp. - 230 Volt only

Three Phase: 1/3 thru 3 Hp. - 208-230/460 Volt

50 Hz - 2900 RPM - ODP

Single Phase: 110/220 Volt

Three Phase: 380 Volt

Voltages may differ from some suppliers. Consult factory.

Overload Protection: All single phase ODP and Totally Enclosed motors have built-in overload protection. All three phase motors and all explosion proof motors must be installed with a magnetic starter which provides full 3-leg protection. Failure to use correct starter and overloads will void motor warranty.

**MATERIALS OF CONSTRUCTION**

PART	ALL IRON	BRONZE FITTED	ALL BRONZE
Adapter	Cast Iron	Cast Iron	Bronze
Casing	Cast Iron	Cast Iron	Bronze
Impeller	Cast Iron	Bronze	Bronze
Shaft	#303 Stainless	#303 Stainless	#303 Stainless
Shaft Seal	Carbon-Ceramic SS - Buna-N	Carbon-Ceramic SS - Buna-N	Carbon-Ceramic SS - Buna-N

**WARNING:**

CANCER AND REPRODUCTIVE HARM -  
WWW.P65WARNINGS.CA.GOV

SECTION 2  
PAGE 2  
DATE 11/18

**CRANE**<sup>®</sup>

A Crane Co. Company

**PUMPS & SYSTEMS**

USA: (937) 778-8947 • Canada: (905) 457-6223 • International: (937) 615-3598

#### Close Coupled End Suction



DIMENSIONS IN INCHES																		
MODEL	MOTOR FRAME SIZE	DISC NPT (in)	SUCT. NPT (in)	A	B	CP	D	DD	E	F	G	L	O	OP	P	X	Y	Z
GA4-3/4	56	3/4	1	6	5	15 1/2	3 1/2	3 5/16	2 1/2	3	3/16	5 1/2	6 3/4	7	1 1/8	3 1/2	2 1/16	2 5/8
GA4-1	56	1	1 1/4	6	5	15 9/16	3 1/2	3 5/16	2 1/2	3	3/16	5 9/16	6 3/4	7	1 1/8	3 1/2	1 15/16	2 11/16
GA4-1 1/4	56	1 1/4	1 1/2	6	5	15 13/16	3 1/2	3 5/16	2 1/2	3	3/16	5 15/16	6 3/4	7 1/2	1 1/8	4	2 3/16	3
GA4-1 1/2	56	1 1/2	2	6	5	16 1/16	3 1/2	3 7/16	2 1/2	3	3/16	6 1/16	6 3/4	8	1 1/8	4 1/2	2 5/16	3 1/8

DIMENSIONS IN MILLIMETERS																		
MODEL	MOTOR FRAME SIZE	DISC NPT (in)	SUCT. NPT (in)	A	B	CP	D	DD	E	F	G	L	O	OP	P	X	Y	Z
GA4-3/4	56	3/4	1	152	127	394	89	84	64	76	4.8	140	172	178	29	89	52	67
GA4-1	56	1	1 1/4	152	127	395	89	84	64	76	4.8	141	172	178	29	89	49	68
GA4-1 1/4	56	1 1/4	1 1/2	152	127	402	89	84	64	76	4.8	151	172	191	29	102	55	76
GA4-1 1/2	56	1 1/2	2	152	127	408	89	87	64	76	4.8	154	172	203	29	114	59	79

DIMENSIONS SHOWN ABOVE ARE APPROXIMATE MAXIMUM DIMENSIONS FOR STANDARD PUMPS EQUIPPED WITH ODP MOTORS.

### Close Coupled End Suction

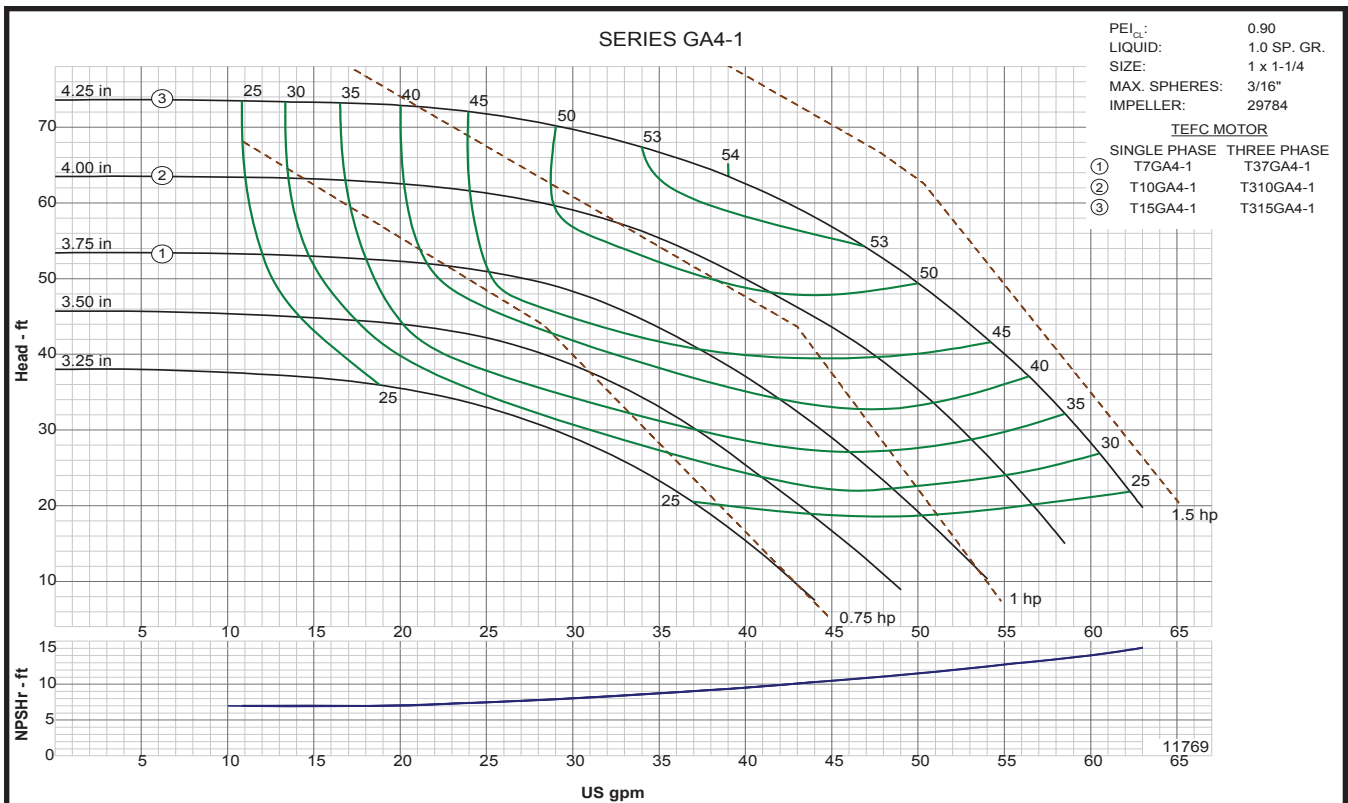
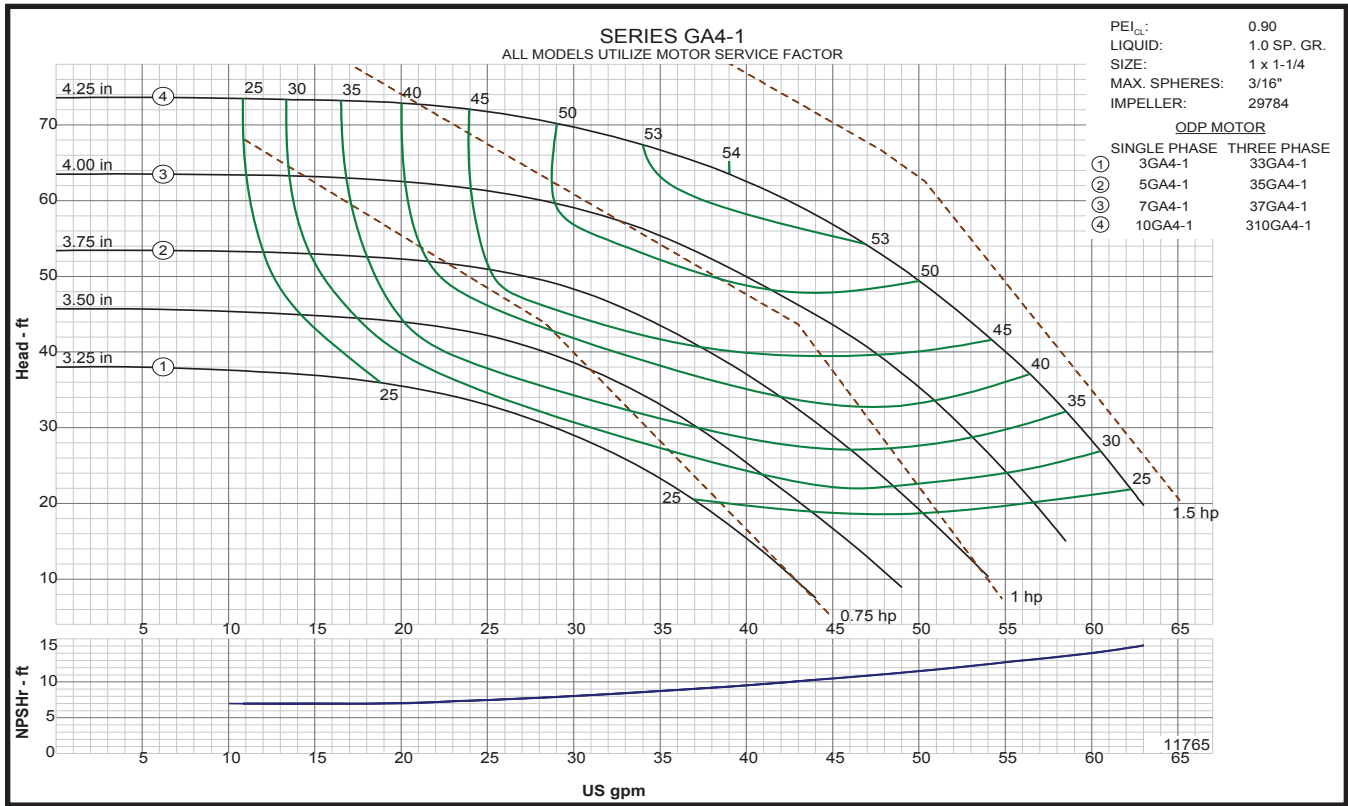

**Close Coupled End Suction**

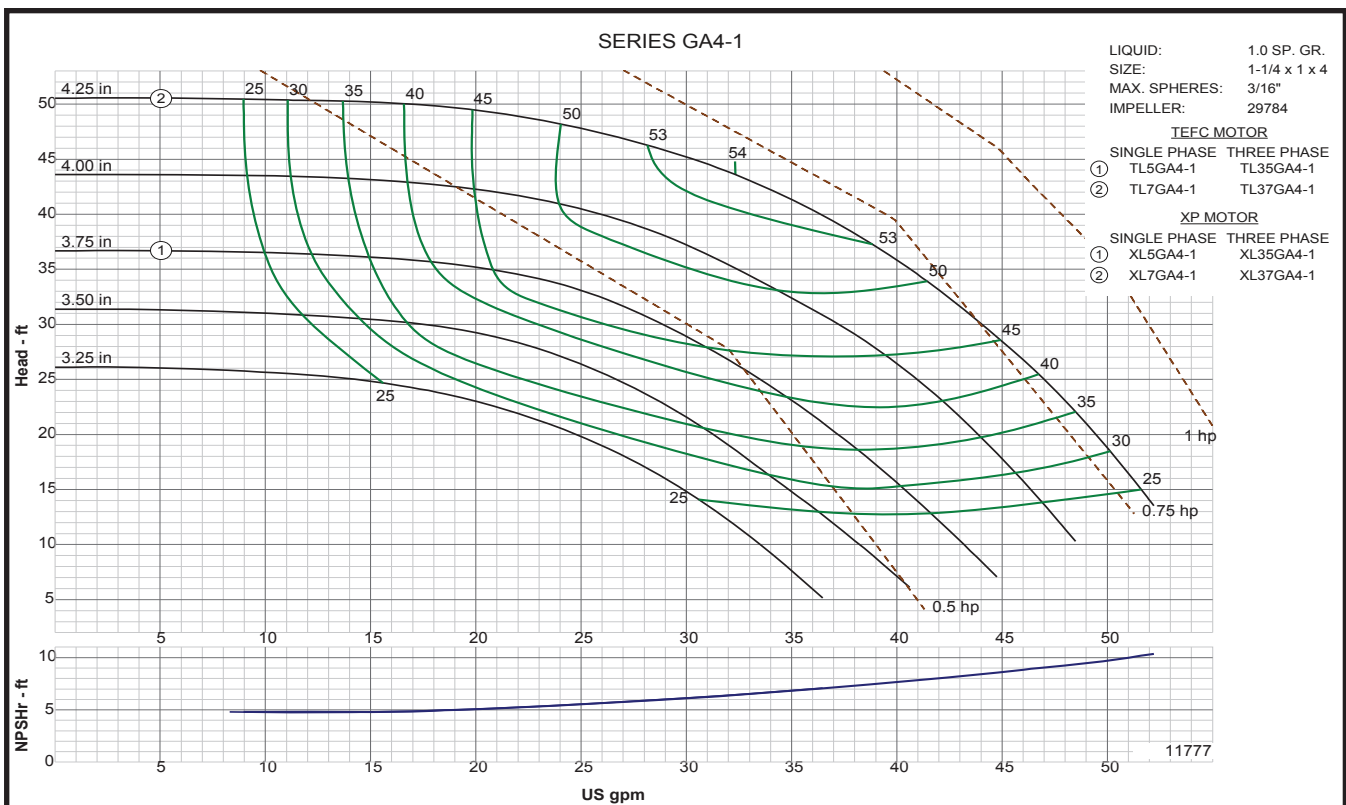
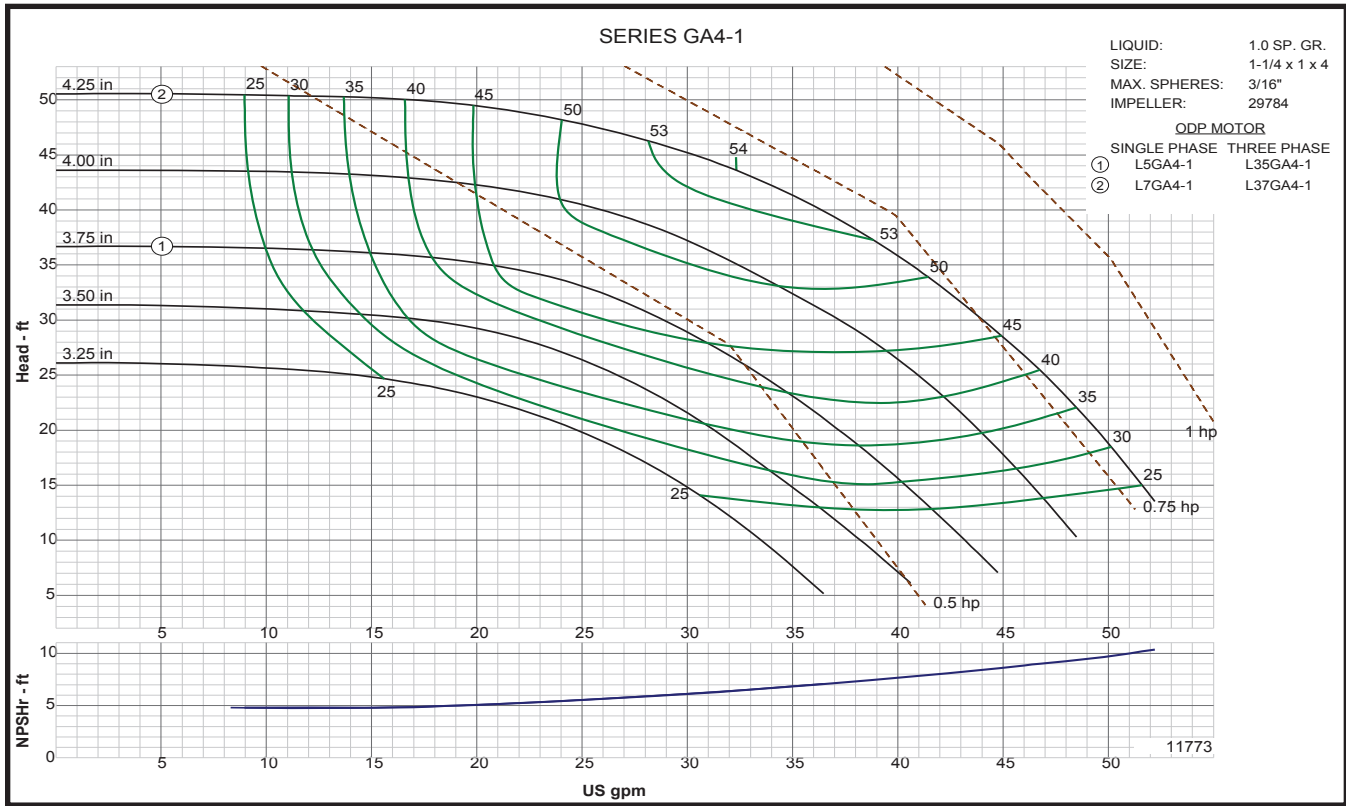

*Centrifugals - Close Coupled*



1 - MOTORS (All 56J Frame)		
RPM & PHASE	PART NUMBER	HP
<b>OPEN DRIP PROOF</b>		
3500 RPM Single Phase (ODP)	003-211-371-02	1/3
	005-211-371-02	1/2
	007-211-371-02	3/4
	010-211-371-02	1
	015-211-371-02	1½
020-211-371-02	2	
3500 RPM Three Phase (ODP)	003-230-361-02	1/3
	005-230-361-02	1/2
	007-230-361-02	3/4
	010-230-361-02	1
	015-230-361-02	1½
020-230-361-02	2	
<b>TOTALLY ENCLOSED</b>		
3500 RPM Single Phase (TENV / TEFC)	005-211-372-02	1/2
	007-211-372-02	3/4
	010-211-372-02	1
	015-211-372-02	1½
	020-211-372-02	2
3500 RPM Three Phase (TENV / TEFC)	005-230-362-02	1/2
	007-230-362-02	3/4
	010-230-362D02	1
	015-230-362D02	1½
	020-230-362D02	2
<b>EXPLOSION PROOF</b>		
3500 RPM Single Phase (XP)	005-211-374-02	1/2
	007-211-374-02	3/4
	010-211-374-02	1
	015-211-374-02	1½
	020-211-374-02	2
3500 RPM Three Phase (XP)	005-230-364-02	1/2
	007-230-364-02	3/4
	010-230-364-02	1
	015-230-364-02	1½
	020-230-364-02	2

SYMBOL NUMBER	PART NUMBER	QTY	DESCRIPTION
9	08514	1	Mechanical Seal
10	00158	1	Pipe Plug 1/8"
11	0115519	1	Base
12	20459	1	Nut
13	0115516	1	Case Gasket

SYMBOL NUMBER	PART NUMBER	QTY	DESCRIPTION
2	08105	1	Slinger Washer
3	0115478	1	Adapter
4	03122	4	Cap Screw, 3/8-16 x 3/4" Lg
5	Q15-5-E26	4	Cap Screw, 3/8-16 x 7/8" Lg
6	00158	4	Pipe Plug 1/8"
7	0115488	1	Casing, GA4-3/4
	0115490	1	Casing, GA4-1
	0115492	1	Casing, GA4-1-1/4
	0115494	1	Casing, GA4-1-1/2
8	0115432-3.75	1	Impeller, Brass, 3GA4 & 33GA4-3/4
	0115432-4.00	1	Impeller, Brass, 5GA4 & 35GA4-3/4
	0115432-4.25	1	Impeller, Brass, 7GA4 & 37GA4-3/4
	0115436-3.25	1	Impeller, Brass, 3GA4 & 33GA4-1
	0115436-3.75	1	Impeller, Brass, 5GA4 & 35GA4-1
	0115436-4.00	1	Impeller, Brass, 7GA4 & 37GA4-1
	0115436-4.25	1	Impeller, Brass, 10GA4 & 310GA4-1
	0115440-3.25	1	Impeller, Brass, 3GA4 & 33GA4-1-1/4
	0115440-3.50	1	Impeller, Brass, 5GA4 & 35GA4-1-1/4
	0115440-3.75	1	Impeller, Brass, 7GA4 & 37GA4-1-1/4
	0115440-4.00	1	Impeller, Brass, 10GA4 & 310GA4-1-1/4
	0115440-4.25	1	Impeller, Brass, 15GA4 & 315GA4-1-1/4
	0115444-3.25	1	Impeller, Brass, 5GA4 & 35GA4-1-1/2
	0115444-3.50	1	Impeller, Brass, 7GA4 & 37GA4-1-1/2
	0115444-3.75	1	Impeller, Brass, 10GA4 & 310GA4-1-1/2
	0115444-4.25	1	Impeller, Brass, 15GA4 & 315GA4-1-1/2

**CRANE**

A Crane Co. Company

**PUMPS & SYSTEMS**

USA: (937) 778-8947 • Canada: (905) 457-6223 • International: (937) 615-3598

SECTION CCCP  
PAGE 3  
DATE 11/18



**WARNING:**  
CANCER AND REPRODUCTIVE HARM -  
WWW.P65WARNINGS.CA.GOV