

**Close Coupled Self Priming Pumps**

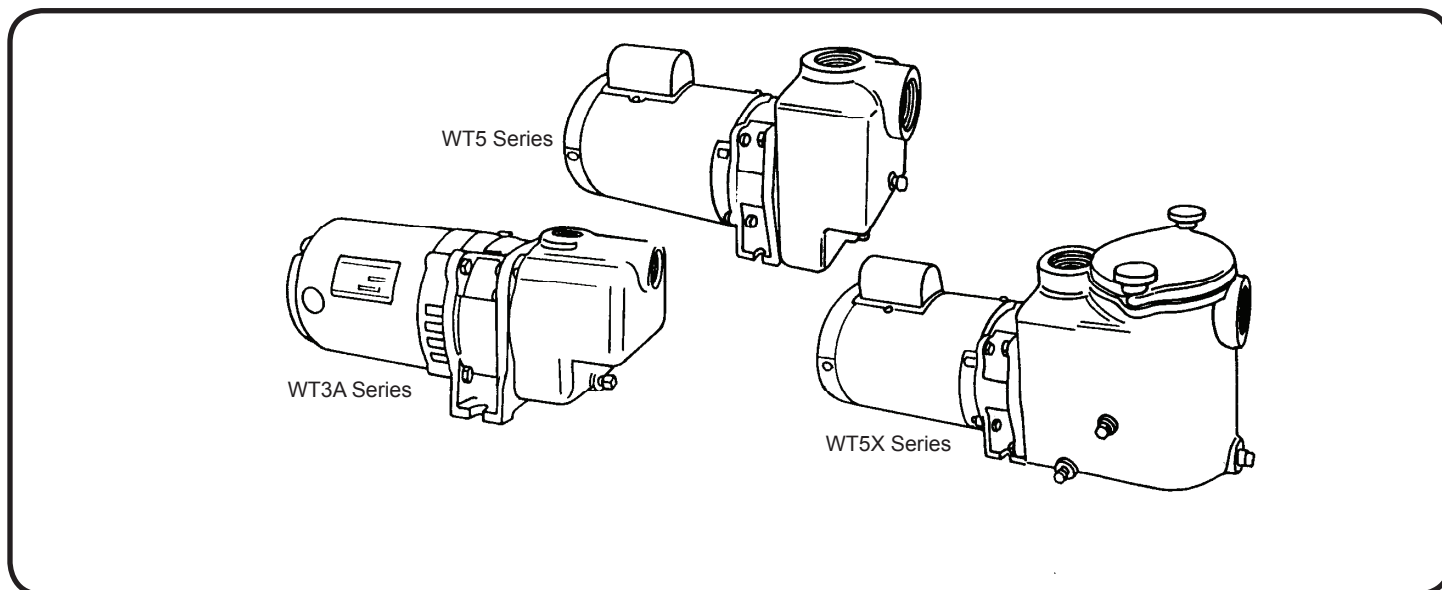

60 Hz - PERFORMANCE AND SELECTION 1.00 S.G. FLUIDS												
Catalog No.*		HP	Tappings		Capacity in GPM (LPS) - Total Head Feet (Meters)							
1 Phase	3 Phase		Suct.	Disch.	10' (3m)	15' (4.5m)	20' (6m)	25' (7.6m)	30' (9m)	35' (10.6m)	38' (11.5m)	
A3WT3A	33WT3A	1/3	1"	1"	42 (2.6)	40 (2.5)	37 (2.3)	33 (2.0)	26 (1.6)	17 (1.0)	9 (0.5)	

Catalog No.**	Catalog No. w/ Strainer**	HP	Tappings		Capacity in GPM (LPS) - Total Head Feet (Meters)								
			Suct.	Disch.	10' (3m)	20' (6m)	30' (9m)	40' (12m)	50' (15m)	60' (18m)	70' (21m)	80' (24m)	90' (27m)
5WT5	5WT5X	1/2	2"	2"	55 (3.4)	49 (3.0)	43 (2.7)	37 (2.3)	30 (1.8)	21 (1.3)	10 (0.6)	---	---
7WT5	7WT5X	3/4			72 (4.5)	70 (4.4)	66 (4.1)	61 (3.8)	52 (3.2)	40 (2.5)	24 (1.5)	---	---
10WT5	10WT5X	1			81 (5.1)	79 (4.9)	76 (4.7)	72 (4.5)	65 (4.1)	54 (3.4)	40 (2.5)	20 (1.2)	---
15WT5	15WT5X	1½			86 (5.4)	86 (5.4)	84 (5.2)	80 (5.0)	75 (4.7)	67 (4.2)	54 (3.4)	38 (2.3)	18 (1.1)
20WT5	20WT5X	2			94 (5.9)	93 (5.8)	92 (5.8)	89 (5.6)	85 (5.3)	78 (4.9)	67 (4.2)	50 (3.1)	30 (1.8)
20WT5A	20WT5AX	2			140 (8.8)	140 (8.8)	132 (8.3)	119 (7.5)	99 (6.2)	---	---	---	---

(\*\*) Catalog numbers are for units with single phase motors. For three phase, add prefix, "3". Example: 35WT5X.

(\*) Maximum suction lift on WT3A - 7ft.  
Maximum suction lift on WT5 series - 20ft.

For Water and Other 1.00 S.G. Fluids

3500 RPM - 60 Hz.

**Close Coupled Self Priming Pumps**

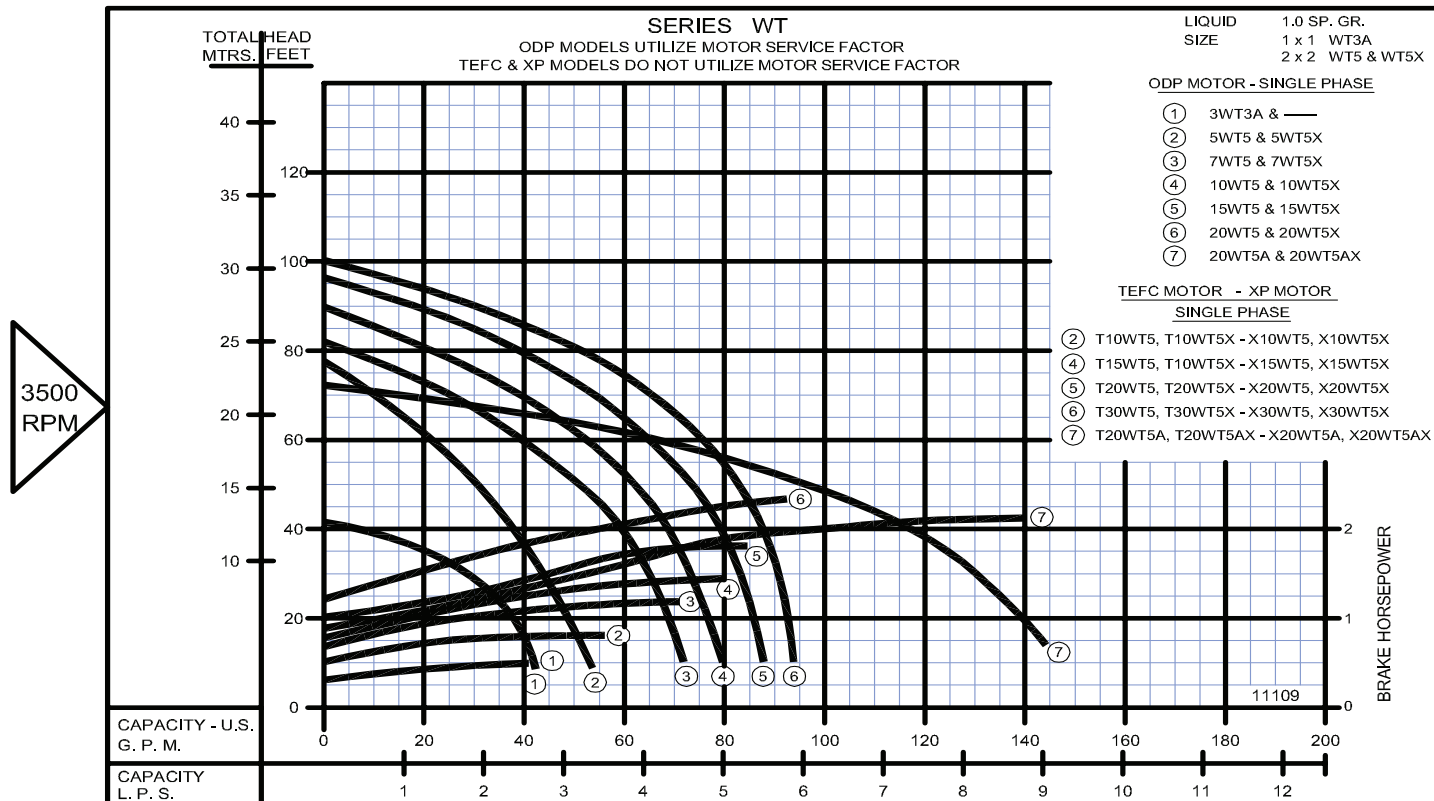

- Compact, Close-Coupled Design
- Rugged Bronze-Fitted Cast Iron Construction
- Leakproof Mechanical Shaft Seal
- Non-Clogging, Bronze Semi-Open Impeller
- Stainless Steel Shaft
- Back Pull-Out Design For Easy Servicing
- Available With or Without Built-In Basket Type Strainer
- Self-Priming, Once Case is Filled With Fluid
- Diaphragms, Flappers or Check Valves Are Not Required In Pump Suction Piping. But Are Recommended
- EVERY pump is factory tested and will meet Hydraulic Institute standards.

**MOTOR INFORMATION**

WT3A Series have NEMA Jet Pump Motors. WT5 & WT5X Series have rugged Swimming Pool type motors with oversize ball/ball bearing construction. All motors have open-drip proof construction and are rated with standard NEMA Jet Pump service factors for continuous duty operation at all ratings shown. Voltages may differ from some suppliers. Consult factory. Overload Protection: All single phase motors have built-in overload protection. All three phase motors must be installed with a magnetic starter which provides full 3-leg protection. Failure to use correct starter and overloads will void motor warranty. All Single Phase Open Drip Proof Motors Are U.L. Recognized.

**RATINGS**

A3WT3A-1/3 HP, Single Phase, 115V, 60Hz, 3500RPM, ODP, Split Phase.  
 3WT3A-1/3 HP, Single Phase, 115/230V, 60Hz, 3500RPM, ODP, Capacitor Start.  
 33WT3A-1/3 HP, Three Phase, 230/460V, 60Hz, 3500RPM, ODP  
 WT5 & WT5X Series: Single Phase: 1/2 thru 2HP, 115/230V, 60HZ, 3500RPM, ODP, Capacitor Start.  
 Three Phase: 1/2 thru 2HP, 230/460V, 60HZ, 3500RPM, ODP.

**MAXIMUM OPERATING CONDITIONS**

TEMPERATURE (For Standard Buna-N Seal)	225°F (107°C)
INLET PRESSURE (WT3 & WT5)	100 PSI (689kPa)
INLET PRESSURE (WT5X)	15 PSI (103kPa)
CASING WORKING PRESSURE (WT3 & WT5)	165 PSI (1137kPa)
CASING WORKING PRESSURE (WT5X)	60 PSI (413kPa)

**MATERIALS OF CONSTRUCTION**

PART	CAST IRON	BRONZE FITTED
Adapter	Cast Iron	Cast Iron
Case	Cast Iron	Cast Iron
Diffuser	Cast Iron	Cast Iron
Impeller	Cast Iron	Bronze
Shaft	Stainless	Stainless
Shaft Seal	Carbon-Ceramic SS - Buna-N	
Suction Sleeve	Buna-N	Buna-N
Strainer Gasket	Buna-N	Buna-N
Strainer Basket	Stainless	Stainless
All Plugs	Brass	Stainless



**WARNING:**  
 CANCER AND REPRODUCTIVE HARM -  
 WWW.P65WARNINGS.CA.GOV

### Close Coupled Self Priming Pumps

#### SERIES: WT3A



DIMENSIONS IN INCHES				
CATALOG NUMBER	SINGLE PHASE		THREE PHASE	
	A	B	A	B
A3WT3A	15	7 <sup>5</sup> / <sub>8</sub>	---	---
3WT3A	15 <sup>1</sup> / <sub>2</sub>	8 <sup>3</sup> / <sub>8</sub>	---	---
33WT3A	---	---	15 <sup>1</sup> / <sub>2</sub>	8 <sup>3</sup> / <sub>8</sub>

DIMENSIONS IN MILLIMETERS				
CATALOG NUMBER	SINGLE PHASE		THREE PHASE	
	A	B	A	B
A3WT3A	381	200	---	---
3WT3A	393	212	---	---
33WT3A	---	---	393	212

All models have 1" NPT suction and discharge.

#### SERIES: WT5

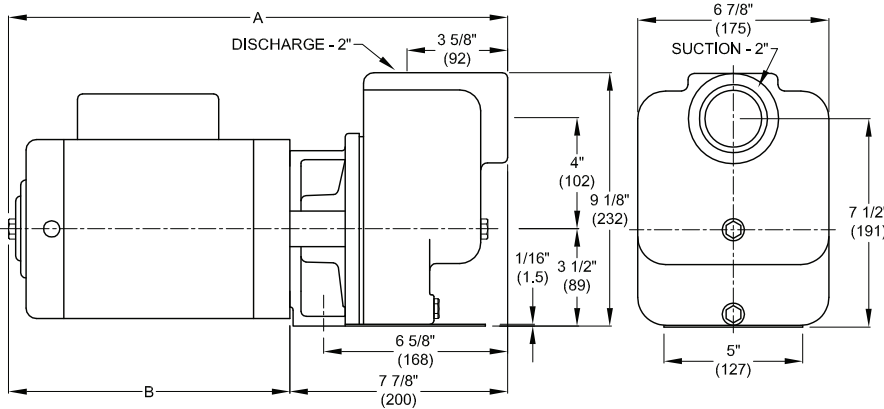

DIMENSIONS IN INCHES				
CATALOG NUMBER	SINGLE PHASE		THREE PHASE	
	A	B	A	B
5WT5	15 <sup>7</sup> / <sub>8</sub>	8	15 <sup>5</sup> / <sub>8</sub>	7 <sup>3</sup> / <sub>4</sub>
7WT5	16 <sup>7</sup> / <sub>8</sub>	9	16 <sup>7</sup> / <sub>8</sub>	9
10WT5	17 <sup>1</sup> / <sub>4</sub>	9 <sup>3</sup> / <sub>8</sub>	16 <sup>7</sup> / <sub>8</sub>	9
15WT5	18	10 <sup>1</sup> / <sub>8</sub>	16 <sup>7</sup> / <sub>8</sub>	9
20WT5	18	10 <sup>1</sup> / <sub>8</sub>	17 <sup>1</sup> / <sub>4</sub>	9 <sup>3</sup> / <sub>8</sub>
20WT5A	18	10 <sup>1</sup> / <sub>8</sub>	17 <sup>1</sup> / <sub>4</sub>	9 <sup>3</sup> / <sub>8</sub>

DIMENSIONS IN MILLIMETERS				
CATALOG NUMBER	SINGLE PHASE		THREE PHASE	
	A	B	A	B
5WT5	403	203	396	196
7WT5	428	228	428	228
10WT5	438	238	428	228
15WT5	457	257	428	228
20WT5	457	257	438	238
20WT5A	457	257	438	238

All models have 2" NPT suction and discharge.

#### SERIES: WT5X

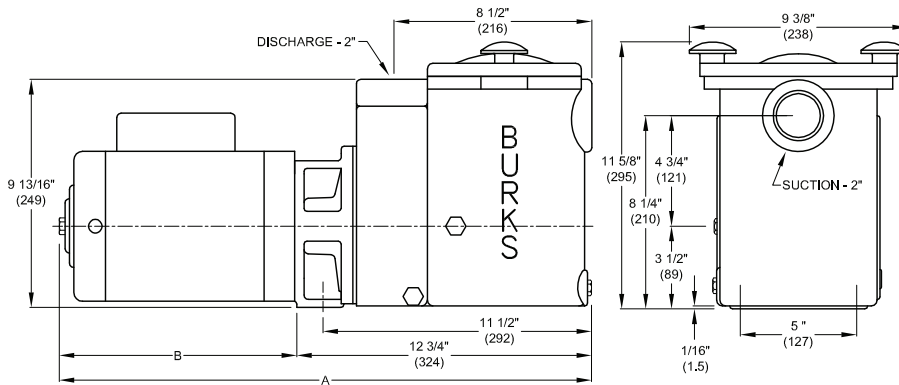

DIMENSIONS IN INCHES				
CATALOG NUMBER	SINGLE PHASE		THREE PHASE	
	A	B	A	B
5WT5X	20 <sup>3</sup> / <sub>4</sub>	8	20 <sup>1</sup> / <sub>2</sub>	7 <sup>3</sup> / <sub>4</sub>
7WT5X	21 <sup>1</sup> / <sub>4</sub>	9	21 <sup>1</sup> / <sub>4</sub>	9
10WT5X	22 <sup>1</sup> / <sub>8</sub>	9 <sup>3</sup> / <sub>8</sub>	21 <sup>1</sup> / <sub>4</sub>	9
15WT5X	22 <sup>7</sup> / <sub>8</sub>	10 <sup>1</sup> / <sub>8</sub>	21 <sup>1</sup> / <sub>4</sub>	9
20WT5X	22 <sup>7</sup> / <sub>8</sub>	10 <sup>1</sup> / <sub>8</sub>	22 <sup>1</sup> / <sub>8</sub>	9 <sup>3</sup> / <sub>8</sub>
20WT5AX	22 <sup>7</sup> / <sub>8</sub>	10 <sup>1</sup> / <sub>8</sub>	22 <sup>1</sup> / <sub>8</sub>	9 <sup>3</sup> / <sub>8</sub>

DIMENSIONS IN MILLIMETERS				
CATALOG NUMBER	SINGLE PHASE		THREE PHASE	
	A	B	A	B
5WT5X	527	203	520	196
7WT5X	552	228	552	228
10WT5X	561	238	552	228
15WT5X	581	257	552	228
20WT5X	581	257	561	238
20WT5AX	581	257	561	238

All models have 2" NPT suction and discharge.

DO NOT USE FOR CONSTRUCTION PURPOSES. CERTIFIED DRAWINGS AVAILABLE ON REQUEST

**Centrifugals - Self-Priming**

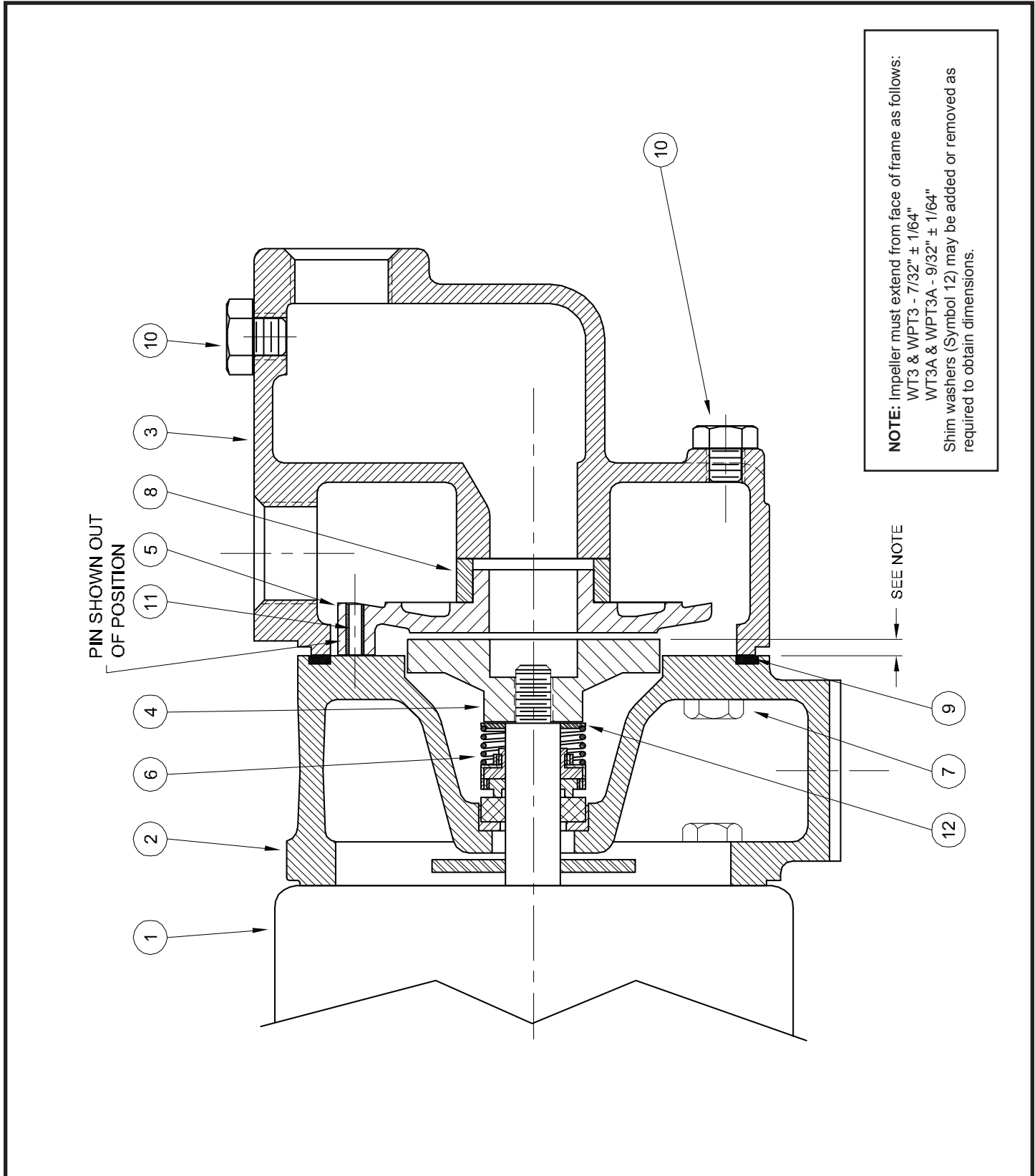

**Centrifugals - Self-Priming**

SYMBOL NUMBER	PART NUMBER	QTY	DESCRIPTION
10	04236	2	Plug, 1/4-18 NPT
11	20101	2	Roll Pin, 3/16x 3/4
12	20294	A/R	Shim Washer - .010"
	08542-A	A/R	Shim Washer - .031"
	20628	A/R	Shim Washer - .062"
Not Shown	21181-C	1	Lock Washer, 3 Phase
	21182	1	Lock Screw, 3 Phase
<b>ALL IRON PARTS</b>			
4	20097	1	Impeller
	20409-3	1	Impeller
10	04236-A	2	Plug
Not Shown	21181-A	1	Lock Washer, 3 Phase

(\* ) Series WT & WPT pumps have been manufactured with either cast iron or bronze impellers as standard. All replacement impellers will be bronze as listed, unless iron is specified.  
For iron impellers, omit the letter "A" from part number. EXAMPLE: 20409-3.

SYMBOL NUMBER	PART NUMBER	QTY	DESCRIPTION
1	003-211-371-02	1	Motor, 1/3HP, 115 Volt, 1Ph
	003-230-361-02	1	Motor, 1/3HP, 115/230 Volt, 1Ph
		1	Motor, 1/3HP, 230/460 Volt, 3Ph
2	20095	1	Adapter - WT3, WPT3
	20095-1	1	Adapter - WT3A, WPT3A
3	20096	1	Case
	20096-1	1	Case w/Priming Hole
* 4	20097-A	1	Impeller - WT3, WPT3
	20409-A-3	1	Impeller - WT3A, WPT3A
5	20098	1	Diffuser - WT3, WPT3
	20098-1	1	Diffuser - WT3A, WPT3A
6	09762	1	Mechanical Seal - Viton, WPT
	08514	1	Mechanical Seal - Buna-N, WT
7	01928	8	Cap Screw, 3/8-1" Lg
8	20099	1	Suction Sleeve - Viton, WPT
	20535	1	Suction Sleeve - Buna-N, WT
9	20100	1	Gasket, case to adapter

**WARNING:**  
CANCER AND REPRODUCTIVE HARM -  
WWW.P65WARNINGS.CA.GOV

