

Close Coupled Self Priming Pumps

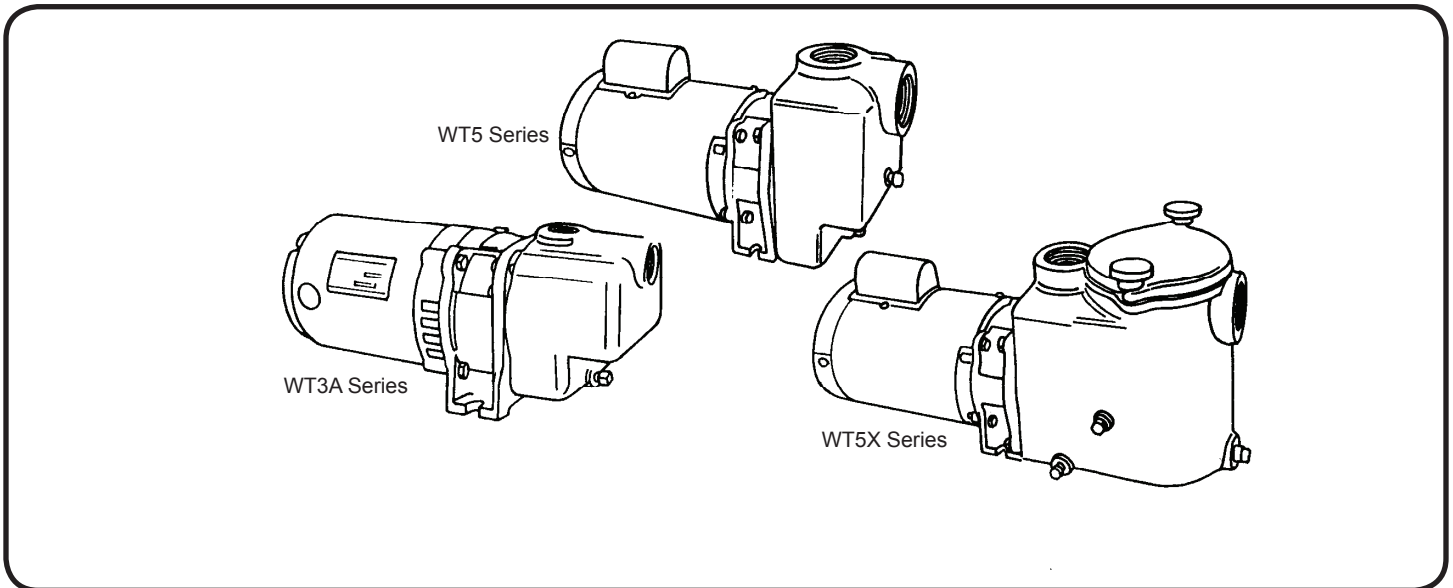

60 Hz - PERFORMANCE AND SELECTION 1.00 S.G. FLUIDS												
Catalog No.*		HP	Tappings		Capacity in GPM (LPS) - Total Head Feet (Meters)							
1 Phase	3 Phase		Suct.	Disch.	10' (3m)	15' (4.5m)	20' (6m)	25' (7.6m)	30' (9m)	35' (10.6m)	38' (11.5m)	
A3WT3A	33WT3A	1/3	1"	1"	42 (2.6)	40 (2.5)	37 (2.3)	33 (2.0)	26 (1.6)	17 (1.0)	9 (0.5)	

Catalog No.**	Catalog No. w/ Strainer**	HP	Tappings		Capacity in GPM (LPS) - Total Head Feet (Meters)								
			Suct.	Disch.	10' (3m)	20' (6m)	30' (9m)	40' (12m)	50' (15m)	60' (18m)	70' (21m)	80' (24m)	90' (27m)
5WT5	5WT5X	1/2	2"	2"	55 (3.4)	49 (3.0)	43 (2.7)	37 (2.3)	30 (1.8)	21 (1.3)	10 (0.6)	---	---
7WT5	7WT5X	3/4			72 (4.5)	70 (4.4)	66 (4.1)	61 (3.8)	52 (3.2)	40 (2.5)	24 (1.5)	---	---
10WT5	10WT5X	1			81 (5.1)	79 (4.9)	76 (4.7)	72 (4.5)	65 (4.1)	54 (3.4)	40 (2.5)	20 (1.2)	---
15WT5	15WT5X	1½			86 (5.4)	86 (5.4)	84 (5.2)	80 (5.0)	75 (4.7)	67 (4.2)	54 (3.4)	38 (2.3)	18 (1.1)
20WT5	20WT5X	2			94 (5.9)	93 (5.8)	92 (5.8)	89 (5.6)	85 (5.3)	78 (4.9)	67 (4.2)	50 (3.1)	30 (1.8)
20WT5A	20WT5AX	2			140 (8.8)	140 (8.8)	132 (8.3)	119 (7.5)	99 (6.2)	---	---	---	---

(**) Catalog numbers are for units with single phase motors. For three phase, add prefix, "3". Example: 35WT5X.

(*) Maximum suction lift on WT3A - 7ft.
Maximum suction lift on WT5 series - 20ft.

For Water and Other 1.00 S.G. Fluids

3500 RPM - 60 Hz.

Close Coupled Self Priming Pumps



- Compact, Close-Coupled Design
- Rugged Bronze-Fitted Cast Iron Construction
- Leakproof Mechanical Shaft Seal
- Non-Clogging, Bronze Semi-Open Impeller
- Stainless Steel Shaft
- Back Pull-Out Design For Easy Servicing
- Available With or Without Built-In Basket Type Strainer
- Self-Priming, Once Case is Filled With Fluid
- Diaphragms, Flappers or Check Valves Are Not Required In Pump Suction Piping. But Are Recommended
- EVERY pump is factory tested and will meet Hydraulic Institute standards.

MOTOR INFORMATION

WT3A Series have NEMA Jet Pump Motors. WT5 & WT5X Series have rugged Swimming Pool type motors with oversize ball/ball bearing construction. All motors have open-drip proof construction and are rated with standard NEMA Jet Pump service factors for continuous duty operation at all ratings shown. Voltages may differ from some suppliers. Consult factory. Overload Protection: All single phase motors have built-in overload protection. All three phase motors must be installed with a magnetic starter which provides full 3-leg protection. Failure to use correct starter and overloads will void motor warranty. All Single Phase Open Drip Proof Motors Are U.L. Recognized.



WARNING:
CANCER AND REPRODUCTIVE HARM -
WWW.P65WARNINGS.CA.GOV

RATINGS

A3WT3A-1/3 HP, Single Phase, 115V, 60Hz, 3500RPM, ODP, Split Phase.
3WT3A-1/3 HP, Single Phase, 115/230V, 60Hz, 3500RPM, ODP, Capacitor Start.
33WT3A-1/3 HP, Three Phase, 230/460V, 60Hz, 3500RPM, ODP
WT5 & WT5X Series: Single Phase: 1/2 thru 2HP, 115/230V, 60HZ, 3500RPM, ODP, Capacitor Start.
Three Phase: 1/2 thru 2HP, 230/460V, 60HZ, 3500RPM, ODP.

PumpAgents.com <i>Wholesale Pump Agents</i>	CONDITIONS
	225°F (107°C)
	INLET PRESSURE (WT3 & WT5)
	100 PSI (689kPa)
	INLET PRESSURE (WT5X)
15 PSI (103kPa)	
CASING WORKING PRESSURE (WT3 & WT5)	
165 PSI (1137kPa)	
CASING WORKING PRESSURE (WT5X)	
60 PSI (413kPa)	

MATERIALS OF CONSTRUCTION		
PART	CAST IRON	BRONZE FITTED
Adapter	Cast Iron	Cast Iron
Case	Cast Iron	Cast Iron
Diffuser	Cast Iron	Cast Iron
Impeller	Cast Iron	Bronze
Shaft	Stainless	Stainless
Shaft Seal	Carbon-Ceramic SS - Buna-N	
Suction Sleeve	Buna-N	Buna-N
Strainer Gasket	Buna-N	Buna-N
Strainer Basket	Stainless	Stainless
All Plugs	Brass	Stainless

Close Coupled Self Priming Pumps

SERIES: WT3A



DIMENSIONS IN INCHES				
CATALOG NUMBER	SINGLE PHASE		THREE PHASE	
	A	B	A	B
A3WT3A	15	7 ⁵ / ₈	---	---
3WT3A	15 ¹ / ₂	8 ³ / ₈	---	---
33WT3A	---	---	15 ¹ / ₂	8 ³ / ₈

DIMENSIONS IN MILLIMETERS				
CATALOG NUMBER	SINGLE PHASE		THREE PHASE	
	A	B	A	B
A3WT3A	381	200	---	---
3WT3A	393	212	---	---
33WT3A	---	---	393	212

All models have 1" NPT suction and discharge.

SERIES: WT5



DIMENSIONS IN INCHES				
CATALOG NUMBER	SINGLE PHASE		THREE PHASE	
	A	B	A	B
5WT5	15 ⁷ / ₈	8	15 ⁵ / ₈	7 ³ / ₄
7WT5	16 ⁷ / ₈	9	16 ⁷ / ₈	9
10WT5	17 ¹ / ₄	9 ³ / ₈	16 ⁷ / ₈	9
15WT5	18	10 ¹ / ₈	16 ⁷ / ₈	9
20WT5	18	10 ¹ / ₈	17 ¹ / ₄	9 ³ / ₈
20WT5A	18	10 ¹ / ₈	17 ¹ / ₄	9 ³ / ₈

DIMENSIONS IN MILLIMETERS				
CATALOG NUMBER	SINGLE PHASE		THREE PHASE	
	A	B	A	B
5WT5	403	203	396	196
7WT5	428	228	428	228
10WT5	438	238	428	228
15WT5	457	257	428	228
20WT5	457	257	438	238
20WT5A	457	257	438	238

All models have 2" NPT suction and discharge.

SERIES: WT5X

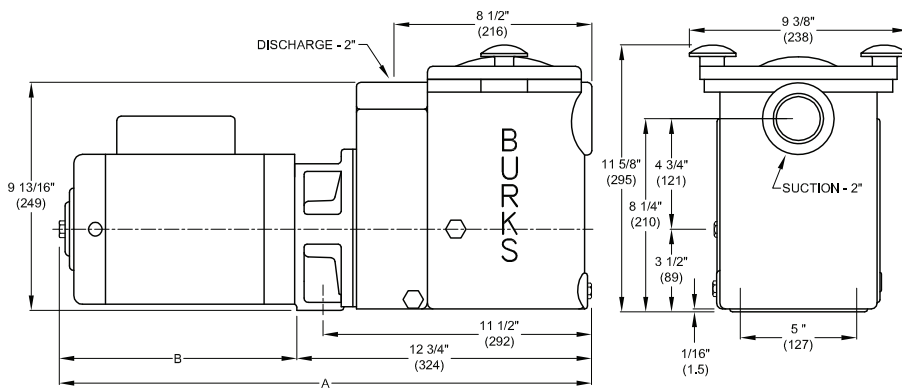

DIMENSIONS IN INCHES				
CATALOG NUMBER	SINGLE PHASE		THREE PHASE	
	A	B	A	B
5WT5X	20 ³ / ₄	8	20 ¹ / ₂	7 ³ / ₄
7WT5X	21 ¹ / ₄	9	21 ¹ / ₄	9
10WT5X	22 ¹ / ₈	9 ³ / ₈	21 ¹ / ₄	9
15WT5X	22 ⁷ / ₈	10 ¹ / ₈	21 ¹ / ₄	9
20WT5X	22 ⁷ / ₈	10 ¹ / ₈	22 ¹ / ₈	9 ³ / ₈
20WT5AX	22 ⁷ / ₈	10 ¹ / ₈	22 ¹ / ₈	9 ³ / ₈

DIMENSIONS IN MILLIMETERS				
CATALOG NUMBER	SINGLE PHASE		THREE PHASE	
	A	B	A	B
5WT5X	527	203	520	196
7WT5X	552	228	552	228
10WT5X	561	238	552	228
15WT5X	581	257	552	228
20WT5X	581	257	561	238
20WT5AX	581	257	561	238

All models have 2" NPT suction and discharge.

DO NOT USE FOR CONSTRUCTION PURPOSES. CERTIFIED DRAWINGS AVAILABLE ON REQUEST



Centrifugals - Self-Priming



NOTE: Impeller must extend from face of frame as follows:
Pumps with 20405 Diffuser - 33/64"
20405-1 Diffuser - 9/32"
20406 Diffuser - 15/64"
Shim washers (Symbol 15) may be added or removed as required to obtain dimensions.

1 - MOTORS			HP
RPM & PHASE	PART NUMBER		
FOR WT5 & WPT5 (Std) SERIES OPEN DRIP PROOF			
3500 RPM Single Phase (ODP)	005-211-371-02	1/2	
	007-211-371-02	3/4	
	010-211-371-02	1	
	015-211-371-02	1½	
	020-211-371-02	2	
030-215-371-02	3		
3500 RPM Three Phase (ODP)	005-230-371-02	1/2	
	007-230-371-02	3/4	
	010-230-371-02	1	
	015-230-371-02	1½	
	020-230-371-02	2	
030-230-371-02	3		
FOR WST5 (Std) SERIES EXPLOSION PROOF			
3500 RPM Single Phase (XP)	005-211-374-02	1/2	
	007-211-374-02	3/4	
	010-211-374-02	1	
	015-211-374-02	1½	
020-211-374-02	2		
3500 RPM Three Phase (XP)	005-230-364-02	1/2	
	007-230-364-02	3/4	
	010-230-364-02	1	
	015-230-364-02	1½	
020-230-364-02	2		

Centrifugals - Self-Priming

SYMBOL NUMBER	PART NUMBER	QTY	DESCRIPTION
◆ 9	08507	1	Flat Gasket
	22021	1	O-Ring - Buna-N, WT5 & WST5 (Std)
	22020	1	O-Ring - Viton, WPT5 (Std)
	22133	1	O-Ring - EPDM**
	22102	1	O-Ring - Teflon
10	09453	2	Pin
11	20405	1	Diffuser - 20WT5A & 320WT5A 30WPT5A & 330WPT5A X20WST5A & X320WST5A
12	20405-1	1	Diffuser - 5WPT5 & 35WPT5
	20406	1	Diffuser - All except above
	04231	1	Suction Sleeve - Buna-N, WT5 & WST5 (Std)
13	09695	1	Suction Sleeve - Viton, WPT5 (Std)
	20285	1	Suction Sleeve - EPT**
	20295	1	Case
14	04236	2	Plug 1/4-18 NPT
15	20628	1	Washer, 1/16 - 7WPT5 & 37WPT5
15	08542-A	A/R	Washer, .032"
	20294	A/R	Washer, .010"
	20497	A/R	Washer, .005"
ALL IRON PARTS			
5		1	Impeller (Omit Letter A)
14	04236-A	2	Plug, 1/4-18 NPT

(*) WT5, WPT5 & WST5 Series pumps have been manufactured with either cast iron or bronze impellers as standard. All replacement impellers will be bronze as listed, unless iron is specified. For iron impellers, omit the letter "A" from part number. EXAMPLE: 20409-8.

(**) For hot water or caustic service.

(◆) Series WT5, WPT5 & WST5 pumps have been manufactured with either a flat or O-ring type gasket. Determine which type is required before ordering. When in doubt, order flat gasket.

SYMBOL NUMBER	PART NUMBER	QTY	DESCRIPTION	
2	08105	1	Slinger Washer	
3	08514	1	Mechanical Seal - Buna-N (Std)	
	09762	1	Mechanical Seal - Viton	
	20764-C	1	Mechanical Seal - EPT**	
	01928	4	Cap Screw 3/8 x 1" Lg	
FOR SERIES WT5, 1 & 3 PHASE				
* 5	20409-A-8	1	Impeller, 5WPT5	
	20409-A-2	1	Impeller, 7WPT5	
	20409-A-4	1	Impeller, 10WPT5	
	20409-A-1	1	Impeller, 15WPT5	
	20409-A	1	Impeller, 20WPT5	
	20408-A	1	Impeller, 20WPT5A	
	FOR SERIES WPT5, 1 & 3 PHASE			
	20407-A	1	Impeller, 5WPT5	
	20409-A-6	1	Impeller, 7WPT5	
	20409-A-5	1	Impeller, 10WPT5	
20409-A-2	1	Impeller, 15WPT5		
20409-A-4	1	Impeller, 20WPT5		
20409-A	1	Impeller, 20WPT5A		
20408-A	1	Impeller, 30WPT5A		
FOR SERIES WST5, 1 & 3 PHASE				
6	20409-A-7	1	Impeller, X5WST5	
	20409-A-5	1	Impeller, X7WST5	
	20409-A-2	1	Impeller, X10WST5	
	20409-A-1	1	Impeller, X15WST5	
	20409-A	1	Impeller, X20WST5	
	20408-A	1	Impeller, X20WST5A	
	20459	1	Impeller Lock Nut	
	04235	4	Cap Screw 3/8 x 1 1/4	
7	20245	1	Adapter - 20WT5A & 320WT5A 5WPT5 & 35WPT5 30WPT5A & 330WPT5A X20WST5A & X320WST5A	
	20245-1	1	Adapter - All except above	
8				

WARNING:
CANCER AND REPRODUCTIVE HARM -
WWW.P65WARNINGS.CA.GOV

