

Close Coupled Regenerative Turbine

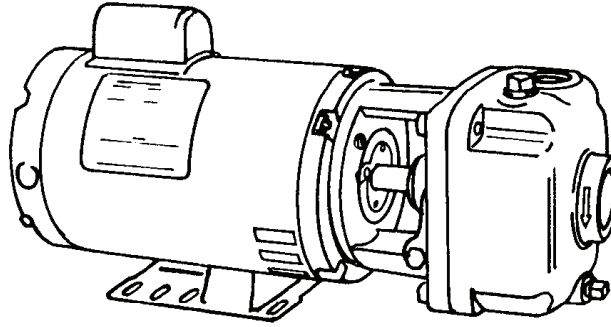

4CS - 1725 RPM - 60Hz.

CS - 3450 RPM - 60Hz.

(See Individual curves for symbol number)

Symbol Number	HP	*MAXIMUM HEAD	
		Catalog Number	
		1 - Phase	3 - Phase
1	1/3	34CS5M	334CS5M
2	1/3	34CS6M	334CS6M
3	1/2	54CS6M	354CS6M
4	1/3	34CS7M	334CS7M
5	1/2	54CS7M	354CS7M
6	1/2	54CS8M	354CS8M
7	1	10CS5M	310CS5M
8	1 1/2	15CS5M	315CS5M
9	1	10CS6M	310CS6M
10	1 1/2	15CS6M	315CS6M
11	2	20CS6M	320CS6M
12	1 1/2	15CS7M	315CS7M
13	2	20CS7M	320CS7M
14	3	----	330CS7M
15	2	20CS8M	320CS8M
16	3	----	330CS8M
17	5	----	350CS8M
18	3	----	330CS9M
19	5	----	350CS9M

(*) For Standard Pumps with ODP motors

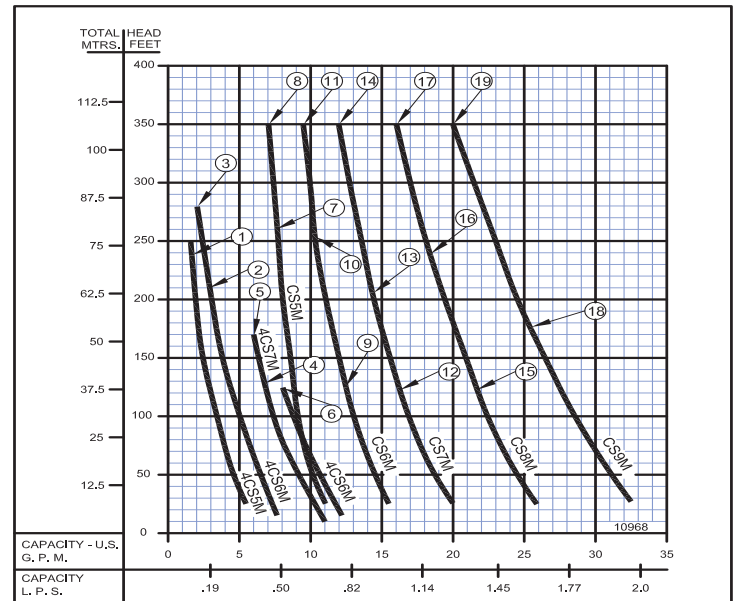

CS - 2900 RPM - 50Hz.

(See Individual curves for symbol number)

Symbol Number	HP	MAXIMUM HEAD
		Catalog Number
* 1	2.0	L320CS9M
2	2.6	L330CS9M
3	4.0	L340CS9M
4	1.5	L315CS8M
* 5	2.0	L320CS8M
6	2.6	L330CS8M
7	1.5	L315CS7M
* 8	2.0	L320CS7M
9	2.6	L330CS7M
10	1.0	L310CS6M
11	1.5	L315CS6M
* 12	2.0	L320CS6M
13	1.0	L310CS5M
14	1.0	L315CS5M

(*) Pump numbers 1, 5, 8 & 12 are the only pump available in single phase 115/230 volt. All of the pumps above are available with stuffing box.

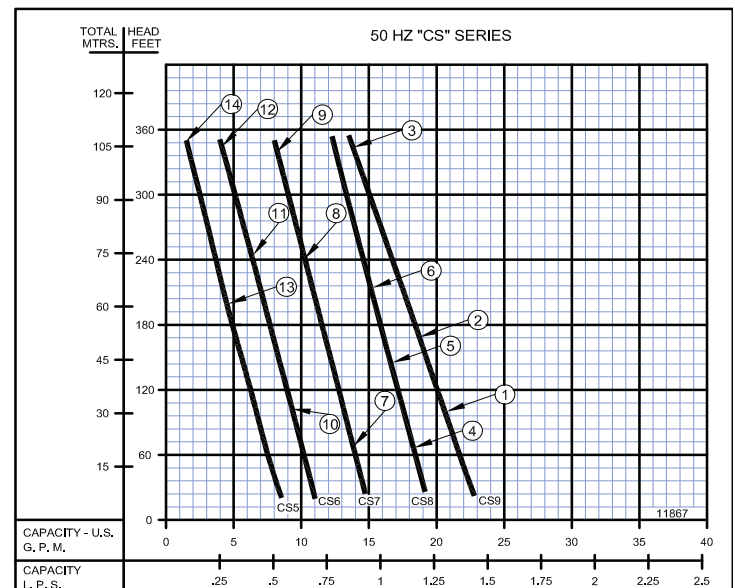

Close Coupled Regenerative Turbine

60 HZ - PERFORMANCE & SELECTION CHART																				
Catalog Number		HP	Tappings		PSI Feet	TOTAL HEAD														
			Suct. NPT	Disc. NPT		8.6 20	17.2 40	26 60	43.3 100	54.1 125	64.9 150	75.8 175	86.6 200	97.4 225	108.3 250	119.1 275	130 300	140.1 325	151.6 350	
1 Phase	3 Phase	CAPACITY IN GPM																		
1750 RPM	34CS5M	334CS5M	1/3	1 1/4	1	5.8	4.9	4.3	3.3	2.8	2.4	2.1	1.8	1.6						
	34CS6M	334CS6M	1/3			7.8	6.9	6.3	5.2	4.6	4.1	3.7	3.3							
	54CS6M	354CS6M	1/2			7.8	6.9	6.3	5.2	4.6	4.1	3.7	3.3	2.9	2.6	2.3				
	34CS7M	334CS7M	1/3			10.4	9.4	8.5	7.2	6.5	5.9	5.4								
	54CS7M	354CS7M	1/2			10.4	9.4	8.5	7.2	6.5	5.9	5.4								
	54CS8M	354CS8M	1/2			12.2	11.3	10.4	9.0	8.2										
3450 RPM	10CS5M	310CS5M	1	1 1/4	1	11	10.6	10.1	9.3	9	8.5	8.2	8	7.7						
	15CS5M	315CS5M	1 1/2			11	10.6	10.1	9.3	9	8.5	8.2	8	7.7	7.5	7.4	7.2	7.1		
	10CS6M	310CS6M	1			16	15.2	14.5	13.5	12.8										
	15CS6M	315CS6M	1 1/2			16	15.2	14.5	13.5	12.8	12.4	12	11.5	11	10.7					
	20CS6M	320CS6M	2			16	15.2	14.5	13.5	12.8	12.4	12	11.5	11	10.7	10.5	10.1	9.7	9.5*	
	15CS7M	315CS7M	1 1/2			20.5	19.6	19.5	17.3											
	20CS7M	320CS7M	2			20.5	19.6	19.5	17.3	16.5	16	15.3	14.7							
	----	330CS7M	3			20.5	19.6	19.5	17.3	16.5	16	15.3	14.7	14.2	13.7	13.3	12.8	12.5	12*	
	20CS8M	320CS8M	2			26.5	25.5	24.6	23	22										
	----	330CS8M	3			26.5	25.5	24.6	23	22	21.3	20.5	19.8	19.2						
----	350CS8M	5	26.5	25.5	24.6	23	22	21.3	20.5	19.8	19.2	18.5	18	17.4	16.8	16.3*				
----	330CS9M	3	32.5	31.5	30.5	28.6	27.5	26.5												
----	350CS9M	5	32.5	31.5	30.5	28.6	27.5	26.5	25.6	24.7	23.8	23	22.2	21.5	20.7	20*				

* Rated to 358 ft (155 psi) per performance curve.

60 HZ - PERFORMANCE & SELECTION CHART																				
Catalog Number		HP	Tappings		kPa Meters	TOTAL HEAD														
			Suct. NPT (in)	Disc. NPT (in)		59 6.1	119 12.1	179 18.2	299 30.5	373 38.1	447 45.7	523 53.3	597 61	672 68.6	747 76.2	821 83.8	896 91.4	966 99.1	1045 106.6	
1 Phase	3 Phase	CAPACITY IN LPS																		
1750 RPM	34CS5M	334CS5M	1/3	1 1/4	1	0.36	0.30	0.27	0.20	0.17	0.15	0.13	0.11	1.6						
	34CS6M	334CS6M	1/3			0.49	0.43	0.39	0.32	0.29	0.25	0.23	0.20							
	54CS6M	354CS6M	1/2			0.49	0.43	0.39	0.32	0.29	0.25	0.23	0.20	0.18	0.16	0.14				
	34CS7M	334CS7M	1/3			0.65	0.59	0.53	0.45	0.41										
	54CS7M	354CS7M	1/2			0.65	0.59	0.53	0.45	0.41	0.37	0.34								
	54CS8M	354CS8M	1/2			0.76	0.71	0.65	0.56	0.51										
3450 RPM	10CS5M	310CS5M	1	1 1/4	1	0.69	0.66	0.63	0.58	0.56	0.53	0.51	0.50	0.48						
	15CS5M	315CS5M	1 1/2			0.69	0.66	0.63	0.58	0.56	0.53	0.51	0.50	0.48	0.47	0.46	0.45	0.44		
	10CS6M	310CS6M	1			1.00	0.95	0.91	0.85	0.80										
	15CS6M	315CS6M	1 1/2			1.00	0.95	0.91	0.85	0.80	0.78	0.75	0.72	0.69	0.67					
	20CS6M	320CS6M	2			1.00	0.95	0.91	0.85	0.80	0.78	0.75	0.72	0.69	0.67	0.66	0.63	0.61	0.59	
	15CS7M	315CS7M	1 1/2			1.29	1.24	1.23	1.09											
	20CS7M	320CS7M	2			1.29	1.24	1.23	1.09	1.04	1.00	0.96	0.92							
	----	330CS7M	3			1.29	1.24	1.23	1.09	1.04	1.00	0.96	0.92	0.89	0.86	0.83	0.80	0.78	0.75	
	20CS8M	320CS8M	2			1.67	1.60	1.55	1.45	1.38										
	----	330CS8M	3			1.67	1.60	1.55	1.45	1.38	1.34	1.29	1.24	1.21						
----	350CS8M	5	1.67	1.60	1.55	1.45	1.38	1.34	1.29	1.24	1.21	1.16	1.13	1.09	1.05	1.02				
----	330CS9M	3	2.05	1.98	1.92	1.80	1.73	1.67												
----	350CS9M	5	2.05	1.98	1.92	1.80	1.73	1.67	1.61	1.55	1.50	1.45	1.40	1.35	1.30	1.26				

NOTE: When pumping hot water over 180°F (82.2°C), check the NPSH available in the pumping system against the required pump NPSH shown on pump performance curves. Available NPSH must be greater than required NPSH.

Close Coupled Regenerative Turbine

50 HZ - PERFORMANCE & SELECTION CHART																					
Catalog Number		HP	Tappings		PSI Feet	TOTAL HEAD															
			Suct. NPT	Disc. NPT		8.6	17.2	26	43.3	54.1	64.9	75.8	86.6	97.4	108.3	119.1	130	140.1	151.6		
1 Phase	3 Phase				20	40	60	100	125	150	175	200	225	250	275	300	325	350			
CAPACITY IN GPM																					
	L310CS5M	1	1 1/4	1		8.5	8.0	7.5	6.5	6.0	5.5	5.0	4.5	4.0	3.5	3.0	2.5	2.0	1.5*		
	L315CS5M	1.5						8.5	8.0	7.5	6.5	6.0	5.5	5.0	4.5	4.0	3.5	3.0	2.5	2.0	1.5*
	L310CS6M	1						11.0	10.5	10.0	9.3	9.0	8.3	7.8	7.3	6.8	6.3				
	L315CS6M	1.5						11.0	10.5	10.0	9.3	9.0	8.3	7.8	7.3	6.8	6.3				
L20CS6M	L320CS6M	2						11.0	10.5	10.0	9.3	9.0	8.3	7.8	7.3	6.8	6.3	5.8	5.0	4.5	4.0*
	L315CS7M	1.5						14.8	14.3	14.0	13.0	12.8									
	L330CS7M	2.6						14.8	14.3	14.0	13.0	12.8	12.0	11.6	11.0	10.5	10.0	9.5	9.0	8.5	8.0*
L20CS7M	L320CS7M	2						14.8	14.3	14.0	13.0	12.8	12.0	11.6	11.0	10.5					
	L315CS8M	1.5						19.0	18.8	18.3											
	L330CS8M	2.6						19.0	18.8	18.3	17.5	17.0	16.5	16.0	15.5	15.0	14.5	14.0	13.3	13.0	12.3*
L20CS8M	L320CS8M	2						19.0	18.8	18.3	17.5	17.0	16.5								
L20CS9M	L320CS9M	2						22.8	22.3	21.8	20.5										
----	L330CS9M	2.6						22.8	22.3	21.8	20.5	20.0	19.3	18.8							
----	L340CS9M	4.0						22.8	22.3	21.8	20.5	20.0	19.3	18.8	18.0	17.0	16.5	15.8	15.0	14.3	13.5*

2900 RPM

* Rated to 358 ft (155 psi) per performance curve.

50 HZ - PERFORMANCE & SELECTION CHART																					
Catalog Number		HP	Tappings		kPa Meters	TOTAL HEAD															
			Suct. NPT (in)	Disc. NPT (in)		59	119	179	299	373	447	523	597	672	747	821	896	966	1045		
1 Phase	3 Phase				6.1	12.1	18.2	30.5	38.1	45.7	53.3	61	68.6	76.2	83.8	91.4	99.1	106.6			
CAPACITY IN LPS																					
	L310CS5M	1	1 1/4	1		0.54	0.50	0.47	0.41	0.38	0.35	0.32	0.28	0.25	0.22	0.19	0.16	0.13	0.09		
	L315CS5M	1.5						0.54	0.50	0.47	0.41	0.38	0.35	0.32	0.28	0.25	0.22	0.19	0.16	0.13	0.09
	L310CS6M	1						0.69	0.66	0.63	0.58	0.56	0.52	0.49	0.46	0.42	0.39				
	L315CS6M	1.5						0.69	0.66	0.63	0.58	0.56	0.52	0.49	0.46	0.42	0.39				
L20CS6M	L320CS6M	2						0.69	0.66	0.63	0.58	0.56	0.52	0.49	0.46	0.42	0.39	0.36	0.31	0.28	0.25
	L315CS7M	1.5						0.93	0.90	0.88	0.82	0.80									
	L330CS7M	2.6						0.93	0.90	0.88	0.82	0.80	0.75	0.73	0.69	0.66	0.63	0.59	0.56	0.53	0.50
L20CS7M	L320CS7M	2						0.93	0.90	0.88	0.82	0.80	0.75	0.73	0.69	0.66					
	L315CS8M	1.5						1.19	1.18	1.15											
	L330CS8M	2.6						1.19	1.18	1.15	1.10	1.07	1.04	1.00	0.97	0.94	0.91	0.88	0.83	0.82	0.77
L20CS8M	L320CS8M	2						1.19	1.18	1.15	1.10	1.07	1.04								
L20CS9M	L320CS9M	2						1.43	1.40	1.37	1.29										
	L330CS9M	2.6						1.43	1.40	1.37	1.29	1.26	1.21	1.18							
	L340CS9M	4.0						1.43	1.40	1.37	1.29	1.26	1.21	1.18	1.13	1.07	1.04	0.99	0.94	0.90	0.85

2900 RPM

NOTE: When pumping hot water over 180°F (82.2°C), check the NPSH available in the pumping system against the required pump NPSH shown on pump performance curves. Available NPSH must be greater than required NPSH.

Close Coupled Regenerative Turbine

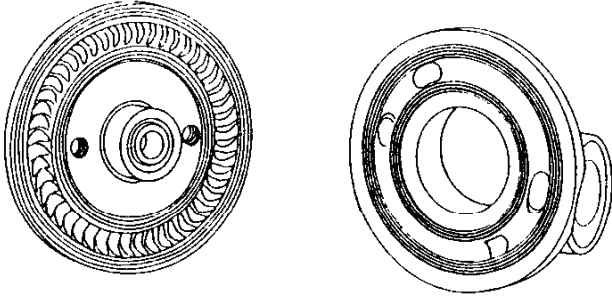

BURKS exclusive unique regenerative type turbine pumps are designed to handle clear water and many other non-abrasive, lower viscosity liquids on high pressure, low capacity applications with the greatest possible efficiency.

BURKS is the only turbine pump with Life-Lok® External Impeller Adjustment feature that allows readjustment of impeller without disturbing piping, disassembling pump or replacing parts. Gives up to 40% longer service life than turbine pumps of other designs.

- Self-Priming
- Compact, Space-saving size
- No coupling - eliminates misalignment problems
- Dependable carbon/ceramic mechanical shaft seal for temperatures to 225°F (107°C).
- Bronze impeller with Monel blades - the only moving part
- Bronze raceway with cast-in vortex pockets - will not vapor lock
- #303 Stainless Steel pump shaft
- Easy to service
- Every pump factory tested
- Available Bronze fitted, All Bronze, Stainless Steel

**WARNING:**

CANCER AND REPRODUCTIVE HARM -
WWW.P65WARNINGS.CA.GOV

MAXIMUM OPERATING CONDITIONS	
TEMPERATURE (For Standard Buna-N Seal)	225°F (107°C)
INLET PRESSURE	100 PSI (689kPa)
CASING WORKING PRESSURE	250 PSI (1723kPa)

MOTOR INFORMATION**4CS Series:**

Single Phase motors are 115/208-230 Volt, 60Hz, 1750RPM
Three Phase motors are 208-230/460 Volts, 60/50Hz, 1750/1450RPM

CS Series:

Single Phase motors are 115/208-230 Volt, 60 Hz, 3450RPM
Three Phase 1, 1 1/2 & 2HP. - 208-230/460 Volt, 60/50 Hz., 3450/2900 RPM

Three Phase 3 & 5 HP - 208-230/460 Volt, 60 Hz, 3450RPM

Standard pump motors have open drip proof construction and are rated with jet pump service factors for continuous duty operation at all ratings shown.

Single phase motors are capacitor start/induction run with built-in overload protection.

Three phase motors require a magnetic type starter which provides full 3-leg overload protection. Failure to use the correct starter and overloads will void the warranty.

FOR TEMPERATURES TO 500°F (260°C).

Series CS Pumps are available in a Jacketed Seal Cavity design for pumping hot oil, hot water and heat transfer fluids in common use in high temperature heating or cooling applications. This feature greatly extends seal life in high temperature applications. To order, add suffix "J" to pump catalog number for temperatures below 400°F (204°C) and add suffix "JK" to pump catalog number for temperatures over 400°F (204°C). Example: 15CS5MJ. See Section on High Temperature Pumps for more information.

MATERIALS OF CONSTRUCTION			
PART	BRONZE FITTED	ALL BRONZE	STAINLESS STEEL
Frame	Cast Iron	Bronze	#316 Stainless
Case	Cast Iron	Bronze	#316 Stainless
Impeller	Bronze (Monel Blades)	Bronze (Monel Blades)	#303 Stainless
Raceway	Bronze	Bronze	#303 Stainless
Shaft	#303 Stainless	#303 Stainless	#303 Stainless
Shaft Seal	Carbon-Ceramic SS - Buna-N	Carbon-Ceramic SS - Buna-N	Carbon-Ceramic SS - Buna-N

Close Coupled Regenerative Turbine

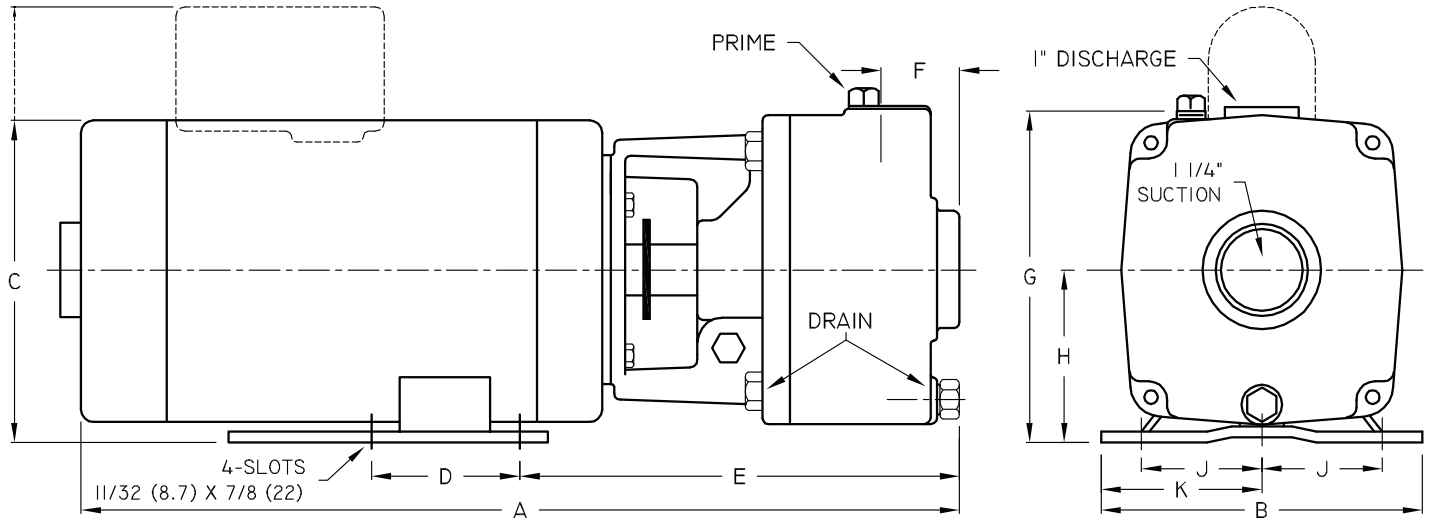

DIMENSIONS IN INCHES - ODP																			
Series	HP	Tappings		1 PH A	1 PH A (S.S.)	3 PH A	3 PH A (S.S.)	B	1 PH C	3 PH C	D	E	E (S.S.)	F	F (S.S.)	G	H	J	K
		Disc. NPT (in)	Suct. NPT (in)																
4CS	1/3	1	1 1/4	17 5/8	18 1/16	16 3/8	16 13/16	6 1/2	6 5/8	6 5/8	3	9	9 7/16	1 3/4	1 3/4	6 3/4	3 1/2	2 7/16	3 1/4
	1/2	1	1 1/4	17 5/8	18 1/16	16 5/8	16 13/16	6 1/2	6 5/8	6 5/8	3	9	9 7/16	1 3/4	1 3/4	6 3/4	3 1/2	2 7/16	3 1/4
CS	1	1	1 1/4	18 5/16	18 3/4	18 5/16	18 3/4	6 1/2	6 5/8	6 5/8	3	9	9 7/16	1 3/4	1 3/4	6 3/4	3 1/2	2 7/16	3 1/4
	1 1/2	1	1 1/4	19 1/16	19 1/2	19 1/16	19 1/2	6 1/2	8 13/16	6 5/8	3	9	9 7/16	1 3/4	1 3/4	6 3/4	3 1/2	2 7/16	3 1/4
	2	1	1 1/4	19 9/16	20	19 1/16	19 1/2	6 1/2	8 13/16	6 5/8	3	9	9 7/16	1 3/4	1 3/4	6 3/4	3 1/2	2 7/16	3 1/4
	3	1	1 1/4	---	---	19 9/16	20	6 1/2	---	6 5/8	6 5/8	3	9	9 7/16	1 3/4	1 3/4	6 3/4	3 1/2	2 7/16
	5	1	1 1/4	---	---	20 15/16	21 3/8	6 1/2	---	6 5/8	3	9	9 7/16	1 3/4	1 3/4	6 3/4	3 1/2	2 7/16	3 1/4

DIMENSIONS IN INCHES - TEFC																			
Series	HP	Tappings		1 PH A	1 PH A (S.S.)	3 PH A	3 PH A (S.S.)	B	1 PH C	3 PH C	D	E	E (S.S.)	F	F (S.S.)	G	H	J	K
		Disc. NPT (in)	Suct. NPT (in)																
CS	1 1/2	1	1 1/4	---	---	18 1/2	19 1/8	6 1/2	---	6 5/8	3	9	9 7/16	1 3/4	1 3/4	6 3/4	3 1/2	2 7/16	3 1/4
	2	1	1 1/4	---	---	18 1/2	19 1/8	6 1/2	---	6 5/8	3	9	9 7/16	1 3/4	1 3/4	6 3/4	3 1/2	2 7/16	3 1/4
	3	1	1 1/4	---	---	20 3/4	21 3/8	6 1/2	---	6 5/8	3	9	9 7/16	1 3/4	1 3/4	6 3/4	3 1/2	2 7/16	3 1/4
	5	1	1 1/4	---	---	20 5/8	21 1/4	6 1/2	---	6 5/8	3	9	9 7/16	1 3/4	1 3/4	6 3/4	3 1/2	2 7/16	3 1/4

A strainer, approximately 20 mesh, should be installed on the suction side of the pump to prevent chips, scale or hard foreign particales from entering the pump and damaging the raceway and impeller.

Close Coupled Regenerative Turbine

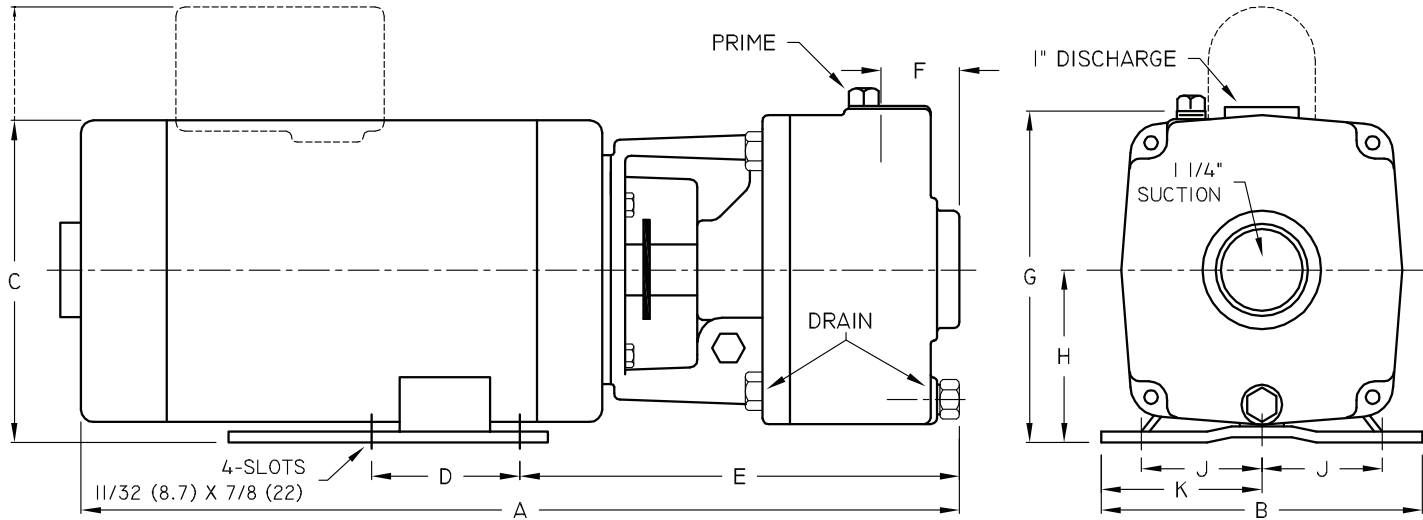

Series	HP	Tappings		DIMENSIONS IN MILLIMETERS - ODP															
		Disc. NPT (in)	Suct. NPT (in)	1 PH A	1 PH A (S.S.)	3 PH A	3 PH A (S.S.)	B	1 PH C	3 PH C	D	E	E (S.S.)	F	F (S.S.)	G	H	J	K
4CS	1/3	1	1 1/4	447	459	415	427	165	168	168	76	228	240	44	44	171	89	62	82
	1/2	1	1 1/4	447	459	422	427	165	168	168	76	228	240	44	44	171	89	62	82
CS	1	1	1 1/4	465	476	465	476	165	168	168	76	228	240	44	44	171	89	62	82
	1 1/2	1	1 1/4	484	495	484	495	165	223	168	76	228	240	44	44	171	89	62	82
	2	1	1 1/4	496	508	484	495	165	223	168	76	228	240	44	44	171	89	62	82
	3	1	1 1/4	---	---	496	508	165	---	168	76	228	240	44	44	171	89	62	82
	5	1	1 1/4	---	---	531	543	165	---	168	76	228	240	44	44	171	89	62	82

Series	HP	Tappings		DIMENSIONS IN MILLIMETERS - TEFC															
		Disc. NPT (in)	Suct. NPT (in)	1 PH A	1 PH A (S.S.)	3 PH A	3 PH A (S.S.)	B	1 PH C	3 PH C	D	E	E (S.S.)	F	F (S.S.)	G	H	J	K
CS	1 1/2	1	1 1/4	---	---	470	486	165	---	168	76	228	240	44	44	171	89	62	82
	2	1	1 1/4	---	---	470	486	165	---	168	76	228	240	44	44	171	89	62	82
	3	1	1 1/4	---	---	527	543	165	---	168	76	228	240	44	44	171	89	62	82
	5	1	1 1/4	---	---	524	540	165	---	168	76	228	240	44	44	171	89	62	82

A strainer, approximately 20 mesh, should be installed on the suction side of the pump to prevent chips, scale or hard foreign particales from entering the pump and damaging the raceway and impeller.

Close Coupled Regenerative Turbine

1725 RPM

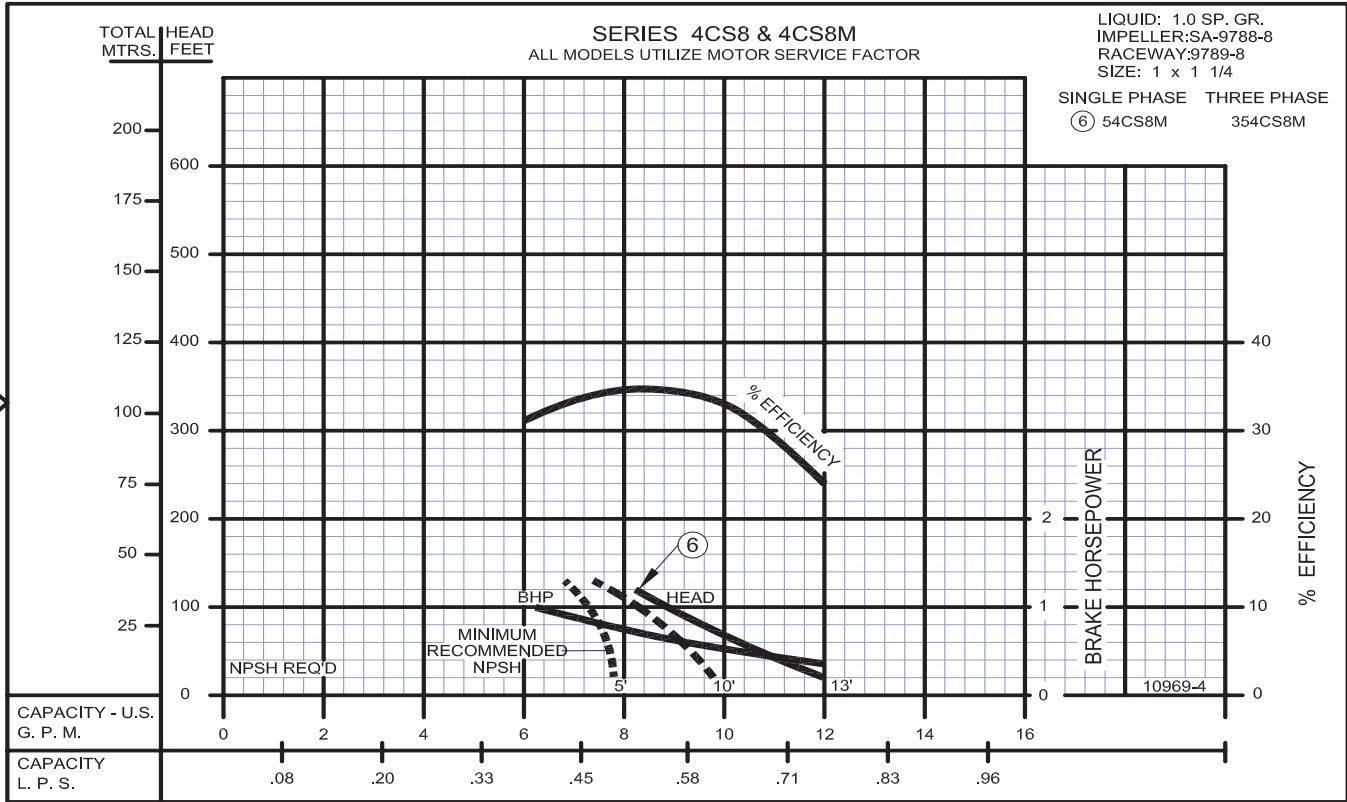

3450 RPM

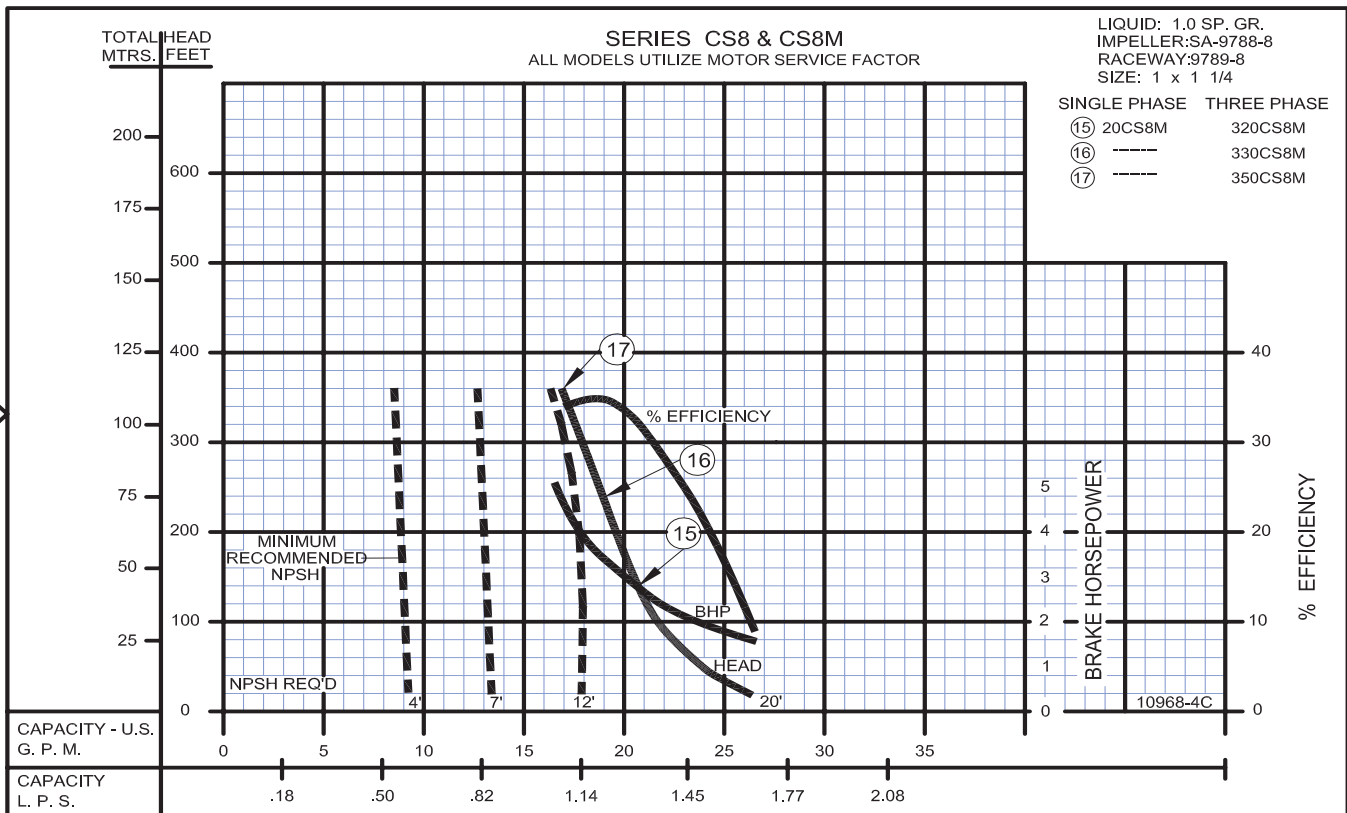

SECTION 7
PAGE 26
DATE 1/06



A Crane Co. Company

PUMPS & SYSTEMS

PumpAgents.com
Wholesale Pump Agents

USA: (937) 778-8947 • Canada: (905) 457-6223 • International: (937) 615-3598

Close Coupled Regenerative Turbine

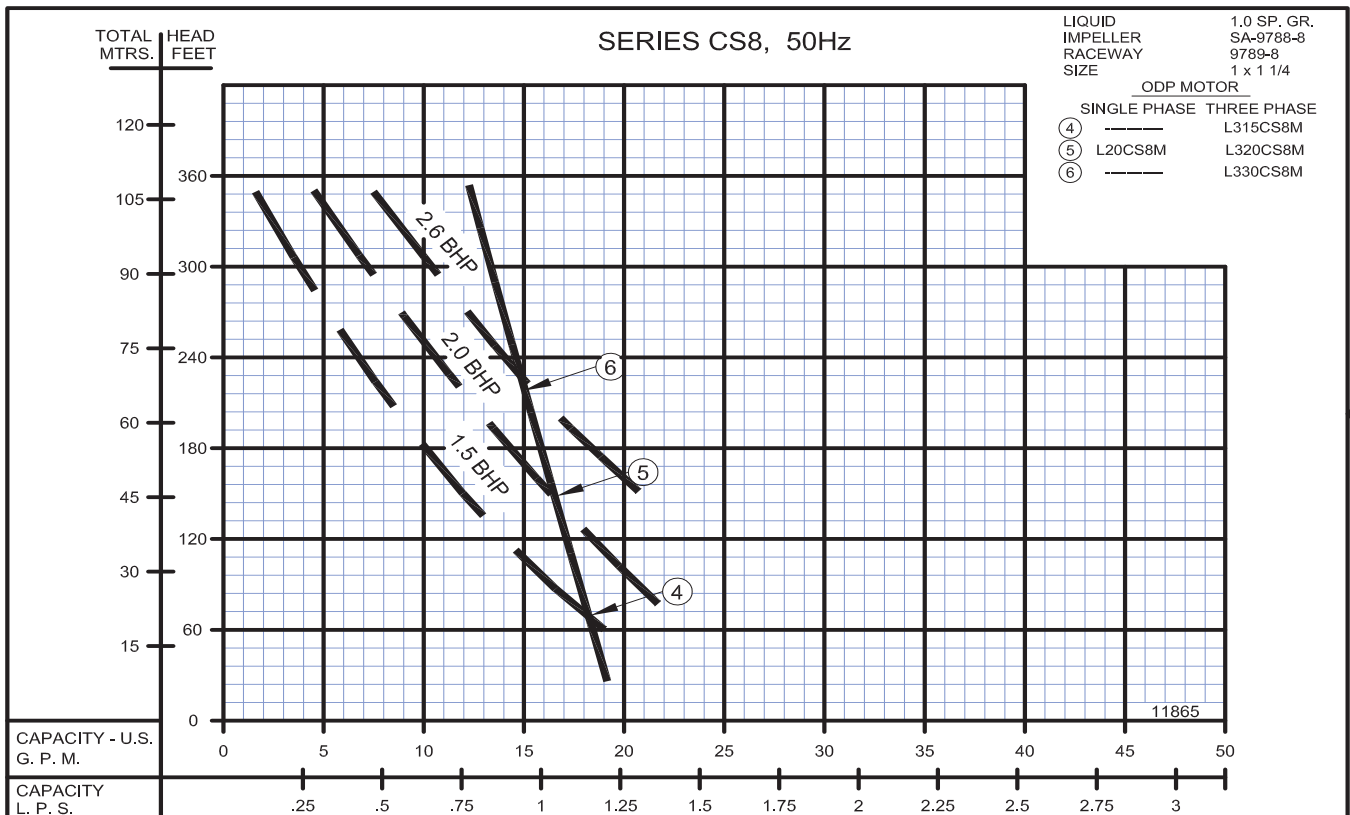
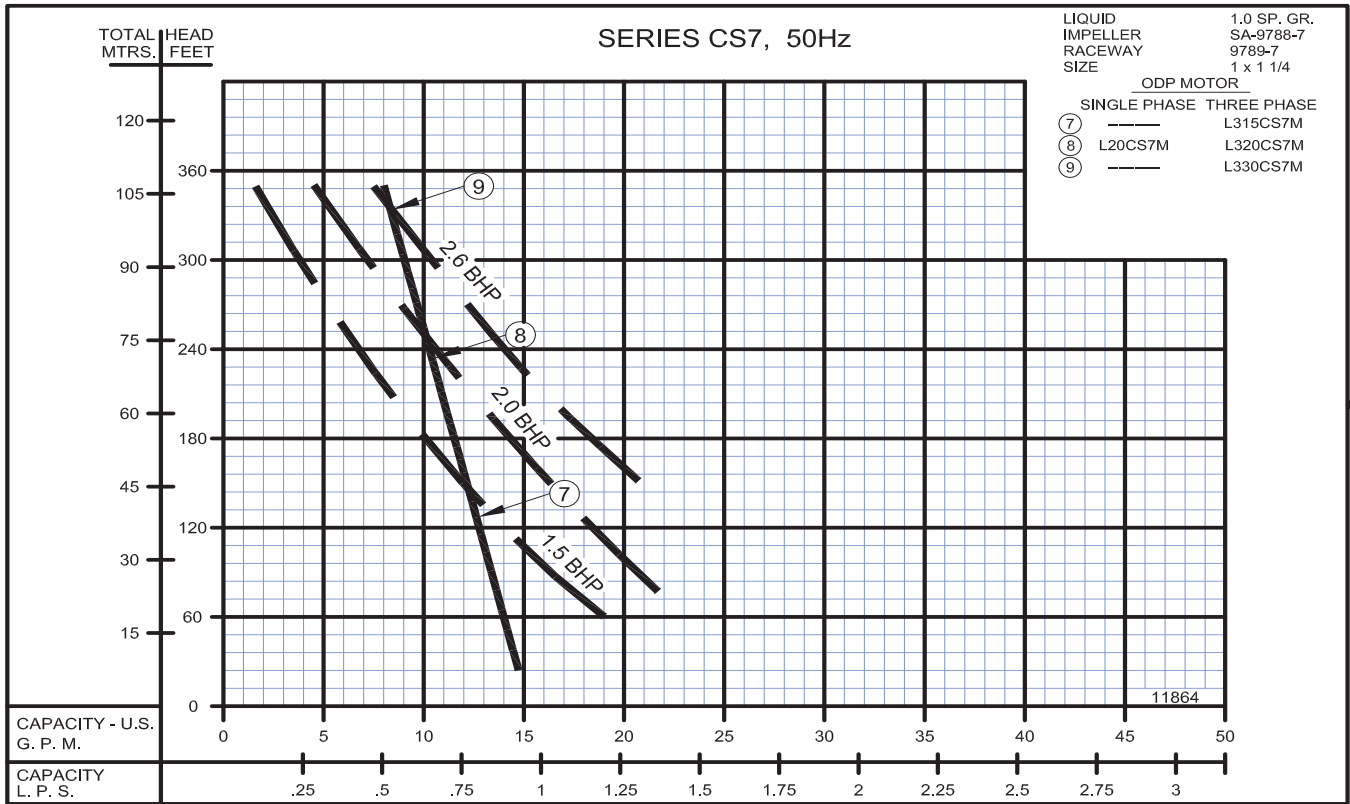

Turbines - Close Coupled

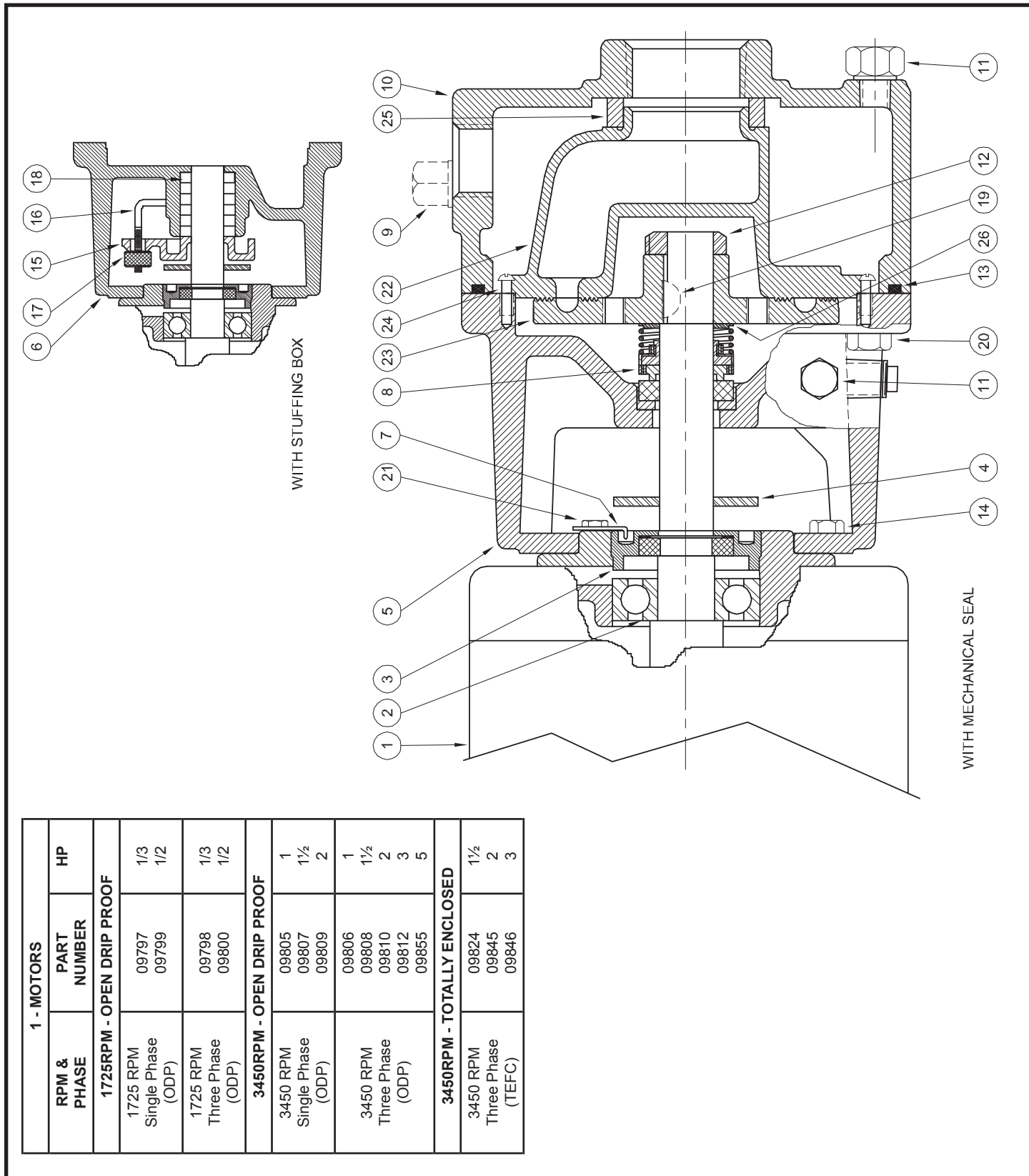

1 - MOTORS		HP
RPM & PHASE	PART NUMBER	
1725RPM - OPEN DRIP PROOF		
1725 RPM Single Phase (ODP)	09797 09799	1/3 1/2
1725 RPM Three Phase (ODP)	09798 09800	1/3 1/2
3450RPM - OPEN DRIP PROOF		
3450 RPM Single Phase (ODP)	09805 09807 09809	1 1½ 2
3450 RPM Three Phase (ODP)	09806 09808 09810 09812 09855	1 1½ 2 3 5
3450RPM - TOTALLY ENCLOSED		
3450 RPM Three Phase (TEFC)	09824 09845 09846	1½ 2 3

Turbines - Close Coupled

SYMBOL NUMBER	PART NUMBER	QTY	DESCRIPTION	
22	09789-5	1	Raceway for CS5M	
	09789-5-A	1	Raceway for CS5M	
	09789-6	1	Raceway for CS6M	
	09789-7	1	Raceway for CS7M	
	09789-8	1	Raceway for CS8M	
	09789-9	1	Raceway for CS9M	
	09789-9-A	1	Raceway for CS9M	
	* 23	SA09788-5	1	Impeller for CS5M
		SA09788-5-A	1	Impeller for CS5M
SA09788-6		1	Impeller for CS6M	
SA09788-7		1	Impeller for CS7M	
SA09788-HT-8		1	Impeller for CS8M	
SA09788-HT-9		1	Impeller for CS9M	
24	02535	2	Screw, Raceway to Frame	
	04231	1	Suction Sleeve - Buna-N (Std)	
	09695	1	Suction Sleeve - Viton	
	20285	1	Suction Sleeve - EPT	
	7441-A	1	Back-up Washer for CS5M ONLY	
DIFFERING PARTS FOR ALL BRONZE CONSTRUCTION				
5	09787-A	1	Frame (for mechanical seal)	
6	09792-A	1	Frame (for stuffing box)	
10	09790-C	1	Case	
14	09790-E	1	Case	
20	03121-B	4	Screw, 1/4-20 x 3/4" Lg	
	08771	4	Screw, 7/16-14 x 1/4" Lg - SS	

(* Standard impellers are suitable for fluid temperatures to 250°F (121°C). For higher temperatures, add the designation "HT" to impeller part number.

This includes all "MJ" Jacketed Seal Pumps. EXAMPLE: SA09788-HT-5

NOTE 1: Impeller and raceway must be ordered as a repair kit.
NOT available individually.

SYMBOL NUMBER	PART NUMBER	QTY	DESCRIPTION
2	09144	1	Ball Bearing - Pump End
3	05290	1	Ball Bearing - Switch End (Not Shown)
4	04206-A	1	Screw, Impeller Adjusting
5	08324	1	Slinger Washer
6	09787	1	Frame (for mechanical seal)
7	09787-C	1	Frame (for mechanical seal)
8	09792	1	Frame (for stuffing box)
9	07576	1	Adjusting Screw Lock
10	07576-S	1	Adjusting Screw Lock
11	08991	1	Mechanical Seal - Buna-N
12	09813-C	1	Mechanical Seal - Viton
13	21934	1	Mechanical Seal - EPT
14	02953	1	Plug, 1/2"
15	02953-B	1	Plug, 1/2"
16	09790-B	1	Case
17	09790-E	1	Case
18	04236	3	Plug, 1/4-18 NPT
19	01404	1	Impeller Lock Nut
20	01404-A	1	Impeller Lock Nut
21	09791	1	O-Ring Gasket - Buna-N
22	09817	1	O-Ring Gasket - Viton
23	22135	1	O-Ring Gasket - EPT
24	22104	1	O-Ring Gasket - Teflon
25	03121	4	Screw, 1/4" x 3/4"
26	1-523-1	4	Screw, 1/4" x 3/4"
27	05812-B	1	Gland, Stuffing Box
28	07003	2	Gland Bolt
29	04211	2	Gland Nut
30	05468	5	Packing
31	01457	1	Key, Woodruff (As Shown - Repair Kits Only)
32	21748-A	1	Key, Square
33	01931	4	Screw, 7/16-14 x 1/2" Lg
34	1-149-1	4	Screw, 7/16-14 x 1/4" Lg
35	07577	1	Screw, #10 x 3/8" Lg

REPAIR KITS FOR CS SERIES PUMPS

REPAIR KIT PN (Std Buna-N)	MODEL	REPAIR KIT PN (Viton)	MODEL	REPAIR KIT PN (EPT)	MODEL	REPAIR KIT PN (High Temp)	MODEL	REPAIR KIT PN (High Temp with Cooling Jacket)	MODEL
20522-5	CS5M	20522-5-MV	CS5MV	20522-5-ME	CS5ME	20522-HT-5	CS5MV-HT	20522-5-MJ	CS5MJ
20522-6	CS6M	20522-6-MV	CS6MV	20522-6-ME	CS6ME	20522-HT-6	CS6MV-HT	20522-6-MJ	CS6MJ
20522-7	CS7M	20522-7-MV	CS7MV	20522-7-ME	CS7ME	20522-HT-7	CS7MV-HT	20522-7-MJ	CS7MJ
20522-8	CS8M	20522-8-MV	CS8MV	20522-8-ME	CS8ME	20522-HT-8	CS8MV-HT	20522-8-MJ	CS8MJ
20522-9	CS9M	20522-9-MV	CS9MV	20522-9-ME	CS9ME	20522-HT-9	CS9MV-HT	20522-9-MJ	CS9MJ

KIT INCLUDES: Impeller, Raceway and Screws, Shaft Seal, Suction Sleeve, Impeller Locknut and Key, and Instructions.

WARNING:
CANCER AND REPRODUCTIVE HARM -
WWW.P65WARNINGS.CA.GOV

