

Close Coupled Regenerative Turbine

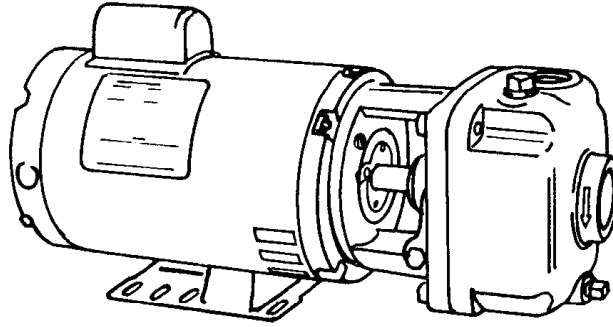

4CS - 1725 RPM - 60Hz.

CS - 3450 RPM - 60Hz.

(See Individual curves for symbol number)

| *MAXIMUM HEAD | | | |
|---------------|-------|----------------|-----------|
| Symbol Number | HP | Catalog Number | |
| | | 1 - Phase | 3 - Phase |
| 1 | 1/3 | 34CS5M | 334CS5M |
| 2 | 1/3 | 34CS6M | 334CS6M |
| 3 | 1/2 | 54CS6M | 354CS6M |
| 4 | 1/3 | 34CS7M | 334CS7M |
| 5 | 1/2 | 54CS7M | 354CS7M |
| 6 | 1/2 | 54CS8M | 354CS8M |
| 7 | 1 | 10CS5M | 310CS5M |
| 8 | 1 1/2 | 15CS5M | 315CS5M |
| 9 | 1 | 10CS6M | 310CS6M |
| 10 | 1 1/2 | 15CS6M | 315CS6M |
| 11 | 2 | 20CS6M | 320CS6M |
| 12 | 1 1/2 | 15CS7M | 315CS7M |
| 13 | 2 | 20CS7M | 320CS7M |
| 14 | 3 | ---- | 330CS7M |
| 15 | 2 | 20CS8M | 320CS8M |
| 16 | 3 | ---- | 330CS8M |
| 17 | 5 | ---- | 350CS8M |
| 18 | 3 | ---- | 330CS9M |
| 19 | 5 | ---- | 350CS9M |

(*) For Standard Pumps with ODP motors

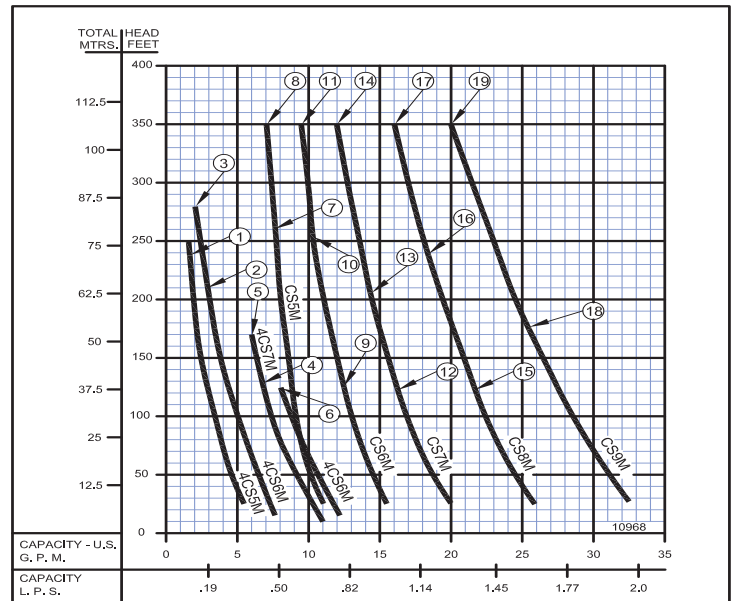

CS - 2900 RPM - 50Hz.

(See Individual curves for symbol number)

| MAXIMUM HEAD | | |
|---------------|-----|----------------|
| Symbol Number | HP | Catalog Number |
| * 1 | 2.0 | L320CS9M |
| 2 | 2.6 | L330CS9M |
| 3 | 4.0 | L340CS9M |
| 4 | 1.5 | L315CS8M |
| * 5 | 2.0 | L320CS8M |
| 6 | 2.6 | L330CS8M |
| 7 | 1.5 | L315CS7M |
| * 8 | 2.0 | L320CS7M |
| 9 | 2.6 | L330CS7M |
| 10 | 1.0 | L310CS6M |
| 11 | 1.5 | L315CS6M |
| * 12 | 2.0 | L320CS6M |
| 13 | 1.0 | L310CS5M |
| 14 | 1.0 | L315CS5M |

(*) Pump numbers 1, 5, 8 & 12 are the only pump available in single phase 115/230 volt. All of the pumps above are available with stuffing box.

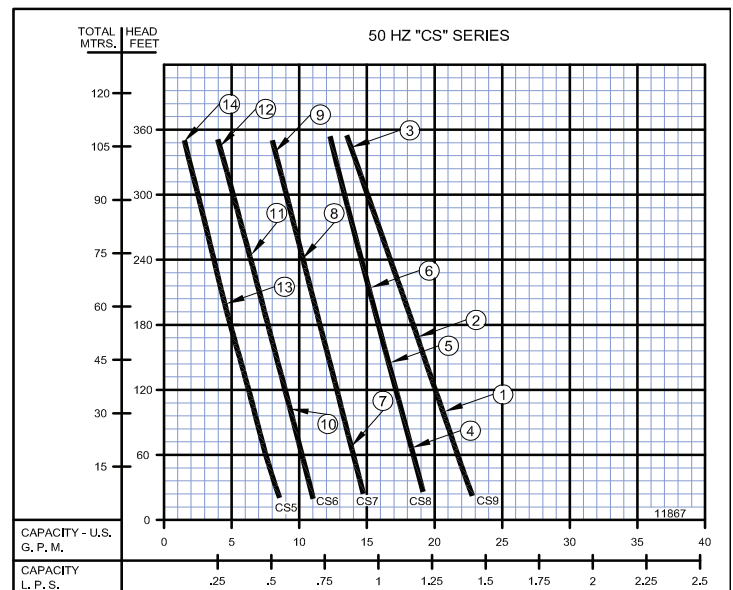

Close Coupled Regenerative Turbine

| 60 HZ - PERFORMANCE & SELECTION CHART | | | | | | | | | | | | | | | | | | | | |
|---------------------------------------|---------|-----------------|-----------|-----------|----------|------------|------------|----------|-------------|-------------|-------------|-------------|-------------|-------------|--------------|--------------|------------|--------------|--------------|--|
| Catalog Number | | HP | Tappings | | PSI Feet | TOTAL HEAD | | | | | | | | | | | | | | |
| | | | Suct. NPT | Disc. NPT | | 8.6 20 | 17.2 40 | 26 60 | 43.3 100 | 54.1 125 | 64.9 150 | 75.8 175 | 86.6 200 | 97.4 225 | 108.3 250 | 119.1 275 | 130 300 | 140.1 325 | 151.6 350 | |
| 1 Phase | 3 Phase | CAPACITY IN GPM | | | | | | | | | | | | | | | | | | |
| 1750 RPM | 34CS5M | 334CS5M | 1/3 | 1 1/4 | 1 | 5.8 | 4.9 | 4.3 | 3.3 | 2.8 | 2.4 | 2.1 | 1.8 | 1.6 | | | | | | |
| | 34CS6M | 334CS6M | 1/3 | | | 7.8 | 6.9 | 6.3 | 5.2 | 4.6 | 4.1 | 3.7 | 3.3 | | | | | | | |
| | 54CS6M | 354CS6M | 1/2 | | | 7.8 | 6.9 | 6.3 | 5.2 | 4.6 | 4.1 | 3.7 | 3.3 | 2.9 | 2.6 | 2.3 | | | | |
| | 34CS7M | 334CS7M | 1/3 | | | 10.4 | 9.4 | 8.5 | 7.2 | 6.5 | 5.9 | 5.4 | | | | | | | | |
| | 54CS7M | 354CS7M | 1/2 | | | 10.4 | 9.4 | 8.5 | 7.2 | 6.5 | 5.9 | 5.4 | | | | | | | | |
| | 54CS8M | 354CS8M | 1/2 | | | 12.2 | 11.3 | 10.4 | 9.0 | 8.2 | | | | | | | | | | |
| 3450 RPM | 10CS5M | 310CS5M | 1 | 1 1/4 | 1 | 11 | 10.6 | 10.1 | 9.3 | 9 | 8.5 | 8.2 | 8 | 7.7 | | | | | | |
| | 15CS5M | 315CS5M | 1 1/2 | | | 11 | 10.6 | 10.1 | 9.3 | 9 | 8.5 | 8.2 | 8 | 7.7 | 7.5 | 7.4 | 7.2 | 7.1 | | |
| | 10CS6M | 310CS6M | 1 | | | 16 | 15.2 | 14.5 | 13.5 | 12.8 | | | | | | | | | | |
| | 15CS6M | 315CS6M | 1 1/2 | | | 16 | 15.2 | 14.5 | 13.5 | 12.8 | 12.4 | 12 | 11.5 | 11 | 10.7 | | | | | |
| | 20CS6M | 320CS6M | 2 | | | 16 | 15.2 | 14.5 | 13.5 | 12.8 | 12.4 | 12 | 11.5 | 11 | 10.7 | 10.5 | 10.1 | 9.7 | 9.5* | |
| | 15CS7M | 315CS7M | 1 1/2 | | | 20.5 | 19.6 | 19.5 | 17.3 | | | | | | | | | | | |
| | 20CS7M | 320CS7M | 2 | | | 20.5 | 19.6 | 19.5 | 17.3 | 16.5 | 16 | 15.3 | 14.7 | | | | | | | |
| | | 330CS7M | 3 | | | 20.5 | 19.6 | 19.5 | 17.3 | 16.5 | 16 | 15.3 | 14.7 | 14.2 | 13.7 | 13.3 | 12.8 | 12.5 | 12* | |
| | 20CS8M | 320CS8M | 2 | | | 26.5 | 25.5 | 24.6 | 23 | 22 | | | | | | | | | | |
| | | 330CS8M | 3 | | | 26.5 | 25.5 | 24.6 | 23 | 22 | 21.3 | 20.5 | 19.8 | 19.2 | | | | | | |
| | 350CS8M | 5 | 26.5 | 25.5 | 24.6 | 23 | 22 | 21.3 | 20.5 | 19.8 | 19.2 | 18.5 | 18 | 17.4 | 16.8 | 16.3* | | | | |
| | 330CS9M | 3 | 32.5 | 31.5 | 30.5 | 28.6 | 27.5 | 26.5 | | | | | | | | | | | | |
| | 350CS9M | 5 | 32.5 | 31.5 | 30.5 | 28.6 | 27.5 | 26.5 | 25.6 | 24.7 | 23.8 | 23 | 22.2 | 21.5 | 20.7 | 20* | | | | |

* Rated to 358 ft (155 psi) per performance curve.

| 60 HZ - PERFORMANCE & SELECTION CHART | | | | | | | | | | | | | | | | | | | | |
|---------------------------------------|---------|-----------------|----------------|----------------|------------|------------|-------------|-------------|-------------|-------------|-------------|-------------|-----------|-------------|-------------|-------------|-------------|-------------|---------------|--|
| Catalog Number | | HP | Tappings | | kPa Meters | TOTAL HEAD | | | | | | | | | | | | | | |
| | | | Suct. NPT (in) | Disc. NPT (in) | | 59 6.1 | 119 12.1 | 179 18.2 | 299 30.5 | 373 38.1 | 447 45.7 | 523 53.3 | 597 61 | 672 68.6 | 747 76.2 | 821 83.8 | 896 91.4 | 966 99.1 | 1045 106.6 | |
| 1 Phase | 3 Phase | CAPACITY IN LPS | | | | | | | | | | | | | | | | | | |
| 1750 RPM | 34CS5M | 334CS5M | 1/3 | 1 1/4 | 1 | 0.36 | 0.30 | 0.27 | 0.20 | 0.17 | 0.15 | 0.13 | 0.11 | 1.6 | | | | | | |
| | 34CS6M | 334CS6M | 1/3 | | | 0.49 | 0.43 | 0.39 | 0.32 | 0.29 | 0.25 | 0.23 | 0.20 | | | | | | | |
| | 54CS6M | 354CS6M | 1/2 | | | 0.49 | 0.43 | 0.39 | 0.32 | 0.29 | 0.25 | 0.23 | 0.20 | 0.18 | 0.16 | 0.14 | | | | |
| | 34CS7M | 334CS7M | 1/3 | | | 0.65 | 0.59 | 0.53 | 0.45 | 0.41 | | | | | | | | | | |
| | 54CS7M | 354CS7M | 1/2 | | | 0.65 | 0.59 | 0.53 | 0.45 | 0.41 | 0.37 | 0.34 | | | | | | | | |
| | 54CS8M | 354CS8M | 1/2 | | | 0.76 | 0.71 | 0.65 | 0.56 | 0.51 | | | | | | | | | | |
| 3450 RPM | 10CS5M | 310CS5M | 1 | 1 1/4 | 1 | 0.69 | 0.66 | 0.63 | 0.58 | 0.56 | 0.53 | 0.51 | 0.50 | 0.48 | | | | | | |
| | 15CS5M | 315CS5M | 1 1/2 | | | 0.69 | 0.66 | 0.63 | 0.58 | 0.56 | 0.53 | 0.51 | 0.50 | 0.48 | 0.47 | 0.46 | 0.45 | 0.44 | | |
| | 10CS6M | 310CS6M | 1 | | | 1.00 | 0.95 | 0.91 | 0.85 | 0.80 | | | | | | | | | | |
| | 15CS6M | 315CS6M | 1 1/2 | | | 1.00 | 0.95 | 0.91 | 0.85 | 0.80 | 0.78 | 0.75 | 0.72 | 0.69 | 0.67 | | | | | |
| | 20CS6M | 320CS6M | 2 | | | 1.00 | 0.95 | 0.91 | 0.85 | 0.80 | 0.78 | 0.75 | 0.72 | 0.69 | 0.67 | 0.66 | 0.63 | 0.61 | 0.59 | |
| | 15CS7M | 315CS7M | 1 1/2 | | | 1.29 | 1.24 | 1.23 | 1.09 | | | | | | | | | | | |
| | 20CS7M | 320CS7M | 2 | | | 1.29 | 1.24 | 1.23 | 1.09 | 1.04 | 1.00 | 0.96 | 0.92 | | | | | | | |
| | | 330CS7M | 3 | | | 1.29 | 1.24 | 1.23 | 1.09 | 1.04 | 1.00 | 0.96 | 0.92 | 0.89 | 0.86 | 0.83 | 0.80 | 0.78 | 0.75 | |
| | 20CS8M | 320CS8M | 2 | | | 1.67 | 1.60 | 1.55 | 1.45 | 1.38 | | | | | | | | | | |
| | | 330CS8M | 3 | | | 1.67 | 1.60 | 1.55 | 1.45 | 1.38 | 1.34 | 1.29 | 1.24 | 1.21 | | | | | | |
| | 350CS8M | 5 | 1.67 | 1.60 | 1.55 | 1.45 | 1.38 | 1.34 | 1.29 | 1.24 | 1.21 | 1.16 | 1.13 | 1.09 | 1.05 | 1.02 | | | | |
| | 330CS9M | 3 | 2.05 | 1.98 | 1.92 | 1.80 | 1.73 | 1.67 | | | | | | | | | | | | |
| | 350CS9M | 5 | 2.05 | 1.98 | 1.92 | 1.80 | 1.73 | 1.67 | 1.61 | 1.55 | 1.50 | 1.45 | 1.40 | 1.35 | 1.30 | 1.26 | | | | |

NOTE: When pumping hot water over 180°F (82.2°C), check the NPSH available in the pumping system against the required pump NPSH shown on pump performance curves. Available NPSH must be greater than required NPSH.

Close Coupled Regenerative Turbine

| 50 HZ - PERFORMANCE & SELECTION CHART | | | | | | | | | | | | | | | | | | | | | |
|---------------------------------------|----------|-----|-----------|-----------|----------|------------|------|------|------|------|------|------|------|------|-------|-------|------|-------|-------|------|-------|
| Catalog Number | | HP | Tappings | | PSI Feet | TOTAL HEAD | | | | | | | | | | | | | | | |
| | | | Suct. NPT | Disc. NPT | | 8.6 | 17.2 | 26 | 43.3 | 54.1 | 64.9 | 75.8 | 86.6 | 97.4 | 108.3 | 119.1 | 130 | 140.1 | 151.6 | | |
| 1 Phase | 3 Phase | | | | 20 | 40 | 60 | 100 | 125 | 150 | 175 | 200 | 225 | 250 | 275 | 300 | 325 | 350 | | | |
| CAPACITY IN GPM | | | | | | | | | | | | | | | | | | | | | |
| | L310CS5M | 1 | 1 1/4 | 1 | | 8.5 | 8.0 | 7.5 | 6.5 | 6.0 | 5.5 | 5.0 | 4.5 | 4.0 | 3.5 | 3.0 | 2.5 | 2.0 | 1.5* | | |
| | L315CS5M | 1.5 | | | | | | 8.5 | 8.0 | 7.5 | 6.5 | 6.0 | 5.5 | 5.0 | 4.5 | 4.0 | 3.5 | 3.0 | 2.5 | 2.0 | 1.5* |
| | L310CS6M | 1 | | | | | | 11.0 | 10.5 | 10.0 | 9.3 | 9.0 | 8.3 | 7.8 | 7.3 | 6.8 | 6.3 | | | | |
| | L315CS6M | 1.5 | | | | | | 11.0 | 10.5 | 10.0 | 9.3 | 9.0 | 8.3 | 7.8 | 7.3 | 6.8 | 6.3 | | | | |
| L20CS6M | L320CS6M | 2 | | | | | | 11.0 | 10.5 | 10.0 | 9.3 | 9.0 | 8.3 | 7.8 | 7.3 | 6.8 | 6.3 | 5.8 | 5.0 | 4.5 | 4.0* |
| | L315CS7M | 1.5 | | | | | | 14.8 | 14.3 | 14.0 | 13.0 | 12.8 | | | | | | | | | |
| | L330CS7M | 2.6 | | | | | | 14.8 | 14.3 | 14.0 | 13.0 | 12.8 | 12.0 | 11.6 | 11.0 | 10.5 | 10.0 | 9.5 | 9.0 | 8.5 | 8.0* |
| L20CS7M | L320CS7M | 2 | | | | | | 14.8 | 14.3 | 14.0 | 13.0 | 12.8 | 12.0 | 11.6 | 11.0 | 10.5 | | | | | |
| | L315CS8M | 1.5 | | | | | | 19.0 | 18.8 | 18.3 | | | | | | | | | | | |
| | L330CS8M | 2.6 | | | | | | 19.0 | 18.8 | 18.3 | 17.5 | 17.0 | 16.5 | 16.0 | 15.5 | 15.0 | 14.5 | 14.0 | 13.3 | 13.0 | 12.3* |
| L20CS8M | L320CS8M | 2 | | | | | | 19.0 | 18.8 | 18.3 | 17.5 | 17.0 | 16.5 | | | | | | | | |
| L20CS9M | L320CS9M | 2 | | | | | | 22.8 | 22.3 | 21.8 | 20.5 | | | | | | | | | | |
| ---- | L330CS9M | 2.6 | | | | | | 22.8 | 22.3 | 21.8 | 20.5 | 20.0 | 19.3 | 18.8 | | | | | | | |
| ---- | L340CS9M | 4.0 | | | | | | 22.8 | 22.3 | 21.8 | 20.5 | 20.0 | 19.3 | 18.8 | 18.0 | 17.0 | 16.5 | 15.8 | 15.0 | 14.3 | 13.5* |

2900 RPM

* Rated to 358 ft (155 psi) per performance curve.

| 50 HZ - PERFORMANCE & SELECTION CHART | | | | | | | | | | | | | | | | | | | | | |
|---------------------------------------|----------|-----|----------------|----------------|------------|------------|------|------|------|------|------|------|------|------|------|------|------|-------|------|------|------|
| Catalog Number | | HP | Tappings | | kPa Meters | TOTAL HEAD | | | | | | | | | | | | | | | |
| | | | Suct. NPT (in) | Disc. NPT (in) | | 59 | 119 | 179 | 299 | 373 | 447 | 523 | 597 | 672 | 747 | 821 | 896 | 966 | 1045 | | |
| 1 Phase | 3 Phase | | | | 6.1 | 12.1 | 18.2 | 30.5 | 38.1 | 45.7 | 53.3 | 61 | 68.6 | 76.2 | 83.8 | 91.4 | 99.1 | 106.6 | | | |
| CAPACITY IN LPS | | | | | | | | | | | | | | | | | | | | | |
| | L310CS5M | 1 | 1 1/4 | 1 | | 0.54 | 0.50 | 0.47 | 0.41 | 0.38 | 0.35 | 0.32 | 0.28 | 0.25 | 0.22 | 0.19 | 0.16 | 0.13 | 0.09 | | |
| | L315CS5M | 1.5 | | | | | | 0.54 | 0.50 | 0.47 | 0.41 | 0.38 | 0.35 | 0.32 | 0.28 | 0.25 | 0.22 | 0.19 | 0.16 | 0.13 | 0.09 |
| | L310CS6M | 1 | | | | | | 0.69 | 0.66 | 0.63 | 0.58 | 0.56 | 0.52 | 0.49 | 0.46 | 0.42 | 0.39 | | | | |
| | L315CS6M | 1.5 | | | | | | 0.69 | 0.66 | 0.63 | 0.58 | 0.56 | 0.52 | 0.49 | 0.46 | 0.42 | 0.39 | | | | |
| L20CS6M | L320CS6M | 2 | | | | | | 0.69 | 0.66 | 0.63 | 0.58 | 0.56 | 0.52 | 0.49 | 0.46 | 0.42 | 0.39 | 0.36 | 0.31 | 0.28 | 0.25 |
| | L315CS7M | 1.5 | | | | | | 0.93 | 0.90 | 0.88 | 0.82 | 0.80 | | | | | | | | | |
| | L330CS7M | 2.6 | | | | | | 0.93 | 0.90 | 0.88 | 0.82 | 0.80 | 0.75 | 0.73 | 0.69 | 0.66 | 0.63 | 0.59 | 0.56 | 0.53 | 0.50 |
| L20CS7M | L320CS7M | 2 | | | | | | 0.93 | 0.90 | 0.88 | 0.82 | 0.80 | 0.75 | 0.73 | 0.69 | 0.66 | | | | | |
| | L315CS8M | 1.5 | | | | | | 1.19 | 1.18 | 1.15 | | | | | | | | | | | |
| | L330CS8M | 2.6 | | | | | | 1.19 | 1.18 | 1.15 | 1.10 | 1.07 | 1.04 | 1.00 | 0.97 | 0.94 | 0.91 | 0.88 | 0.83 | 0.82 | 0.77 |
| L20CS8M | L320CS8M | 2 | | | | | | 1.19 | 1.18 | 1.15 | 1.10 | 1.07 | 1.04 | | | | | | | | |
| L20CS9M | L320CS9M | 2 | | | | | | 1.43 | 1.40 | 1.37 | 1.29 | | | | | | | | | | |
| | L330CS9M | 2.6 | | | | | | 1.43 | 1.40 | 1.37 | 1.29 | 1.26 | 1.21 | 1.18 | | | | | | | |
| | L340CS9M | 4.0 | | | | | | 1.43 | 1.40 | 1.37 | 1.29 | 1.26 | 1.21 | 1.18 | 1.13 | 1.07 | 1.04 | 0.99 | 0.94 | 0.90 | 0.85 |

2900 RPM

NOTE: When pumping hot water over 180°F (82.2°C), check the NPSH available in the pumping system against the required pump NPSH shown on pump performance curves. Available NPSH must be greater than required NPSH.

Close Coupled Regenerative Turbine



BURKS exclusive unique regenerative type turbine pumps are designed to handle clear water and many other non-abrasive, lower viscosity liquids on high pressure, low capacity applications with the greatest possible efficiency.

BURKS is the only turbine pump with Life-Lok® External Impeller Adjustment feature that allows readjustment of impeller without disturbing piping, disassembling pump or replacing parts. Gives up to 40% longer service life than turbine pumps of other designs.

- Self-Priming
- Compact, Space-saving size
- No coupling - eliminates misalignment problems
- Dependable carbon/ceramic mechanical shaft seal for temperatures to 225°F (107°C).
- Bronze impeller with Monel blades - the only moving part
- Bronze raceway with cast-in vortex pockets - will not vapor lock
- #303 Stainless Steel pump shaft
- Easy to service
- Every pump factory tested
- Available Bronze fitted, All Bronze, Stainless Steel

**WARNING:**

CANCER AND REPRODUCTIVE HARM -
WWW.P65WARNINGS.CA.GOV

| MAXIMUM OPERATING CONDITIONS | |
|---|-------------------|
| TEMPERATURE (For Standard Buna-N Seal) | 225°F (107°C) |
| INLET PRESSURE | 100 PSI (689kPa) |
| CASING WORKING PRESSURE | 250 PSI (1723kPa) |

MOTOR INFORMATION**4CS Series:**

Single Phase motors are 115/208-230 Volt, 60Hz, 1750RPM

Three Phase motors are 208-230/460 Volts, 60/50Hz, 1750/1450RPM

CS Series:

Single Phase motors are 115/208-230 Volt, 60 Hz, 3450RPM

Three Phase 1, 1 1/2 & 2HP. - 208-230/460 Volt, 60/50 Hz., 3450/2900 RPM

Three Phase 3 & 5 HP - 208-230/460 Volt, 60 Hz, 3450RPM

Standard pump motors have open drip proof construction and are rated with jet pump service factors for continuous duty operation at all ratings shown.

Single phase motors are capacitor start/induction run with built-in overload protection.

Three phase motors require a magnetic type starter which provides full 3-leg overload protection. Failure to use the correct starter and overloads will void the warranty.

FOR TEMPERATURES TO 500°F (260°C).

Series CS Pumps are available in a Jacketed Seal Cavity design for pumping hot oil, hot water and heat transfer fluids in common use in high temperature heating or cooling applications. This feature greatly extends seal life in high temperature applications. To order, add suffix "J" to pump catalog number for temperatures below 400°F (204°C) and add suffix "JK" to pump catalog number for temperatures over 400°F (204°C). Example: 15CS5MJ. See Section on High Temperature Pumps for more information.

| MATERIALS OF CONSTRUCTION | | | |
|---------------------------|-------------------------------|-------------------------------|-------------------------------|
| PART | BRONZE FITTED | ALL BRONZE | STAINLESS STEEL |
| Frame | Cast Iron | Bronze | #316 Stainless |
| Case | Cast Iron | Bronze | #316 Stainless |
| Impeller | Bronze (Monel Blades) | Bronze (Monel Blades) | #303 Stainless |
| Raceway | Bronze | Bronze | #303 Stainless |
| Shaft | #303 Stainless | #303 Stainless | #303 Stainless |
| Shaft Seal | Carbon-Ceramic SS - Buna-N | Carbon-Ceramic SS - Buna-N | Carbon-Ceramic SS - Buna-N |

Close Coupled Regenerative Turbine

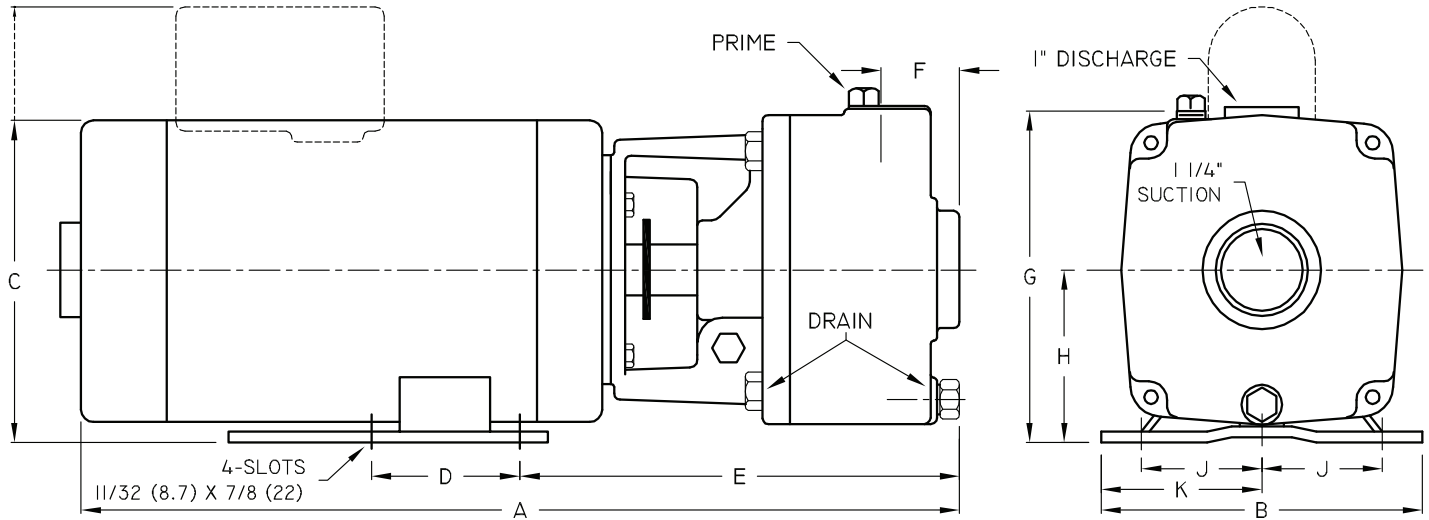

DIMENSIONS IN INCHES - ODP

| Series | HP | Tappings | | 1 PH A | 1 PH A (S.S.) | 3 PH A | 3 PH A (S.S.) | B | 1 PH C | 3 PH C | D | E | E (S.S.) | F | F (S.S.) | G | H | J | K |
|--------|-------|----------------------|----------------------|-----------|---------------------|-----------|---------------------|-------|-----------|-----------|---|---|-------------|-------|-------------|-------|-------|--------|-------|
| | | Disc. NPT (in) | Suct. NPT (in) | | | | | | | | | | | | | | | | |
| 4CS | 1/3 | 1 | 1 1/4 | 17 5/8 | 18 1/16 | 16 3/8 | 16 13/16 | 6 1/2 | 6 5/8 | 6 5/8 | 3 | 9 | 9 7/16 | 1 3/4 | 1 3/4 | 6 3/4 | 3 1/2 | 2 7/16 | 3 1/4 |
| | 1/2 | 1 | 1 1/4 | 17 5/8 | 18 1/16 | 16 5/8 | 16 13/16 | 6 1/2 | 6 5/8 | 6 5/8 | 3 | 9 | 9 7/16 | 1 3/4 | 1 3/4 | 6 3/4 | 3 1/2 | 2 7/16 | 3 1/4 |
| CS | 1 | 1 | 1 1/4 | 18 5/16 | 18 3/4 | 18 5/16 | 18 3/4 | 6 1/2 | 6 5/8 | 6 5/8 | 3 | 9 | 9 7/16 | 1 3/4 | 1 3/4 | 6 3/4 | 3 1/2 | 2 7/16 | 3 1/4 |
| | 1 1/2 | 1 | 1 1/4 | 19 1/16 | 19 1/2 | 19 1/16 | 19 1/2 | 6 1/2 | 8 13/16 | 6 5/8 | 3 | 9 | 9 7/16 | 1 3/4 | 1 3/4 | 6 3/4 | 3 1/2 | 2 7/16 | 3 1/4 |
| | 2 | 1 | 1 1/4 | 19 9/16 | 20 | 19 1/16 | 19 1/2 | 6 1/2 | 8 13/16 | 6 5/8 | 3 | 9 | 9 7/16 | 1 3/4 | 1 3/4 | 6 3/4 | 3 1/2 | 2 7/16 | 3 1/4 |
| | 3 | 1 | 1 1/4 | --- | --- | 19 9/16 | 20 | 6 1/2 | --- | 6 5/8 | 3 | 9 | 9 7/16 | 1 3/4 | 1 3/4 | 6 3/4 | 3 1/2 | 2 7/16 | 3 1/4 |
| | 5 | 1 | 1 1/4 | --- | --- | 20 15/16 | 21 3/8 | 6 1/2 | --- | 6 5/8 | 3 | 9 | 9 7/16 | 1 3/4 | 1 3/4 | 6 3/4 | 3 1/2 | 2 7/16 | 3 1/4 |

DIMENSIONS IN INCHES - TEFC

| Series | HP | Tappings | | 1 PH A | 1 PH A (S.S.) | 3 PH A | 3 PH A (S.S.) | B | 1 PH C | 3 PH C | D | E | E (S.S.) | F | F (S.S.) | G | H | J | K |
|--------|-------|----------------------|----------------------|-----------|---------------------|-----------|---------------------|-------|-----------|-----------|---|---|-------------|-------|-------------|-------|-------|--------|-------|
| | | Disc. NPT (in) | Suct. NPT (in) | | | | | | | | | | | | | | | | |
| CS | 1 1/2 | 1 | 1 1/4 | --- | --- | 18 1/2 | 19 1/8 | 6 1/2 | --- | 6 5/8 | 3 | 9 | 9 7/16 | 1 3/4 | 1 3/4 | 6 3/4 | 3 1/2 | 2 7/16 | 3 1/4 |
| | 2 | 1 | 1 1/4 | --- | --- | 18 1/2 | 19 1/8 | 6 1/2 | --- | 6 5/8 | 3 | 9 | 9 7/16 | 1 3/4 | 1 3/4 | 6 3/4 | 3 1/2 | 2 7/16 | 3 1/4 |
| | 3 | 1 | 1 1/4 | --- | --- | 20 3/4 | 21 3/8 | 6 1/2 | --- | 6 5/8 | 3 | 9 | 9 7/16 | 1 3/4 | 1 3/4 | 6 3/4 | 3 1/2 | 2 7/16 | 3 1/4 |
| | 5 | 1 | 1 1/4 | --- | --- | 20 5/8 | 21 1/4 | 6 1/2 | --- | 6 5/8 | 3 | 9 | 9 7/16 | 1 3/4 | 1 3/4 | 6 3/4 | 3 1/2 | 2 7/16 | 3 1/4 |

A strainer, approximately 20 mesh, should be installed on the suction side of the pump to prevent chips, scale or hard foreign particales from entering the pump and damaging the raceway and impeller.

Close Coupled Regenerative Turbine

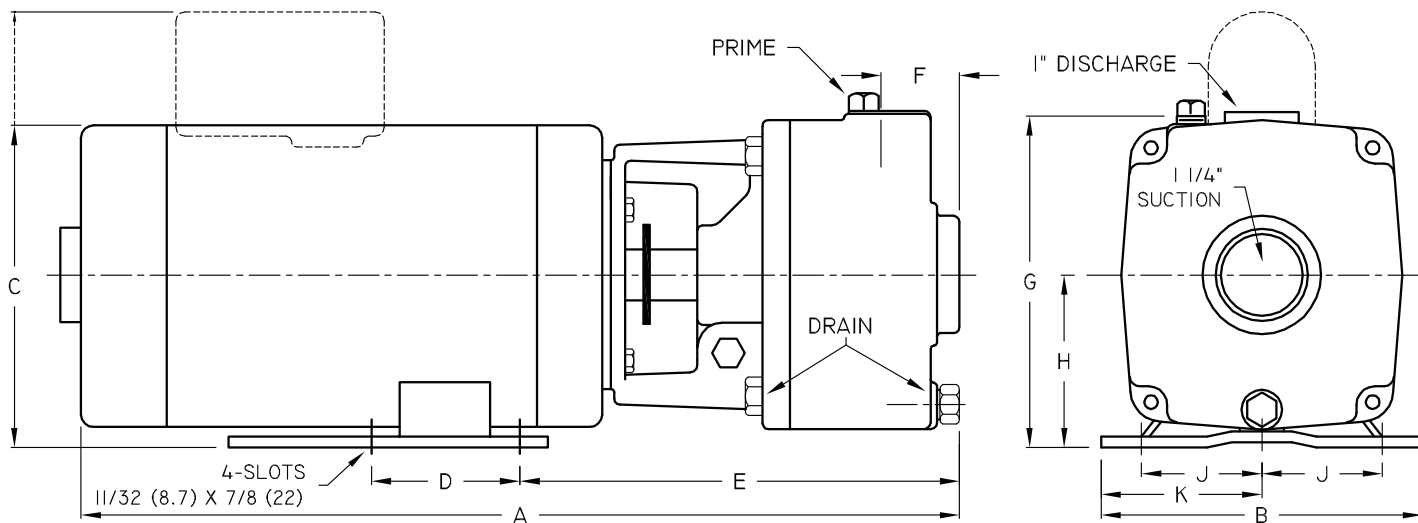

| Series | HP | Tappings | | DIMENSIONS IN MILLIMETERS - ODP | | | | | | | | | | | | | | | |
|--------|-------|----------------|----------------|---------------------------------|---------------|--------|---------------|-----|--------|--------|----|-----|----------|----|----------|-----|----|----|----|
| | | Disc. NPT (in) | Suct. NPT (in) | 1 PH A | 1 PH A (S.S.) | 3 PH A | 3 PH A (S.S.) | B | 1 PH C | 3 PH C | D | E | E (S.S.) | F | F (S.S.) | G | H | J | K |
| 4CS | 1/3 | 1 | 1 1/4 | 447 | 459 | 415 | 427 | 165 | 168 | 168 | 76 | 228 | 240 | 44 | 44 | 171 | 89 | 62 | 82 |
| | 1/2 | 1 | 1 1/4 | 447 | 459 | 422 | 427 | 165 | 168 | 168 | 76 | 228 | 240 | 44 | 44 | 171 | 89 | 62 | 82 |
| CS | 1 | 1 | 1 1/4 | 465 | 476 | 465 | 476 | 165 | 168 | 168 | 76 | 228 | 240 | 44 | 44 | 171 | 89 | 62 | 82 |
| | 1 1/2 | 1 | 1 1/4 | 484 | 495 | 484 | 495 | 165 | 223 | 168 | 76 | 228 | 240 | 44 | 44 | 171 | 89 | 62 | 82 |
| | 2 | 1 | 1 1/4 | 496 | 508 | 484 | 495 | 165 | 223 | 168 | 76 | 228 | 240 | 44 | 44 | 171 | 89 | 62 | 82 |
| | 3 | 1 | 1 1/4 | --- | --- | 496 | 508 | 165 | --- | 168 | 76 | 228 | 240 | 44 | 44 | 171 | 89 | 62 | 82 |
| | 5 | 1 | 1 1/4 | --- | --- | 531 | 543 | 165 | --- | 168 | 76 | 228 | 240 | 44 | 44 | 171 | 89 | 62 | 82 |

| Series | HP | Tappings | | DIMENSIONS IN MILLIMETERS - TEFC | | | | | | | | | | | | | | | |
|--------|-------|----------------|----------------|----------------------------------|---------------|--------|---------------|-----|--------|--------|----|-----|----------|----|----------|-----|----|----|----|
| | | Disc. NPT (in) | Suct. NPT (in) | 1 PH A | 1 PH A (S.S.) | 3 PH A | 3 PH A (S.S.) | B | 1 PH C | 3 PH C | D | E | E (S.S.) | F | F (S.S.) | G | H | J | K |
| CS | 1 1/2 | 1 | 1 1/4 | --- | --- | 470 | 486 | 165 | --- | 168 | 76 | 228 | 240 | 44 | 44 | 171 | 89 | 62 | 82 |
| | 2 | 1 | 1 1/4 | --- | --- | 470 | 486 | 165 | --- | 168 | 76 | 228 | 240 | 44 | 44 | 171 | 89 | 62 | 82 |
| | 3 | 1 | 1 1/4 | --- | --- | 527 | 543 | 165 | --- | 168 | 76 | 228 | 240 | 44 | 44 | 171 | 89 | 62 | 82 |
| | 5 | 1 | 1 1/4 | --- | --- | 524 | 540 | 165 | --- | 168 | 76 | 228 | 240 | 44 | 44 | 171 | 89 | 62 | 82 |

A strainer, approximately 20 mesh, should be installed on the suction side of the pump to prevent chips, scale or hard foreign particales from entering the pump and damaging the raceway and impeller.

Close Coupled Regenerative Turbine

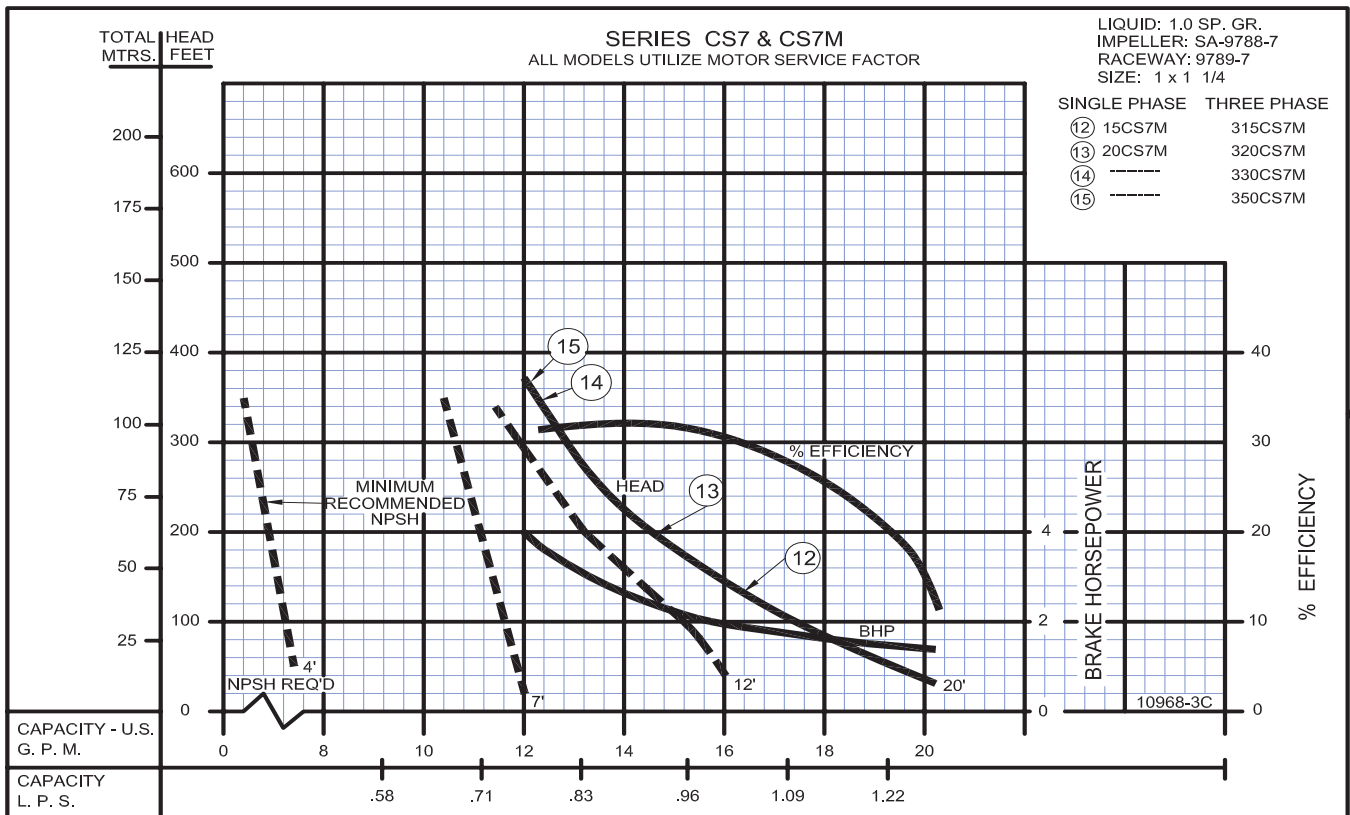
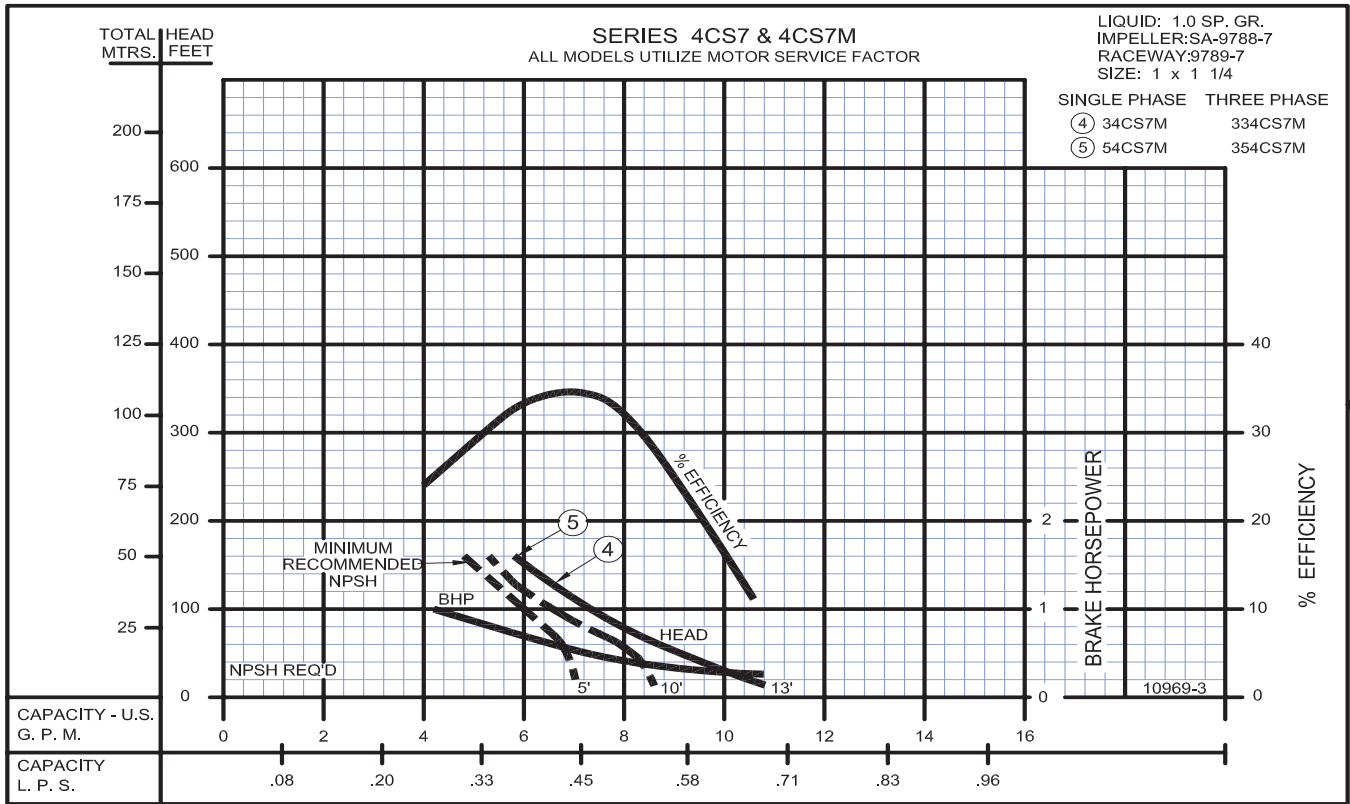

Close Coupled Regenerative Turbine

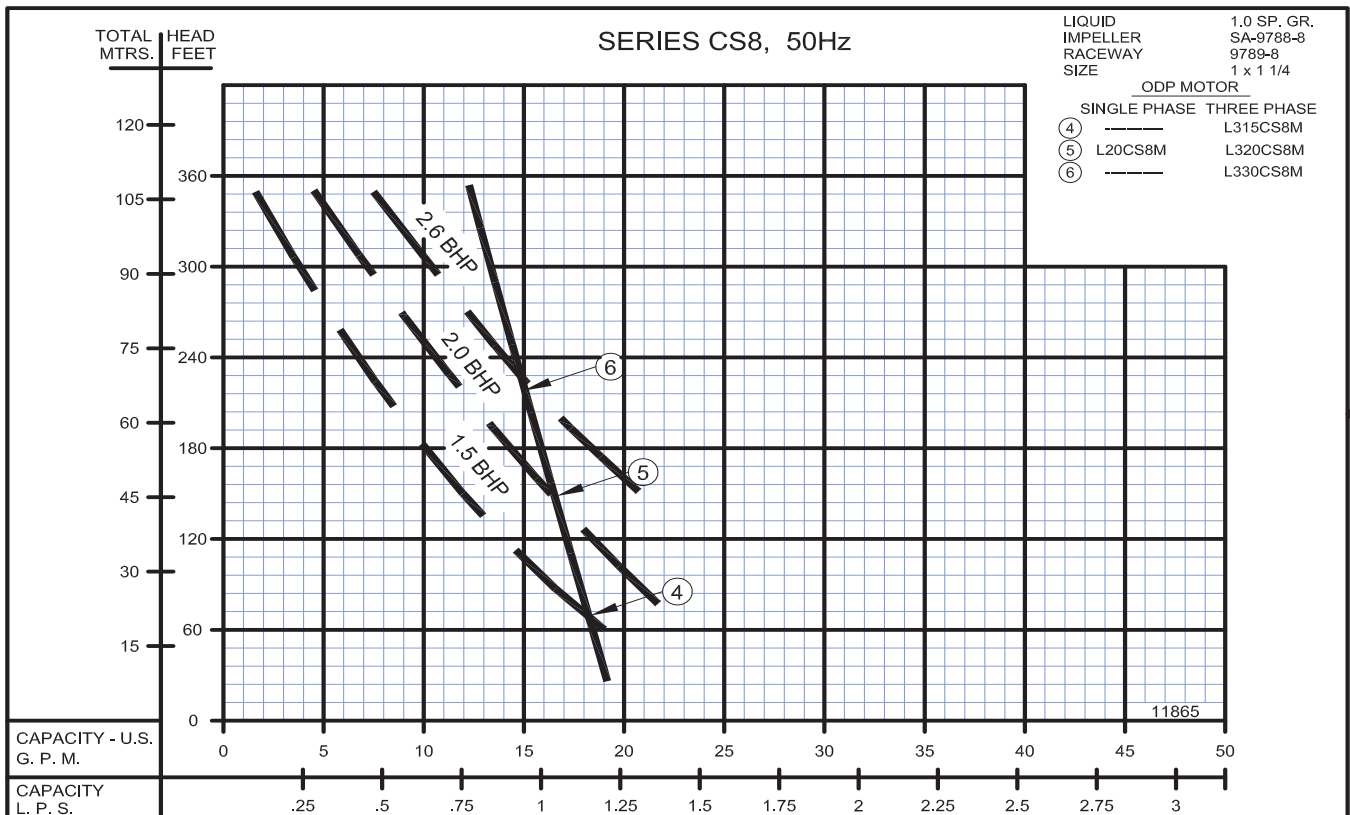
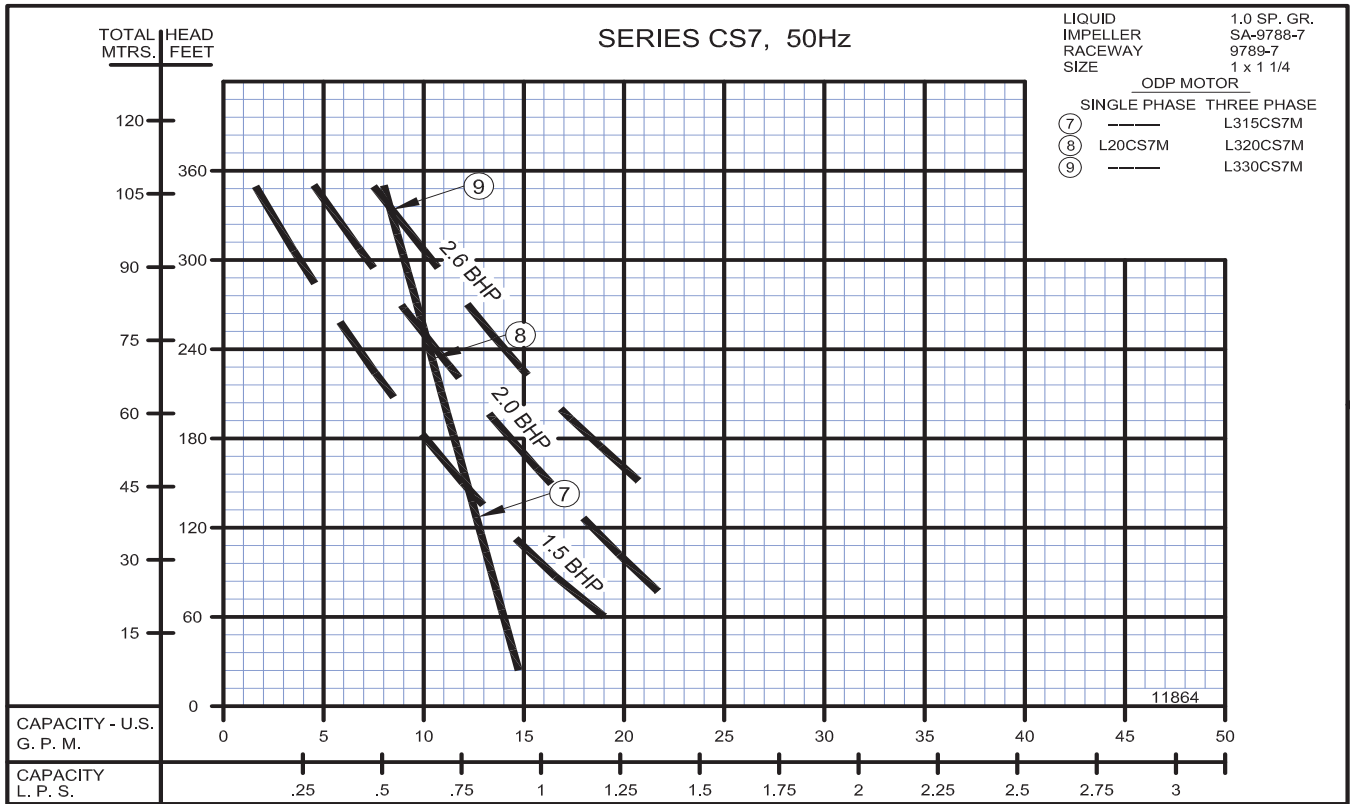

Turbines - Close Coupled

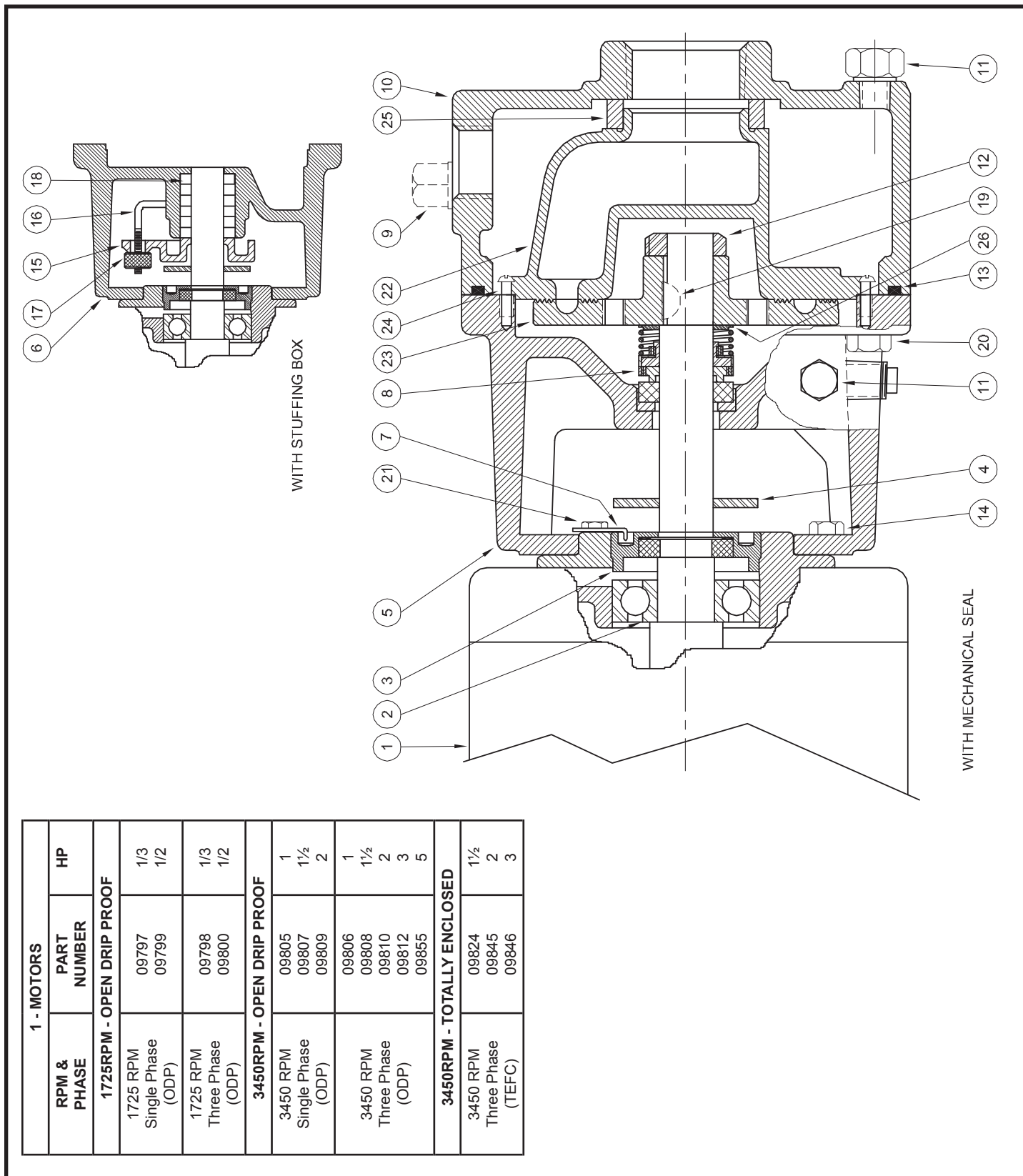

| 1 - MOTORS | | | HP |
|-----------------------------------|---|--|------------------------|
| RPM & PHASE | PART NUMBER | | |
| 1725RPM - OPEN DRIP PROOF | | | |
| 1725 RPM Single Phase (ODP) | 09797 09799 | | 1/3 1/2 |
| 1725 RPM Three Phase (ODP) | 09798 09800 | | 1/3 1/2 |
| 3450RPM - OPEN DRIP PROOF | | | |
| 3450 RPM Single Phase (ODP) | 09805 09807 09809 | | 1 1½ 2 |
| 3450 RPM Three Phase (ODP) | 09806 09808 09810 09812 09855 | | 1 1½ 2 3 5 |
| 3450RPM - TOTALLY ENCLOSED | | | |
| 3450 RPM Three Phase (TEFC) | 09824 09845 09846 | | 1½ 2 3 |

