

Close Coupled End Suction



1. RADIAL SPLIT CASING DESIGN

Casing is close grain iron of 30,000 p.s.i. minimum tensile strength. Back pull-out design eliminates the need to disturb piping should the pump ever require service - the casing stays in the line. Centerline discharge. Stud mounted casing assures positive alignment and allows rotation of discharge to eight different positions. Openings are provided for test gauges, for venting and for draining the pump.

2. ENCLOSED BRONZE IMPELLER

Enclosed bronze impeller is of latest hydraulic design for maximum efficiency. It is balanced for vibration free operation. Precision fit to shaft and double-locked with key and cap screw.

3. REPLACEABLE CASING WEAR RING

Prevents wear on casing and is easy to replace.

4. MECHANICAL SHAFT SEAL

Mechanical Shaft Seal is self-adjusting for temperatures up to 225°F (107°C) and pressures to 150 psi (1034kpa). Has ceramic seat and carbon seal faces for long trouble-free service. Special seals are available for higher temperatures and fluids other than water. Tapped opening is provided in the seal chamber for flushing seal faces.

MAXIMUM OPERATING CONDITIONS

Maximum Pumping Temperature*	225°F (107°C)
Maximum inlet Pressure	100 PSI (690kpa)
Maximum Case Working Pressure	200 PSI (1379kpa)

* FOR STANDARD BUNA-N SEAL

MATERIALS OF CONSTRUCTION

Part	Bronze Fitted	All Bronze	All Iron
Adapter	Cast Iron	Bronze	Cast Iron
Casing	Cast Iron	Bronze	Cast Iron
Casing Wear Ring	Bronze	Bronze	Steel
Shaft	Steel	Steel	Steel
Shaft Sleeve	Bronze	Bronze	#316 Stainless
Impeller	Bronze	Bronze	Cast Iron
Shaft Seal	Carbon-Ceramic SS - Buna-N	Carbon-Ceramic SS - Buna-N	Carbon-Ceramic SS - Buna-N

5. BRONZE SHAFT SLEEVE

Gasketed and keyed hook-type sleeve protects shaft wear and corrosion in seal area.

6. MOTORS

The standard Type JM motors supplied with these pumps offer the advantages of quiet operation, controlled shaft deflection for longer mechanical seal life and bearings sized to provide good service life. All motors are **supplied by** manufacturers providing field service facilities.

7. INTERCHANGEABILITY

The complete liquid end of any size pump is interchangeable between motors on close-coupled pumps and the BURKS power frames of comparable size providing inventory flexibility, plus an option for handling emergency service.

8. FACTORY TESTED

After careful assembly and inspection, EVERY pump is factory tested and will meet Hydraulic Institute standards.

FOR TEMPERATURES TO 500°F (260°C).

All models, with the exception of the G7-2-1/2 and all G9 series pumps are available in a Jacketed Seal Cavity design for pumping hot oil, hot water and heat transfer fluids in common use in high temperature heating or cooling applications. This feature greatly extends seal life in high temperature applications. To order, add suffix "MJ" to pump catalog number for temperatures below 400°F (204°C) and add suffix "MJK" to pump catalog number for temperatures over 400°F (204°C). Example: G6-1-1/2MJ. See Section on High Temperature Pumps for more information.

SUCTION & DISCHARGE SIZES

* SERIES	SUCTION (in)	DISCHARGE (in)
G6-1-1/2	2	1-1/2
G-2 & 2F	2-1/2	2
G6-2-1/2 & 2-1/2F	3	2-1/2
G7-2 & 2F	2-1/2	2
G7A-2 & 2F	2-1/2	2
G7-2-1/2 & 2-1/2F	3	2-1/2
G9-1-1/2	2	1-1/2
G9-2 & 2F	2-1/2	2
G9-2-1/2 & 2-1/2F	3	2-1/2
G9-3F & G9A-3F	4	3
G9-4F	5	4

*F Suffix Denotes ANSI 125# Flat Face Flanges



WARNING:

CANCER AND REPRODUCTIVE HARM -
WWW.P65WARNINGS.CA.GOV

Close Coupled End Suction

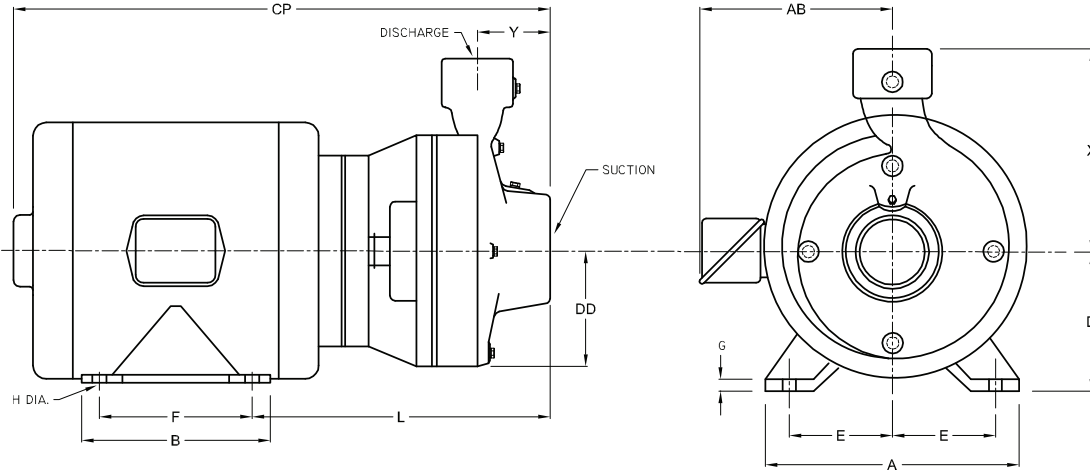

DIMENSIONS IN INCHES																		
MODEL		HP	MOTOR FRAME SIZE	DISC NPT (in)	SUCTION NPT (in)	A	AB	B	CP	D	DD	E	F	G	H	L	X	Y
1 Phase	3 Phase																	
1750 & 1450 RPM																		
104G7-2	3104G7-2	1	143JM	2	2½	7	8 ¹⁵ / ₁₆	5	16 ⁷ / ₈	3½	5	2¾	4	¾	1 ¹ / ₃₂	10 ⁷ / ₁₆	8¼	3¾
154G7-2	3154G7-2	1½	145JM			7	8 ¹⁵ / ₁₆	6	17 ⁷ / ₈	3½	5	2¾	5	¾	1 ¹ / ₃₂	10 ⁷ / ₁₆	8¼	3¾
204G7-2	----	2	182JM			8¾	9 ⁷ / ₈	5¾	18 ¹¹ / ₁₆	4½	5	3¾	4½	½	1 ³ / ₃₂	11 ³ / ₁₆	8¼	3¾
----	3204G7-2	2	145JM			7	8 ¹⁵ / ₁₆	6	17 ⁷ / ₈	3½	5	2¾	5	¾	1 ¹ / ₃₂	10 ⁷ / ₁₆	8¼	3¾
104G7A-2	310G7A-2	1	143JM	2	2½	7	8 ¹⁵ / ₁₆	5	16 ⁷ / ₈	3½	5	2¾	4	¾	1 ¹ / ₃₂	10 ⁷ / ₁₆	8¼	3¾
154G7A-2	3154G7A-2	1½	145JM			7	8 ¹⁵ / ₁₆	6	17 ⁷ / ₈	3½	5	2¾	5	¾	1 ¹ / ₃₂	10 ⁷ / ₁₆	8¼	3¾
204G7A-2	----	2	182JM			8¾	9 ⁷ / ₈	5¾	18 ¹¹ / ₁₆	4½	5	3¾	4½	½	1 ³ / ₃₂	11 ³ / ₁₆	8¼	3¾
----	3204G7A-2	2	145JM			7	8 ¹⁵ / ₁₆	6	17 ⁷ / ₈	3½	5	2¾	5	¾	1 ¹ / ₃₂	10 ⁷ / ₁₆	8¼	3¾
154G7-2½	3154G7-2½	1½	145JM	2½	3	7	8 ¹⁵ / ₁₆	6	17 ⁷ / ₈	3½	5½	2¾	5	¾	1 ¹ / ₃₂	10 ⁷ / ₁₆	9¼	3½
204G7-2½	----	2	182JM			8¾	9 ⁷ / ₈	5¾	18 ¹¹ / ₁₆	4½	5½	3¾	4½	½	1 ³ / ₃₂	11 ³ / ₁₆	9¼	3½
----	3204G7-2½	2	145JM			7	8 ¹⁵ / ₁₆	6	17 ⁷ / ₈	3½	5½	2¾	5	¾	1 ¹ / ₃₂	10 ⁷ / ₁₆	9¼	3½
304G7-2½	----	3	184JM			8¾	9 ⁷ / ₈	6¾	19 ¹¹ / ₁₆	4½	5½	3¾	5½	½	1 ³ / ₃₂	11 ³ / ₁₆	9¼	3½
----	3304G7-2½	3	182JM	8¾	9 ⁷ / ₈	5¾	18 ¹¹ / ₁₆	4½	5½	3¾	4½	½	1 ³ / ₃₂	11 ³ / ₁₆	9¼	3½		
3500 & 2900 RPM																		
50G7-2	----	5	184JM	2	2½	8¾	9 ⁷ / ₈	6¾	19 ¹¹ / ₁₆	4½	5	3¾	5½	½	1 ³ / ₃₂	11 ³ / ₁₆	8¼	3¾
----	350G7-2	5	182JM			8¾	9 ⁷ / ₈	5¾	18 ¹¹ / ₁₆	4½	5	3¾	4½	½	1 ³ / ₃₂	11 ³ / ₁₆	8¼	3¾
----	375G7-2	7½	184JM			8¾	9 ⁷ / ₈	6¾	19 ¹¹ / ₁₆	4½	5	3¾	5½	½	1 ³ / ₃₂	11 ³ / ₁₆	8¼	3¾
----	3100G7-2	10	213JM			10 ³ / ₈	11 ¹ / ₁₆	7¼	21¼	5¼	5	4¼	5½	5 ⁵ / ₈	1 ³ / ₃₂	12 ⁵ / ₁₆	8¼	3¾
50G7A-2	----	5	184JM	2	2½	8¾	9 ⁷ / ₈	6¾	19 ¹¹ / ₁₆	4½	5	3¾	5½	½	1 ³ / ₃₂	11 ³ / ₁₆	8¼	3¾
----	350G7A-2	5	182JM			8¾	9 ⁷ / ₈	5¾	18 ¹¹ / ₁₆	4½	5	3¾	4½	½	1 ³ / ₃₂	11 ³ / ₁₆	8¼	3¾
----	375G7A-2	7½	184JM			8¾	9 ⁷ / ₈	6¾	19 ¹¹ / ₁₆	4½	5	3¾	5½	½	1 ³ / ₃₂	11 ³ / ₁₆	8¼	3¾
----	3100G7A-2	10	213JM			10 ³ / ₈	11 ¹ / ₁₆	7¼	21¼	5¼	5	4¼	5½	5 ⁵ / ₈	1 ³ / ₃₂	12 ⁵ / ₁₆	8¼	3¾
----	3150G7A-2	15	215JM	10 ³ / ₈	11 ¹ / ₁₆	8¾	22 ⁵ / ₈	5¼	5	4¼	7	5 ⁵ / ₈	1 ³ / ₃₂	12 ⁵ / ₁₆	8¼	3¾		
----	3150G7-2½	15	215JM	2½	3	10 ³ / ₈	11 ¹ / ₁₆	8¾	22 ⁵ / ₈	5¼	5½	4¼	7	5 ⁵ / ₈	1 ³ / ₃₂	12 ⁵ / ₁₆	9¼	3½
----	3200G7-2½	20	254JM			12	11 ¹ / ₁₆	10¼	26 ³ / ₁₆	6¼	5½	5	8¼	7 ⁵ / ₈	1 ⁷ / ₃₂	13 ⁷ / ₈	9¼	3½
----	3250G7-2½	25	256JM			12	11 ¹ / ₁₆	12	27 ¹⁵ / ₁₆	6¼	5½	5	10	7 ⁵ / ₈	1 ⁷ / ₃₂	13 ⁷ / ₈	9¼	3½
----	3300G7-2½	30	284JM			13¾	13	11½	27 ¹⁵ / ₁₆	7	5½	5½	9½	7 ⁵ / ₈	1 ⁷ / ₃₂	13 ⁷ / ₈	9¼	3½

DIMENSIONS SHOWN ABOVE ARE APPROXIMATE MAXIMUM DIMENSIONS FOR STANDARD PUMPS EQUIPPED WITH ODP MOTORS.

Close Coupled End Suction



Close Coupled End Suction



Centrifugals - Close Coupled



1 - MOTORS		HP	FRAME SIZE
OPEN DRIP PROOF			
1750 RPM Single Phase (ODP)	21393	1	143JM
	21394	1½	145JM
	21395	2	182JM
1750 RPM Three Phase (ODP)	21396	3	184JM
	21419	1	143JM
	21420	1½	145JM
3500 RPM Single Phase (ODP)	21421	2	145JM
	21422	3	182JM
	09902	5	184JM
	21850	7½	213JM
3500 RPM Three Phase (ODP)	09906	5	182JM
	09907	7½	184JM
	09999	10	213JM
	20002	15	215JM
	21169	20	254JM
	21170	25	256JM
	21207	30	284JM
TOTALLY ENCLOSED			
1750 RPM Single Phase (TEFC)	21399	1	143JM
	21400	1½	145JM
	21401	2	182JM
	21402	3	184JM
1750 RPM Three Phase (TEFC)	21403	5	213JM
	21426	1	143JM
	21427	1½	145JM
	21428	2	145JM
	21429	3	182JM
3500 RPM Three Phase (TEFC)	21430	5	184JM
	09950	5	184JM
	09951	7½	213JM
	20000	10	215JM
	20003	15	254JM
	21195	20	256JM
	21457	25	284JM
	21215	30	286JM
EXPLOSION PROOF			
1750 RPM Three Phase (XP)	21433	1	143JM
	21434	1½	145JM
	21435	2	145JM
	21436	3	182JM
3500 RPM Three Phase (XP)	21437	5	184JM
	09954	5	184JM
	09955	7½	213JM
	20001	10	215JM
	20004	15	254JM
	21196	20	256JM
	21458	25	284JM
	21218	30	286JM

Centrifugals - Close Coupled

SYMBOL NUMBER	PART NUMBER	QTY	DESCRIPTION
+15	PUMPS with 143-215JM Motors		
	09933	1	Flat Gasket +
	22083	1	O-Ring Gasket - Buna N (Std)
	22084	1	O-Ring Gasket - Viton
	22094	1	O-Ring Gasket - EPT**
	22085	1	O-Ring Gasket - Teflon
	PUMPS with 254-286JM Motors		
	21090	1	Flat Gasket +
	22140	1	O-Ring Gasket - Buna N (Std)
	22141	1	O-Ring Gasket - Viton
22143	1	O-Ring Gasket - EPT**	
22142	1	O-Ring Gasket - Teflon	
+16	PUMPS with 143-215JM Motors		
	09911	1	Flat Gasket +
	22083	1	O-Ring Gasket - Buna N (Std)
	22084	1	O-Ring Gasket - Viton
	22094	1	O-Ring Gasket - EPT**
	22085	1	O-Ring Gasket - Teflon
	PUMPS with 254-286JM Motors		
	21092	1	Flat Gasket +
	22089	1	O-Ring Gasket - Buna N (Std)
	22090	1	O-Ring Gasket - Viton
22096	1	O-Ring Gasket - EPT**	
22091	1	O-Ring Gasket - Teflon	
+17	20418	1	Flat Gasket +
	125857-200	1	O-Ring Gasket - Buna N (Std)
	23004	1	O-Ring Gasket - Viton
	23005	1	O-Ring Gasket - EPT**
	23006	1	O-Ring Gasket - Teflon
18	PUMPS with 143-215JM Motors		
	09917		Mechanical Seal - Buna-N (Std)
	09926		Mechanical Seal - Viton
	21271		Mechanical Seal - EPT**
	PUMPS with 254-286JM Motors		
	21136		Mechanical Seal - Buna-N (Std)
21189		Mechanical Seal - Viton	
21721		Mechanical Seal - EPT**	

"CONTINUED ON NEXT PAGE"

- (*) Casing Assy. Includes Symbols 4, 9 & 14.
- (**) For hot water and Caustic service.
- (+) Series G7-2, G7A-2 & G7-2-1/2 pumps have been manufactured with either a flat or O-ring type gasket. Determine which type is required before ordering. When in doubt, order flat gasket.
- (*) Adapter Assy. includes symbol 5.

SYMBOL NUMBER	PART NUMBER	QTY	DESCRIPTION
2	20650	1	Adapter - 143-184JM Motors
	20419	1	Adapter - 213-215JM Motors
	21086	1	Adapter Assy ♦ - 254-256 JM Motors
	21310	1	Adapter Assy ♦ - 284-286 JM Motors
3	1750 RPM		
	20420-7.00	1	Impeller - 104G7-2 & 3104G7-2
	20420-7.56	1	Impeller - 154G7-2 & 3154G7-2
	20421-6.56	1	Impeller - 104G7A-2 & 3104G7A-2
	20421-7.06	1	Impeller - 154G7A-2 & 3154G7A-2
	20421-7.63	1	Impeller - 204G7A-2 & 3204G7A-2
	21087-1-6.13	1	Impeller - 154G7-2-1/2 & 3154G7-2-1/2
	21087-1-6.50	1	Impeller - 204G7-2-1/2 & 3204G7-2-1/2
	21087-1-7.25	1	Impeller - 304G7-2-1/2 & 3304G7-2-1/2
	3450 RPM		
	20420-6.25	1	Impeller - 50G7-2 & 350G7-2
	20420-6.88	1	Impeller - 375G7-2
20420-7.38	1	Impeller - 3100G7-2	
20420-7.56	1	Impeller - 3150G7-2	
20420-1	1	Impeller - 254JM Motor	
20421-5.81	1	Impeller - 50G7A-2 & 350G7A-2	
20421-6.31	1	Impeller - 375G7A-2	
20421-6.75	1	Impeller - 3100G7A-2	
20421-7.56	1	Impeller - 3150G7A-2	
20421-1-7.63	1	Impeller - 3200G7A-2	
21087-6.75	1	Impeller - 3200G7-2-1/2	
21087-7.38	1	Impeller - 3250G7-2-1/2	
21087-7.56	1	Impeller - 3300G7-2-1/2	
*4	22153	1	Casing Assy - G7-2 & G7A-2
	22271	1	Casing Assy - G7-2F & G7A-2F (Flanged)
	22154	1	Casing Assy - G7-2-1/2
	22272	1	Casing Assy - G7-2-1/2F (Flanged)
5	09915	1	Wear Ring - G7-2 & G7A-2
	20680	2	Wear Ring - G7-2-1/2
6	04235	4	Cap Screw - Use with 20650 Adapter
	1-68-6	4	Cap Screw - Use with 20419 & 21086 Adapter
	21289	4	Cap Screw - Use with 21310 Adapter
7	20424	8	Stud
	15-6-6	8	Nut
	20059	8	Washer
	23014	1	Key - 143-215JM Motors
8	23017	1	Key - 254-286JM Motors
	01691-A	6	Pipe Plug 1/8" - Bronze
	04236	1	Pipe Plug 1/4" - Bronze
	1-529-1	1	Cap Screw SS - 143-215JM Motors
14	1-68-1	1	Cap Screw SS - 254-286JM Motors
	22105-C	1	Washer - Bronze - 143-215JM Motors
22106	1	Washer - Bronze - 254-286JM Motors	

WARNING:

CANCER AND REPRODUCTIVE HARM -
WWW.P65WARNINGS.CA.GOV



Centrifugals - Close Coupled

SYMBOL NUMBER	PART NUMBER	QTY	DESCRIPTION
DIFFERING PARTS FOR ALL IRON CONSTRUCTION			
2	21086-B	1	Adapter Assy - 254-256 JM Motors
	21310-B	1	Adapter Assy - 284-286 JM Motors
3	20420-A	1	Impeller - Iron
	20421-A	1	Impeller - Iron
	20421-A-1	1	Impeller - Iron
	21087-A	1	Impeller - Iron
Size suffixes same as standard bronze impellers			
6	03288	4	Cap Screw - for 20650-A Adapter
	01638-B	4	Cap Screw - for 20419-B & 21086-A Adapter
	03160-A	8	Nut
*4	22153-B	1	Casing Assy - G7-2 & G7A-2
	22271-B	1	Casing Assy - G7-2F & G7A-2F (Flanged)
	22154-B	1	Casing Assy - G7-2-1/2
	22272-B	1	Casing Assy - G7-2-1/2F (Flanged)
5	09915-A	1	Wear Ring - G7-2 & G7A-2
	20680-A	2	Wear Ring - G7-2-1/2
11	00158	6	Pipe Plug 1/8" - Steel
	04236-A	1	Pipe Plug 1/4" - SS
14	22105-A	1	Washer - Steel - 143-215JM Motors
	22106-A	1	Washer - Steel - 254-286JM Motors
20	22063-A	1	Shaft Sleeve - Bronze - 143-215JM Motors
	22066-A	1	Shaft Sleeve - Bronze - 254-286JM Motors

(*) Casing Assy. Includes Symbols 4, 9 & 14.
 (**) For hot water or Caustic service.
 (+) Series G7-2, G7A-2 & G7-2-1/2 pumps have been manufactured with either a flat or O-ring type gasket. Determine which type is required before ordering. When in doubt, order flat gasket.
 (♦) Adapter Assy. includes symbol 5.

SYMBOL NUMBER	PART NUMBER	QTY	DESCRIPTION
PUMPS with 143-215JM Motors			
19	22080	1	O-Ring Gasket - Buna N (Std)
	2-31005-012	1	O-Ring Gasket - Viton
	22093	1	O-Ring Gasket - EPT**
	22082	1	O-Ring Gasket - Teflon
PUMPS with 254-286JM Motors			
20	22086	1	O-Ring Gasket - Buna N (Std)
	22087	1	O-Ring Gasket - Viton
	22095	1	O-Ring Gasket - EPT**
	22088	1	O-Ring Gasket - Teflon
	22063-C	1	Shaft Sleeve - Bronze - 143-215JM Motors
	22066	1	Shaft Sleeve - Bronze - 254-286JM Motors
21	09918	1	Slinger Washer - 143-215JM Motors
	21093	1	Slinger Washer - 254-286JM Motors
DIFFERING PARTS FOR ALL BRONZE CONSTRUCTION			
2	20650-A	1	Adapter - 143-184JM Motors
	20419-B	1	Adapter - 213-215JM Motors
	21086-A	1	Adapter Assy - 254-256JM Motors
	21310-A	1	Adapter Assy - 284-286JM Motors
*4	22153-A	1	Casing Assy - G7-2 & G7A-2
	22271-A	1	Casing Assy - G7-2F & G7A-2F (Flanged)
	22154-A	1	Casing Assy - G7-2-1/2
	22272-A	1	Casing Assy - G7-2-1/2F (Flanged)
13	03289	1	Cap Screw, Bronze - 143-215JM Motors
	01638-B	1	Cap Screw, Bronze - 254-286JM Motors

WARNING:
 CANCER AND REPRODUCTIVE HARM -
 WWW.P65WARNINGS.CA.GOV

