

Close Coupled End Suction

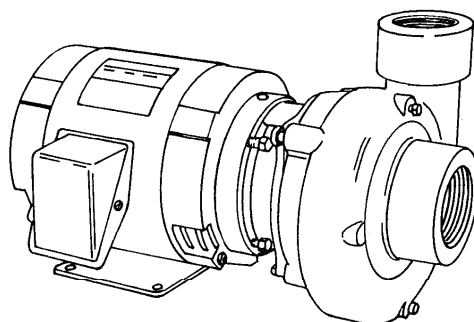

1750 RPM - 60Hz.
CAPACITIES TO 320 GPM (20.2 LPS)
HEADS TO 39 FEET (12 M)

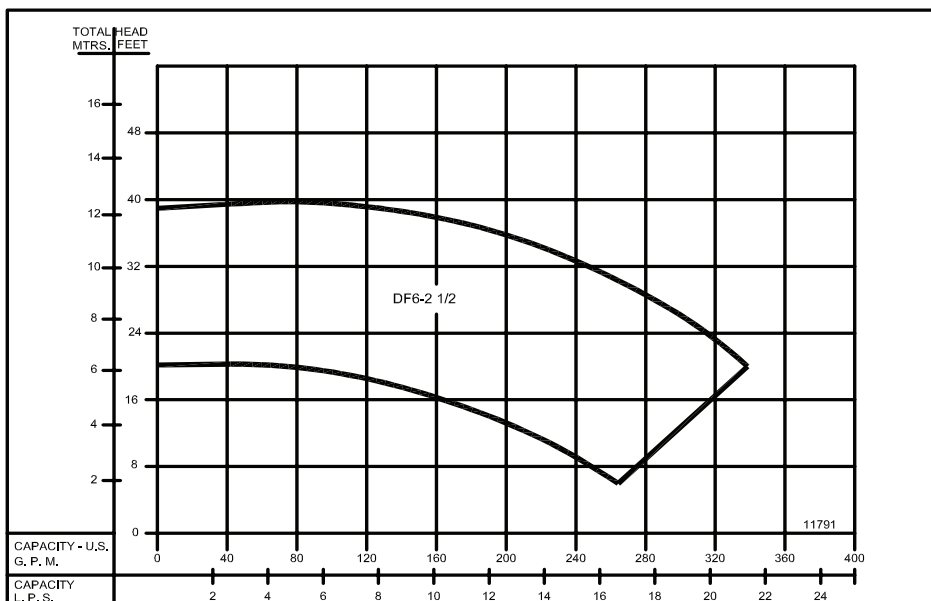

1450 RPM - 50Hz.
CAPACITIES TO 280 GPM (17.7 LPS)
HEADS TO 27 FEET (8.3 M)



Individual performance curves should be checked for final selection.

Close Coupled End Suction

FOUR POSITION CASING

Discharge can be located in any of four positions. Back pull-out design eliminates the need to disturb piping should the pump ever require service - the casing stays in the line.

ENCLOSED IMPELLER

Of the latest hydraulic design for maximum efficiency, impeller is balanced for vibration-free operation. It is precision fit to shaft with key drive and cap screw lock.

MECHANICAL SHAFT SEAL

Standard self-adjusting shaft seal for temperatures to 225°F (107°C) and pressures to 150 psi (1034kpa). Ceramic seat and carbon seal face for long trouble-free service. Special seals are available for higher temperatures and fluids other than water.

SHAFT SLEEVE

Gasketed and keyed hook-type sleeve protects shaft from wear and corrosion in seal area.

FACTORY TESTED

After careful assembly and inspection, EVERY pump is factory tested and will meet Hydraulic Institute standards.

MOTORS

JM Type motors have NEMA standard mounting flange, extended steel shaft and dual bearings. These motors offer the advantages of quiet operation, controlled shaft deflection for longer seal life, and bearings sized to provide good service life. All motors are supplied by manufacturers with national field service facilities.

MOTOR INFORMATION

60 Hz - 1750 RPM - ODP

50 Hz - 1450 RPM - ODP

Single Phase: 115/230 V

Three Phase: 208-230/460 V

Voltages may differ from some suppliers. Consult factory.

OVERLOAD PROTECTION

All single phase ODP and Totally Enclosed motors have built-in overload protection. All three phase motors and all explosion proof motors must be installed with a magnetic starter which provides full 3-leg protection. Failure to use correct starter and overloads will void motor warranty.

MATERIALS OF CONSTRUCTION

PART	ALL IRON	BRONZE FITTED	ALL BRONZE
Adapter	Cast Iron	Cast Iron	Bronze
Casing	Cast Iron	Cast Iron	Bronze
Impeller	Cast Iron	Bronze	Bronze
Shaft	Steel	Steel	Steel
Shaft Sleeve	#316 Stainless	Bronze	Bronze
Shaft Seal	Carbon-Ceramic SS - Buna-N	Carbon-Ceramic SS - Buna-N	Carbon-Ceramic SS - Buna-N

MAXIMUM OPERATING CONDITIONS

TEMPERATURE (For Standard Buna-N Seal)	225°F (107°C)
INLET PRESSURE	100 PSI (433 kpa)
CASING WORKING PRESSURE	200 PSI (1379 kpa)



WARNING:

CANCER AND REPRODUCTIVE HARM -
WWW.P65WARNINGS.CA.GOV

Close Coupled End Suction

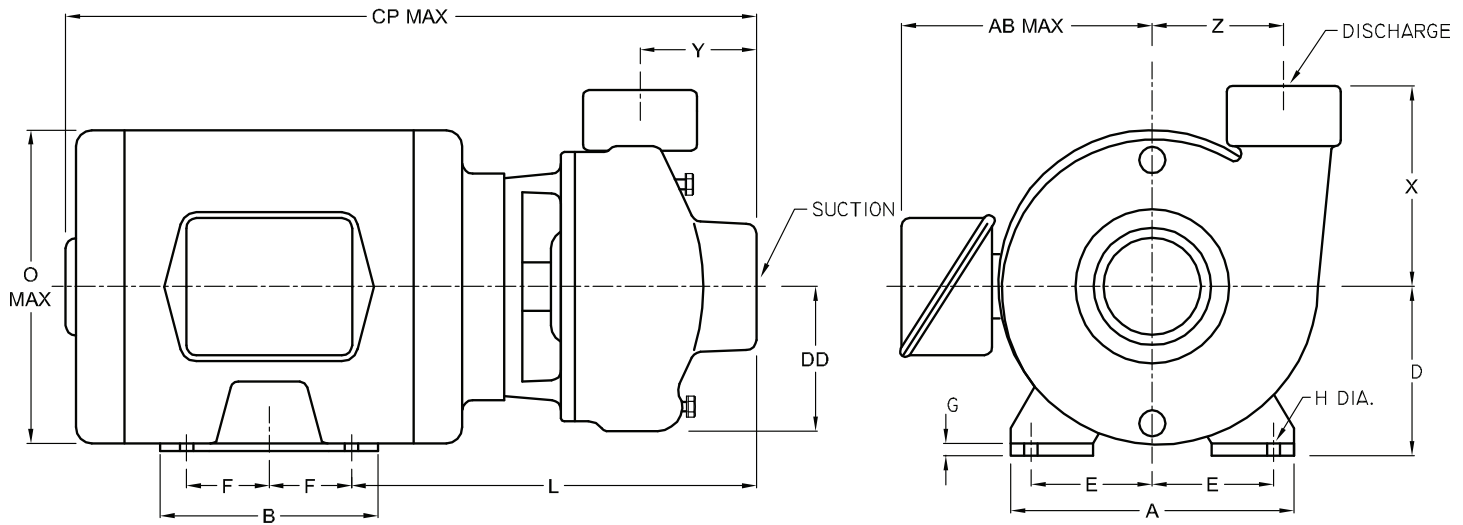

DIMENSIONS IN INCHES (mm)																			
MODEL	HP	MOTOR FRAME SIZE	DISC NPT (in)	SUCT. NPT (in)	A	AB	B	CP	D	DD	E	F	G	H	L	O	X	Y	Z
DF6-2 1/2	1	143JM	2 1/2	3	7 (178)	6 3/16 (157)	6 1/2 (165)	17 15/16 (456)	3 1/2 (89)	5 3/16 (132)	2 3/4 (70)	2 (51)	1/8 (3)	1 1/32 (8.7)	10 15/16 (278)	7 7/8 (187)	6 1/16 (154)	3 7/16 (87)	4 5/16 (110)
	1 1/2	145JM	2 1/2	3	7 (178)	6 3/16 (157)	6 1/2 (165)	18 7/16 (468)	3 1/2 (89)	5 3/16 (132)	2 3/4 (70)	2 1/2 (64)	1/8 (3)	1 1/32 (8.7)	10 15/16 (278)	7 7/8 (187)	6 1/16 (154)	3 7/16 (87)	4 5/16 (110)
	2	182JM	2 1/2	3	8 3/4 (222)	8 9/16 (217)	5 3/4 (146)	20 3/8 (518)	4 1/2 (114)	5 3/16 (132)	3 3/4 (95)	2 1/4 (57)	3/16 (4.7)	1 3/32 (10.3)	11 11/16 (297)	9 11/16 (246)	6 1/16 (154)	3 7/16 (87)	4 5/16 (110)
	3	184JM	2 1/2	3	8 3/4 (222)	8 9/16 (217)	6 3/4 (171)	21 7/8 (556)	4 1/2 (114)	5 3/16 (132)	3 3/4 (95)	2 3/4 (70)	3/16 (4.7)	1 3/32 (10.3)	11 11/16 (297)	9 11/16 (246)	6 1/16 (154)	3 7/16 (87)	4 5/16 (110)

DIMENSIONS SHOWN ABOVE ARE APPROXIMATE MAXIMUM DIMENSIONS FOR STANDARD PUMPS EQUIPPED WITH ODP MOTORS.

Close Coupled End Suction

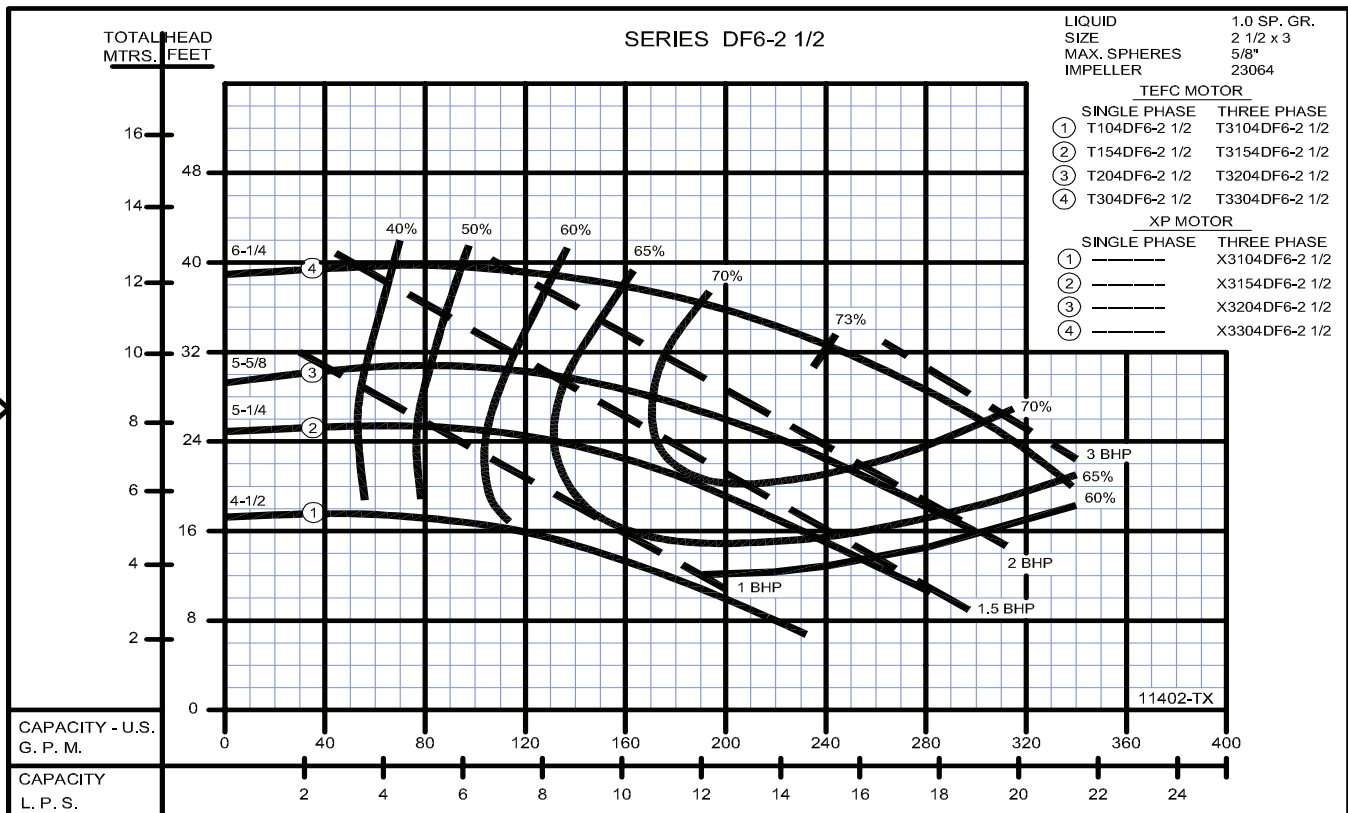

Centrifugals - Close Coupled



1 - MOTORS		HP	FRAME SIZE
RPM & PHASE	PART NUMBER		
OPEN DRIP PROOF			
1750 RPM Single Phase (ODP)	21393	1	143JM
	21394	1½	145JM
	21395	2	182JM
	21396	3	184JM
1750 RPM Three Phase (ODP)	21419	1	143JM
	21420	1½	145JM
	21421	2	182JM
	21422	3	184JM
TOTALLY ENCLOSED			
1750 RPM Single Phase (TEFC)	21399	1	143JM
	21400	1½	145JM
	21401	2	182JM
	21402	3	184JM
1750 RPM Three Phase (TEFC)	21426	1	143JM
	21427	1½	145JM
	21428	2	145JM
	21429	3	182JM
EXPLOSION PROOF			
1750 RPM Three Phase (XP)	21433	1	143JM
	21434	1½	145JM
	21435	2	145JM
	21436	3	182JM



www.cranepumps.com

Centrifugals - Close Coupled

SYMBOL NUMBER	PART NUMBER	QTY	DESCRIPTION
DIFFERING PARTS FOR BRONZE FITTED			
7	03289	1	Cap Screw
9	22105-C	1	Washer - Alum. Bronze
11	23064-A	1	Impeller
16	22063-C	1	Shaft Sleeve
DIFFERING PARTS FOR ALL BRONZE			
2	22002-A	1	Adapter
4	01691-A	3	Plug
6	23909-A	1	Casing
7	03289	1	Cap Screw
9	22105-C	1	Washer, Alum. Bronze
11	23064-A	1	Impeller
16	22063-C	1	Shaft Sleeve

(**) For hot water or Caustic service.

SYMBOL NUMBER	PART NUMBER	QTY	DESCRIPTION
2	22002	1	Adapter
3	09918	1	Slinger Washer
4	23014	1	Key
5	00158	3	Pipe Plug - 1/8"
6	23909	1	Casing
7	1-529-1	1	Cap Screw - SS
8	22080	1	O-Ring Gasket - Buna-N (Std)
	2-31005-012	1	O-Ring Gasket - Viton
	22093	1	O-Ring Gasket - EPDM**
9	22105-A	1	Washer - Steel
10	22083	2	O-Ring Gasket - Buna-N (Std)
	22084	2	O-Ring Gasket - Viton
	22094	2	O-Ring Gasket - EPT**
11	23064-4.88	1	Impeller - 104DF6-2-1/2AI & 3104DF6-2-1/2AI
	23064-5.44	1	Impeller - 154DF6-2-1/2AI & 3154DF6-2-1/2AI
	23064-5.81	1	Impeller - 204DF6-2-1/2AI & 3204DF6-2-1/2AI
	23064-6.25	1	Impeller - 304DF6-2-1/2AI & 3304DF6-2-1/2AI
12	2-31003-166	1	O-Ring Gasket - Buna-N (Std)
	2-31005-166	1	O-Ring Gasket - Viton
	22098	1	O-Ring Gasket - EPT**
13	23905	4	Stud
	23906	4	Hex Nut
14	21236	4	Cap Screw
15	09917	1	Mechanical Seal - Buna-N (Std)
	09926	1	Mechanical Seal - Viton
	21271	1	Mechanical Seal - EPT**
16	22063-A	1	Shaft Sleeve - SS

WARNING:
 CANCER AND REPRODUCTIVE HARM -
 WWW.P65WARNINGS.CA.GOV



PUMPS & SYSTEMS

SECTION	CCCCP
PAGE	39
DATE	11/18