

**Series: GA6-1 1/2, GA6-2,
GA7-1 1/4, GA7-1 1/2**

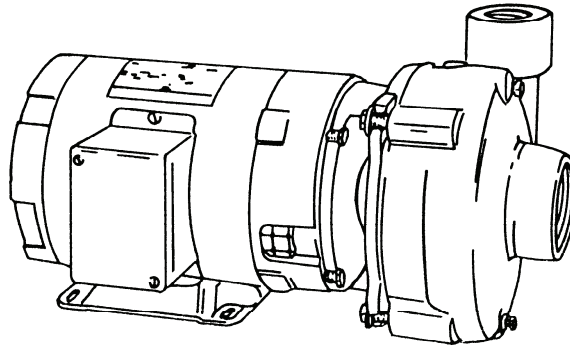

Close Coupled End Suction



3500 RPM - 60Hz.
CAPACITIES TO 300 GPM (19 LPS)
HEADS TO 230 FEET (70 M)

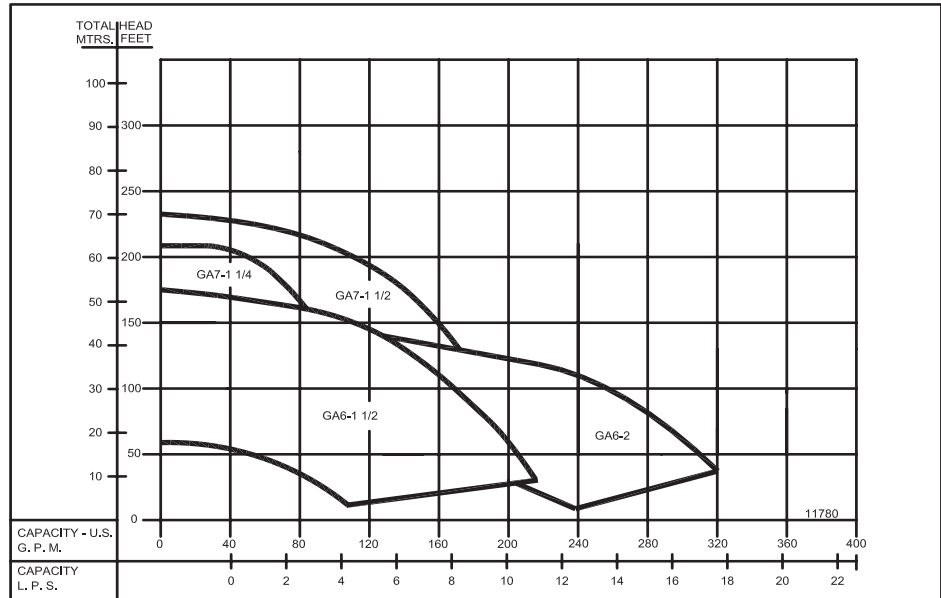

2900 RPM - 50Hz.
CAPACITIES TO 280 GPM (18 LPS)
HEADS TO 152 FEET (46.3 M)

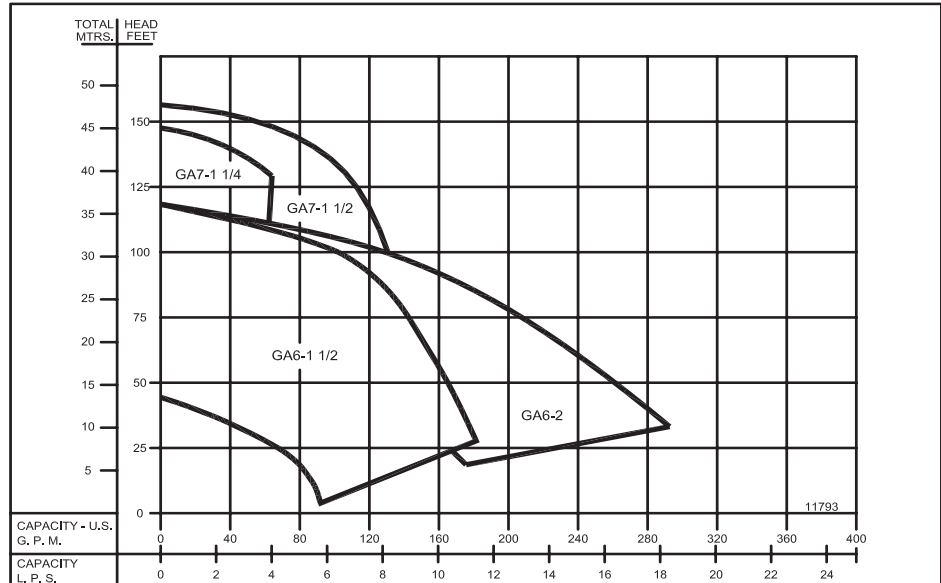

Individual performance curve should be checked for final selection.

Close Coupled End Suction

FOUR POSITION CASING

Discharge can be located in any of four positions. Casing is close grain iron of 30,000 psi minimum tensile strength. Back pull-out design eliminates the need to disturb piping should the pump ever require service - the casing stays in the line.

ENCLOSED BRONZE IMPELLER

Of the latest hydraulic design for maximum efficiency, impeller is balanced for vibration-free operation. It is precision fit to shaft with key drive and cap screw lock.

MECHANICAL SHAFT SEAL

Standard self-adjusting shaft seal for temperatures to 225°F (107°C) and pressures to 150 psi (1034kpa). Ceramic seat and carbon seal face for long trouble-free service. Special seals are available for higher temperatures and fluids other than water.

BRONZE SHAFT SLEEVE

Gasketed and keyed hook-type sleeve protects shaft from wear and corrosion in seal area.

MOTORS

JM Type motors have NEMA standard mounting flange, extended steel shaft and dual bearings. These motors offer the advantages of quiet operation, controlled shaft deflection for longer seal life, and bearings sized to provide good service life. All motors are supplied by manufacturers with national field service facilities.

FACTORY TESTED

After careful assembly and inspection, EVERY pump is factory tested and will meet Hydraulic Institute standards.

MAXIMUM OPERATING CONDITIONS

TEMPERATURE (For Standard Buna-N Seal)	225°F (107°C)
INLET PRESSURE	100 PSI (690kPa)
CASING WORKING PRESSURE	200 PSI (1379kPa)

MOTOR INFORMATION

60 Hz - 1750 RPM - ODP

60 Hz - 3500 RPM - ODP

Single Phase: 1 thru 2 Hp. - 115/230 V

3 & 7 1/2 Hp. - 230 V.

Three Phase: 1 thru 10 Hp. - 230/460 V

50 Hz - 2900 RPM - ODP

50 Hz - 1450 RPM - ODP

Single Phase: 110/220 Volt

Three Phase: 380 Volt

Voltages may differ from some suppliers. Consult factory.

Overload Protection: All motors must be installed with magnetic starter which provides full overload protection on all legs. Failure to use correct starter and overloads will void motor warranty.

GA6 Series pumps are not available with 7-1/2 HP Totally Enclosed or Explosion Proof motors.

MATERIALS OF CONSTRUCTION

PART	◆ ALL IRON	BRONZE FITTED	ALL BRONZE
Adapter	Cast Iron	Cast Iron	Bronze
Casing	Cast Iron	Cast Iron	Bronze
Impeller	Cast Iron	Bronze	Bronze
Shaft	Steel	Steel	Steel
Shaft Sleeve	#316 Stainless	Bronze	Bronze
Shaft Seal	Carbon-Ceramic SS - Buna-N	Carbon-Ceramic SS - Buna-N	Carbon-Ceramic SS - Buna-N

(◆) Does NOT include GA7-1½.



WARNING:

CANCER AND REPRODUCTIVE HARM -
WWW.P65WARNINGS.CA.GOV

Series: **GA6-1 1/2, GA6-2, GA7-1 1/4, GA7-1 1/2**

Dimensions



Close Coupled End Suction



MODEL		HP	MOTOR FRAME SIZE	DISC NPT (in)	SUCT NPT (in)	DIMENSIONS IN INCHES															
1 Phase	3 Phase					A	AB	B	CP	D	DD	E	F	G	H	L	X	Y	Z		
104GA6-1 1/2	3104GA6-1 1/2	1	143JM	1 1/2	2	7	8 15/16	5	15 13/16	4 5/16	3 1/2	2 3/4	2	3/8	1 1/32	9 5/8	4 3/4	2 9/16	3 13/16		
15GA6-1 1/2	315GA6-1 1/2	1 1/2	143JM			7	8 15/16	5	15 13/16	4 5/16	3 1/2	2 3/4	2	2	3/8	1 1/32	9 5/8	4 3/4	2 9/16	3 13/16	
20GA6-1 1/2	320GA6-1 1/2	2	145JM			7	8 15/16	6	16 13/16	4 5/16	3 1/2	2 3/4	2 1/2	3/8	1 1/32	9 5/8	4 3/4	2 9/16	3 13/16		
30GA6-1 1/2	330GA6-1 1/2	3	145JM			7	8 15/16	6	16 13/16	4 5/16	3 1/2	2 3/4	2 1/2	3/8	1 1/32	9 5/8	4 3/4	2 9/16	3 13/16		
50GA6-1 1/2	350GA6-1 1/2	5	182JM			8 3/4	9 7/8	5 3/4	17 9/16	4 5/16	4 1/2	3 3/4	2 1/4	1/2	1 3/32	10 3/8	4 3/4	2 9/16	3 13/16		
----	375GA6-1 1/2	7 1/2	184JM			8 3/4	9 7/8	6 3/4	18 9/16	4 5/16	4 1/2	3 3/4	2 3/4	1/2	1 3/32	10 3/8	4 3/4	2 9/16	3 13/16		
104GA6-2	3104GA6-2	1	143JM	2	2 1/2	7	8 15/16	5	16 1/16	4 5/8	3 1/2	2 3/4	2	3/8	1 1/32	9 7/8	5 7/16	2 3/4	4		
154GA6-2	3154GA6-2	1 1/2	145JM			7	8 15/16	6	17 1/16	4 5/8	3 1/2	2 3/4	2 1/2	3/8	1 1/32	9 7/8	5 7/16	2 3/4	4		
30GA6-2	330GA6-2	3	145JM			7	8 15/16	6	17 1/16	4 5/8	3 1/2	2 3/4	2 1/2	3/8	1 1/32	9 7/8	5 7/16	2 3/4	4		
50GA6-2	350GA6-2	5	182JM			8 3/4	9 7/8	5 3/4	17 13/16	4 5/8	4 1/2	3 3/4	2 1/4	1/2	1 3/32	10 3/8	5 7/16	2 3/4	4		
----	375GA6-2	7 1/2	184JM			8 3/4	9 7/8	6 3/4	18 13/16	4 5/8	4 1/2	3 3/4	2 3/4	1/2	1 3/32	10 3/8	5 7/16	2 3/4	4		
30GA7-1 1/4	330GA7-1 1/4	3	145JM			1 1/4	1 1/2	7	8 15/16	6	17 7/16	3 1/2	4 1/2	2 3/4	2 1/2	3/8	1 1/32	10 1/4	5 5/8	3 5/16	4 1/16
50GA7-1 1/4	350GA7-1 1/4	5	182JM	8 3/4	9 7/8			5 3/4	18 3/16	4 1/2	4 1/2	3 3/4	2 1/4	1/2	1 3/32	11	5 5/8	3 5/16	4 1/16		
----	375GA7-1 1/4	7 1/2	184JM	8 3/4	9 7/8			6 3/4	19 3/16	4 1/2	4 1/2	3 3/4	2 3/4	1/2	1 3/32	11	5 5/8	3 5/16	4 1/16		
104GA7-1 1/2	3104GA7-1 1/2	1	143JM	1 1/2	2			7	8 15/16	5	16 1/2	3 1/2	4 9/16	2 3/4	2	3/8	1 1/32	10 5/16	6	3 5/16	4 1/4
154GA7-1 1/2	3154GA7-1 1/2	1 1/2	145JM					7	8 15/16	6	17 1/2	3 1/2	4 9/16	2 3/4	2 1/2	3/8	1 1/32	10 5/16	6	3 5/16	4 1/4
50GA7-1 1/2	----	5	184JM					9	9 7/8	6 3/4	19 1/4	4 1/2	4 9/16	3 3/4	2 3/4	1/2	1 3/32	11 1/16	6	3 5/16	4 1/4
----	350GA7-1 1/2	5	182JM			9	9 7/8	5 3/4	18 1/4	4 1/2	4 9/16	3 3/4	2 1/4	1/2	1 3/32	11 1/16	6	3 5/16	4 1/4		
75GA7-1 1/2	----	7 1/2	213JM			10 1/2	11 1/16	7 1/4	20 3/4	5 1/4	4 9/16	4 1/4	2 3/4	5/8	1 3/32	11 15/16	6	3 5/16	4 1/4		
----	375GA7-1 1/2	7 1/2	184JM			9	9 7/8	6 3/4	19 1/4	4 1/2	4 9/16	3 3/4	2 3/4	1/2	1 3/32	11 1/16	6	3 5/16	4 1/4		
----	3100GA7-1 1/2	10	213JM	10 1/2	11 1/16	7 1/4	20 3/4	5 1/4	4 9/16	4 1/4	2 3/4	5/8	1 3/32	11 15/16	6	3 5/16	4 1/4				

DIMENSIONS SHOWN ABOVE ARE APPROXIMATE MAXIMUM DIMENSIONS FOR STANDARD PUMPS EQUIPPED WITH ODP MOTORS.

Close Coupled End Suction



DIMENSIONS IN MILLIMETERS																			
MODEL		HP	MOTOR FRAME SIZE	DISC NPT (in)	SUCT NPT (in)	A	AB	B	CP	D	DD	E	F	G	H	L	X	Y	Z
1 Phase	3 Phase																		
104GA6-1 1/2	3104GA6-1 1/2	1	143JM	1 1/2	2	178	227	127	402	109	89	70	51	9.5	9	244	121	65	97
15GA6-1 1/2	315GA6-1 1/2	1 1/2	143JM			178	227	127	402	109	89	70	51	9.5	9	244	121	65	97
20GA6-1 1/2	320GA6-1 1/2	2	145JM			178	227	152	427	109	89	70	64	9.5	9	244	121	65	97
30GA6-1 1/2	330GA6-1 1/2	3	145JM			178	227	152	427	109	89	70	64	9.5	9	244	121	65	97
50GA6-1 1/2	350GA6-1 1/2	5	182JM			222	251	146	446	109	114	95	57	13	10	263	121	65	97
----	375GA6-1 1/2	7 1/2	184JM			222	251	171	471	109	114	95	70	13	10	263	121	65	97
104GA6-2	3104GA6-2	1	143JM	2	2 1/2	178	227	127	408	117	89	70	51	9.5	9	251	138	70	102
154GA6-2	3154GA6-2	1 1/2	145JM			178	227	152	433	117	89	70	64	9.5	9	251	138	70	102
30GA6-2	330GA6-2	3	145JM			178	227	152	433	117	89	70	64	9.5	9	251	138	70	102
50GA6-2	350GA6-2	5	182JM			222	251	146	452	117	114	95	57	13	10	270	138	70	102
----	375GA6-2	7 1/2	184JM			222	251	171	478	117	114	95	70	13	10	270	138	70	102
30GA7-1 1/4	330GA7-1 1/4	3	145JM			1 1/4	1 1/2	178	227	152	443	89	114	70	64	9.5	8.7	260	143
50GA7-1 1/4	350GA7-1 1/4	5	182JM	222	251			146	462	114	114	95	57	12.7	10.3	279	143	84	103
----	375GA7-1 1/4	7 1/2	184JM	222	251			172	487	114	114	95	70	12.7	10.3	279	143	84	103
104GA7-1 1/2	3104GA7-1 1/2	1	143JM	1 1/2	2	178	227	127	419	89	116	70	51	9.5	8.7	262	152	84	108
154GA7-1 1/2	3154GA7-1 1/2	1 1/2	145JM			178	227	152	445	89	116	70	64	9.5	8.7	262	152	84	108
50GA7-1 1/2	----	5	184JM			229	251	171	489	114	116	95	70	13	10	281	152	84	108
----	350GA7-1 1/2	5	182JM			229	251	146	463	114	116	95	57	13	10	281	152	84	108
75GA7-1 1/2	----	7 1/2	213JM			267	281	184	527	133	116	108	70	16	10	303	152	84	108
----	375GA7-1 1/2	7 1/2	184JM			229	251	171	489	114	116	95	70	13	10	281	152	84	108
----	3100GA7-1 1/2	10	213JM	267	281	184	527	133	116	108	70	16	10	303	152	84	108		

DIMENSIONS SHOWN ABOVE ARE APPROXIMATE MAXIMUM DIMENSIONS FOR STANDARD PUMPS EQUIPPED WITH ODP MOTORS.

Close Coupled End Suction

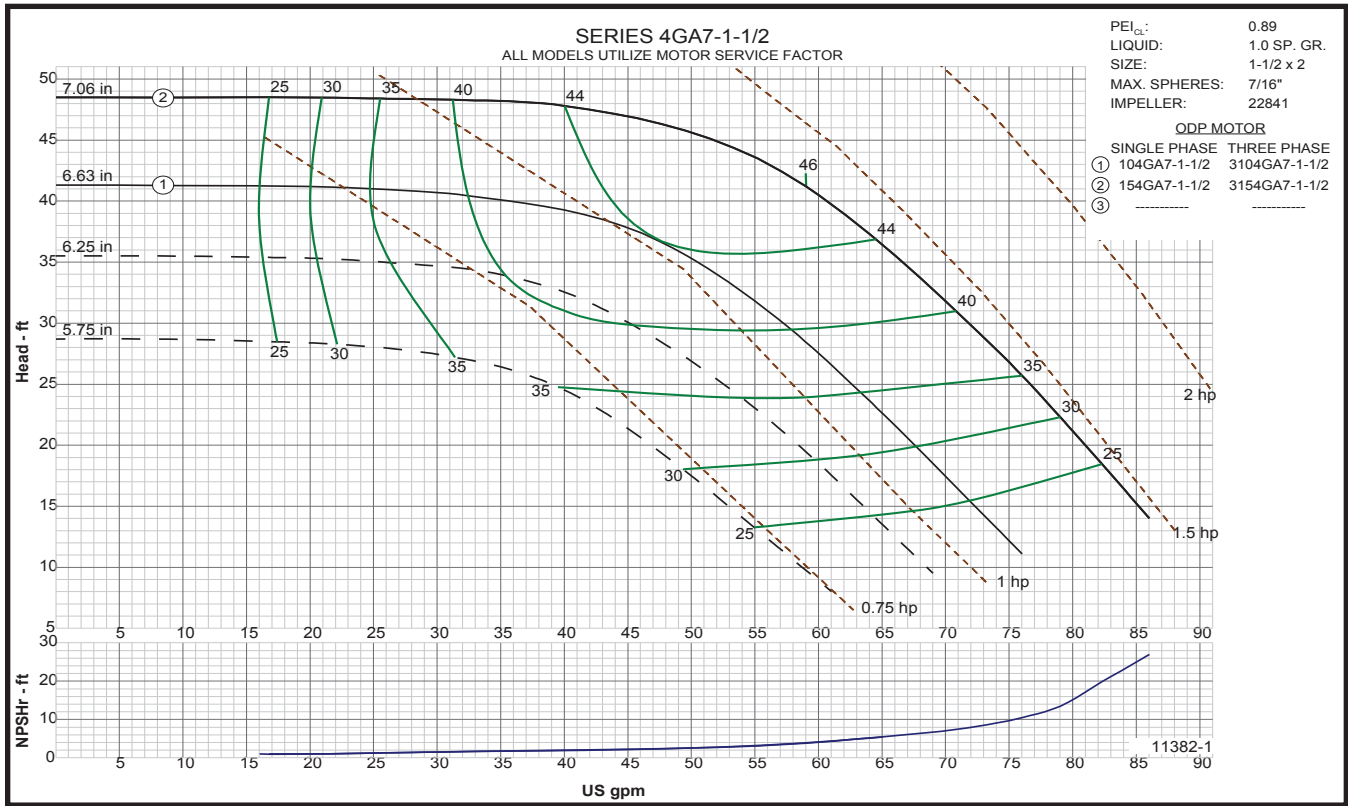

1750
RPM

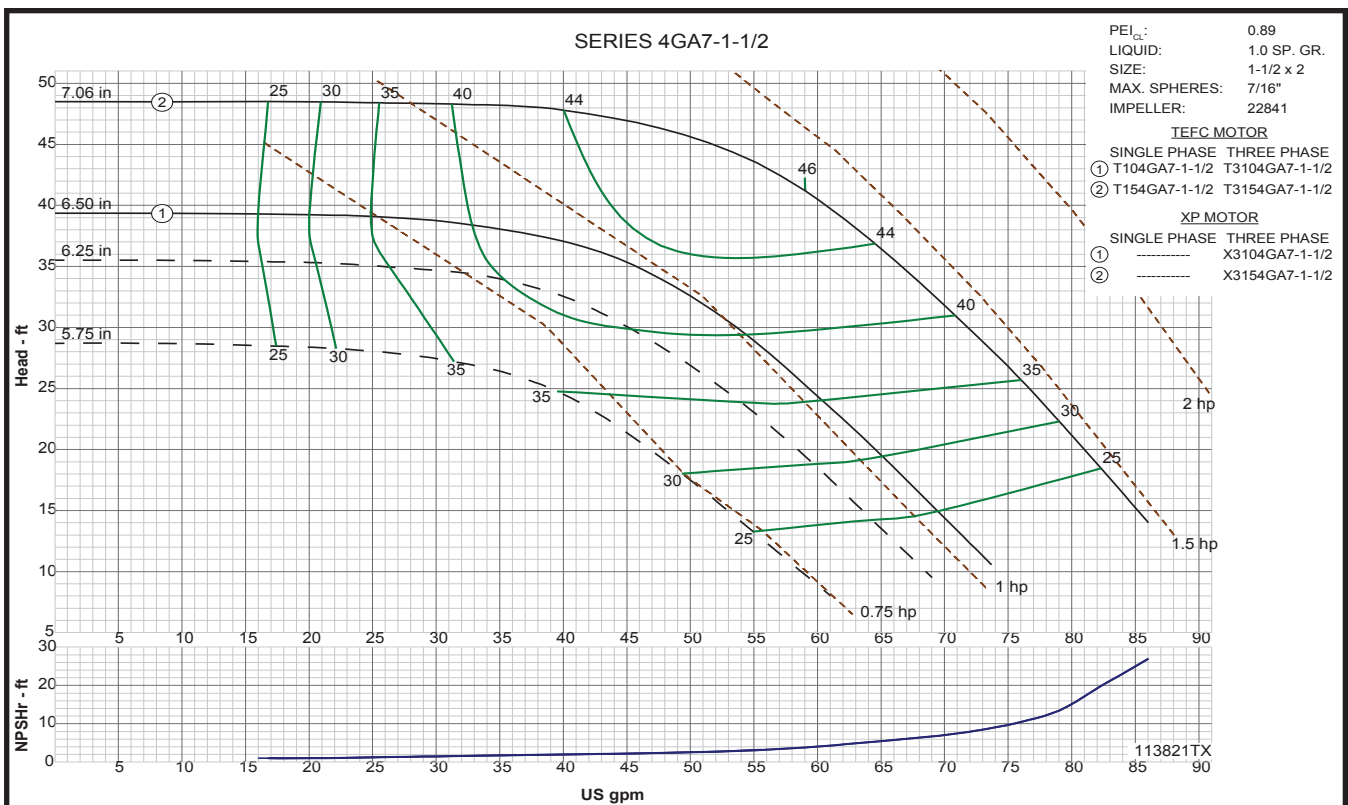

1750
RPM

60 Hz Performance

Close Coupled End Suction

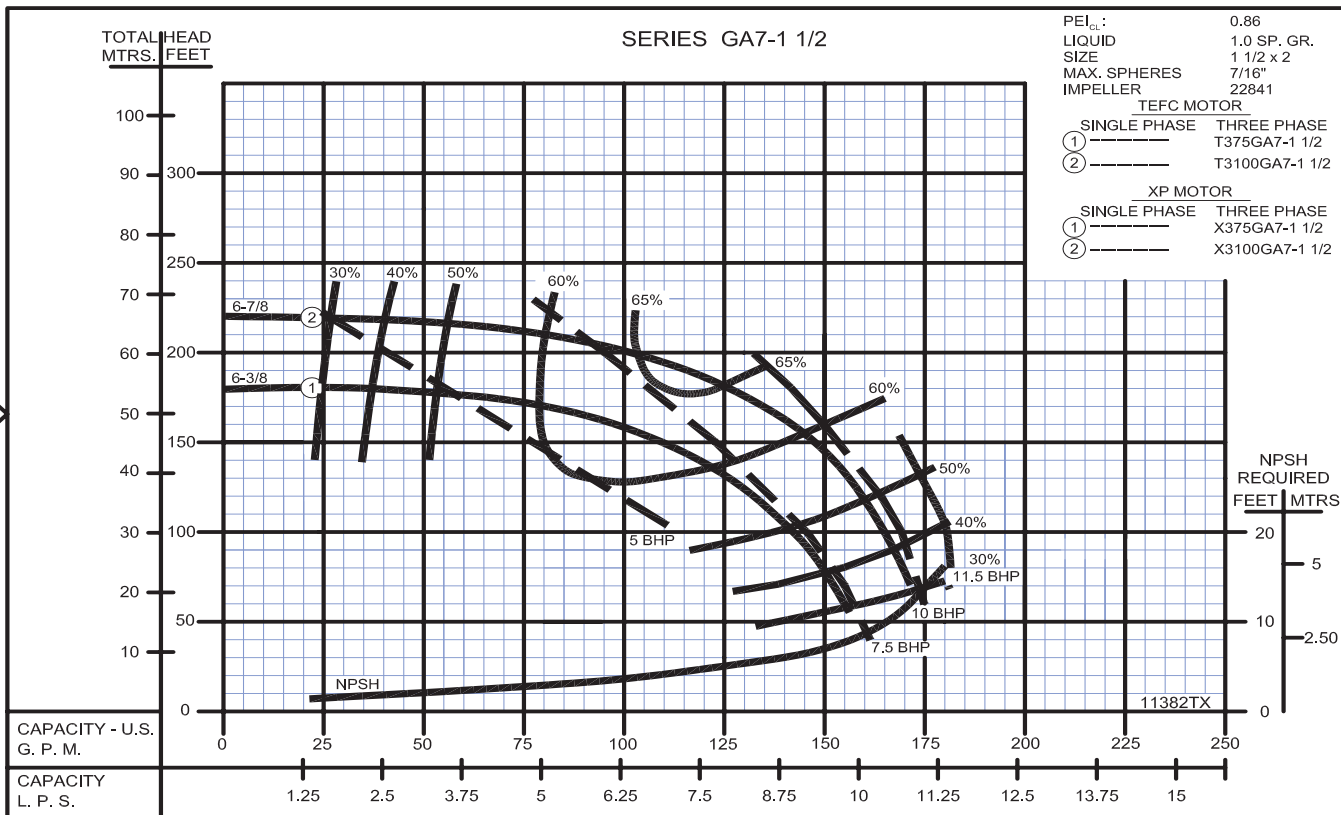
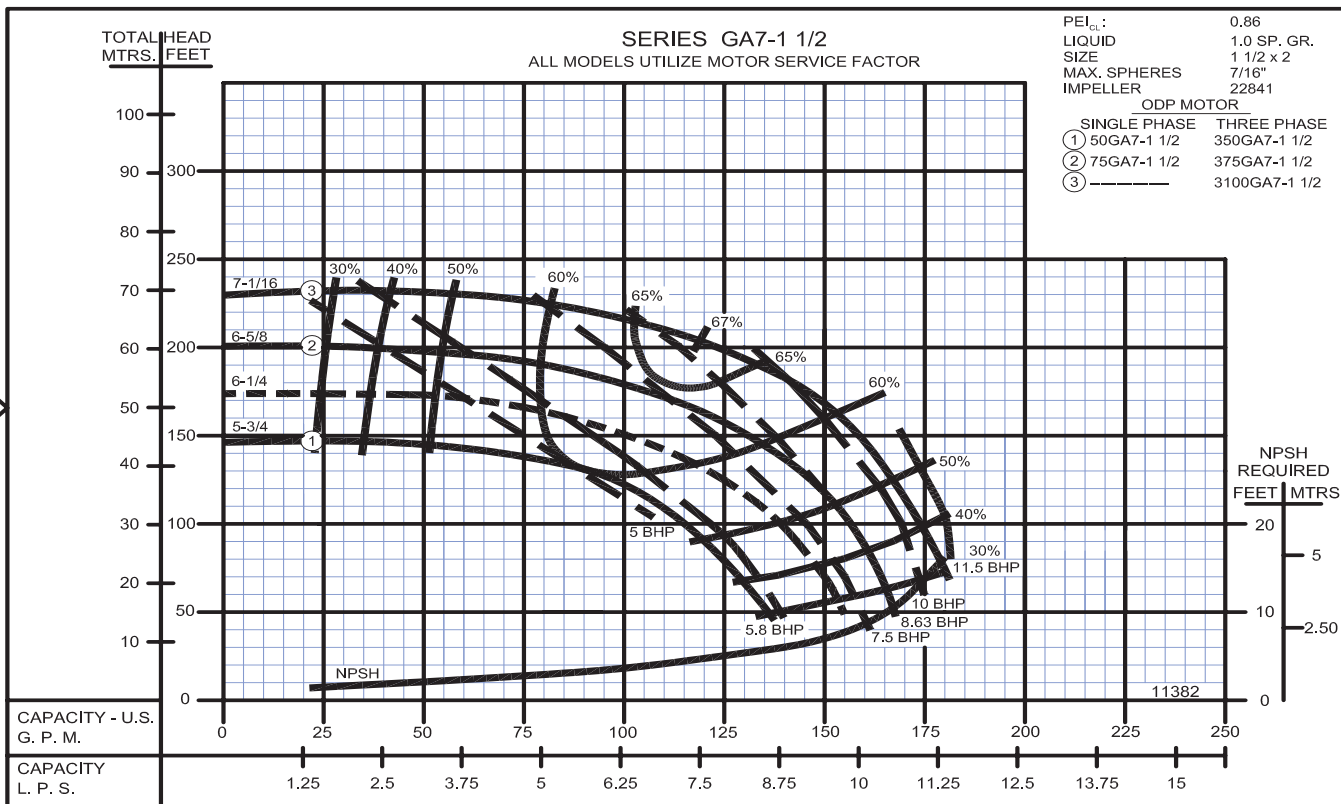

Centrifugals - Close Coupled

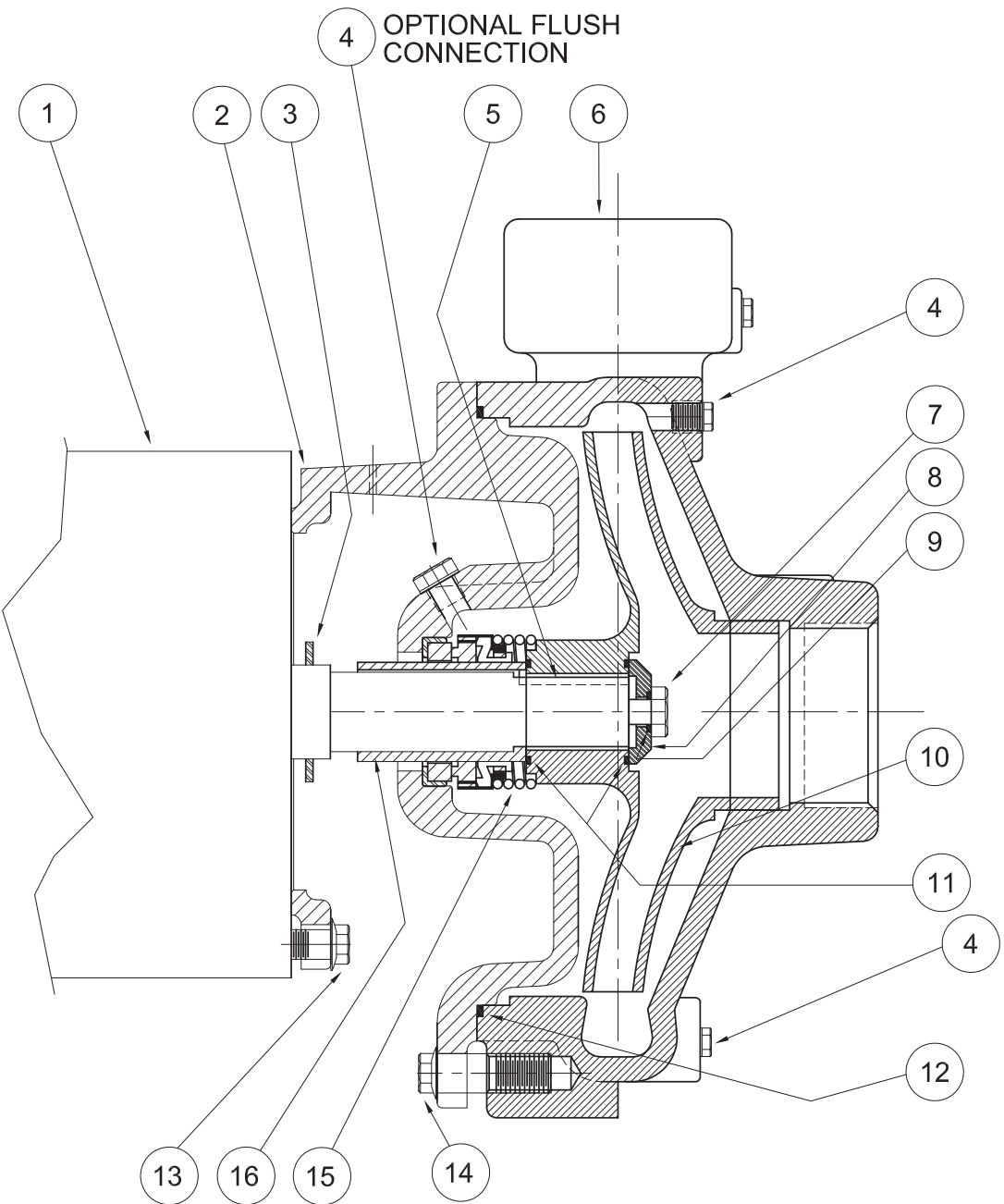

1 - MOTORS			
RPM & PHASE	PART NUMBER	HP	FRAME SIZE
OPEN DRIP PROOF			
1750 RPM Single Phase (ODP)	21393	1	143JM
	21394	1½	145JM
1750 RPM Three Phase (ODP)	21419	1	143JM
	21420	1½	145JM
3500 RPM Single Phase (ODP)	09902	5	184JM
	21850	7½	213JM
3500 RPM Three Phase (ODP)	09906	5	182JM
	09907	7½	184JM
	09999	10	213JM
TOTALLY ENCLOSED			
1750 RPM Single Phase (TEFC)	21399	1	143JM
	21400	1½	145JM
1750 RPM Three Phase (TEFC)	21426	1	143JM
	21427	1½	145JM
3500 RPM Single Phase (TEFC)	22283	5	213JM
	23442	7½	215JM
3500 RPM Three Phase (TEFC)	09950	5	184JM
	09951	7½	213JM
	20000	10	215JM
EXPLOSION PROOF			
1750 RPM Three Phase (XP)	21433	1	143JM
	21434	1½	145JM
3500 RPM Three Phase (XP)	09954	5	184JM
	09955	7½	213JM
	20001	10	215JM

SYMBOL NUMBER	PART NUMBER	QTY	DESCRIPTION
13	21236	4	Cap Screw - 143-184JM Motors
14	22803	4	Cap Screw - 213-215JM Motors
	22803	4	Cap Screw
15	09917	1	Mechanical Seal - Buna-N (Std)
	09926	1	Mechanical Seal - Viton
	21271	1	Mechanical Seal - EPDM**
16	22063-C	1	Shaft Sleeve - Bronze
DIFFERING PARTS FOR ALL BRONZE CONSTRUCTION			
2	22294-A	1	Adapter - Bronze - 143-184JM Motors
	22845-A	1	Adapter - Bronze - 213-215JM Motors
4	01691-A	3	Pipe Plug 1/8" Bronze
6	22842-A	1	Casing - Bronze
7	03289	1	Cap Screw - Bronze
DIFFERING PARTS FOR ALL IRON CONSTRUCTION			
2	00158	3	Pipe Plug 1/8" Steel
8	22105-A	1	Washer - Steel
10	Not Available	1	Impeller
16	22063-A	1	Shaft Sleeve - SS

(**) For hot water or Caustic service.

SYMBOL NUMBER	PART NUMBER	QTY	DESCRIPTION
2	22294	1	Adapter - 143-184JM Motors
	22845	1	Adapter - 213-215JM Motors
3	09918	1	Slinger Washer
4	00158	2	Pipe Plug - 1/8" Steel, Zinc Plated
5	23014	1	Key
6	22842	1	Casing
7	1-529-1	1	Cap Screw - SS
8	22105-C	1	Washer - Bronze
9	22080	1	O-Ring Gasket - Buna-N (Std)
	2-31005-012	1	O-Ring Gasket - Viton
	22093	1	O-Ring Gasket - EPDM**
10	1750 RPM		
	22841-6.63	1	Impeller - 104GA7-1-1/2 & 3104GA7-1-1/2
	22841-7.06	1	Impeller - 154GA7-1-1/2 & 3154GA7-1-1/2
	3500 RPM		
	22841-5.75	1	Impeller - 50GA7-1-1/2 & 350GA7-1-1/2
	22841-6.63	1	Impeller - 75GA7-1-1/2 & 375GA7-1-1/2
	22841-7.06	1	Impeller - 3100GA7-1-1/2
11	22083	2	O-Ring Gasket - Buna-N (Std)
	22084	2	O-Ring Gasket - Viton
	22094	2	O-Ring Gasket - EPDM**
12	22321	1	O-Ring Gasket - Buna-N (Std)
	22322	1	O-Ring Gasket - Viton
	22324	1	O-Ring Gasket - EPDM**



WARNING:

CANCER AND REPRODUCTIVE HARM -
WWW.P65WARNINGS.CA.GOV