



SERIES

CS

PumpAgents.com
Wholesale Pump Agents

CLOSE COUPLED TURBINE PUMPS

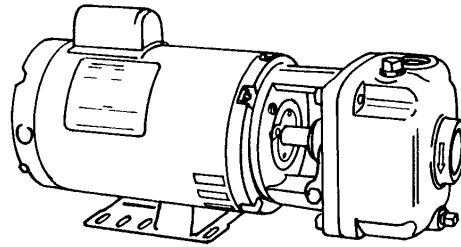

4CS- 1725 RPM - 60Hz.

CS - 3450 RPM - 60Hz.

(See Individual curves for symbol number)

CS - 2900 RPM - 50Hz.

(See Individual curves for symbol number)

* MAXIMUM HEAD			
Symbol No.	H.P.	Catalog Number	
		1 - Phase	3 - Phase
1	1/3	34CS5M	334CS5M
2	1/3	34CS6M	334CS6M
3	1/2	54CS6M	354CS6M
4	1/3	34CS7M	334CS7M
5	1/2	54CS7M	354CS7M
6	1/2	54CS8M	354CS8M
7	1	10CS5M	310CS5M
8	1 1/2	15CS5M	315CS5M
9	1	10CS6M	310CS6M
10	1 1/2	15CS6M	315CS6M
11	2	20CS6M	320CS6M
12	1 1/2	15CS7M	315CS7M
13	2	20CS7M	320CS7M
14	3	---	330CS7M
15	2	20CS8M	320CS8M
16	3	---	330CS8M
17	5	---	350CS8M
18	3	---	330CS9M
19	5	---	350CS9M

MAXIMUM HEAD		
Symbol No.	H.P.	Catalog Number
* 1	2.0	L320CS9M
2	2.6	L330CS9M
3	4.0	L340CS9M
4	1.5	L315CS8M
* 5	2.0	L320CS8M
6	2.6	L330CS8M
7	1.5	L315CS7M
* 8	2.0	L320CS7M
9	2.6	L330CS7M
10	1.0	L310CS6M
11	1.5	L315CS6M
* 12	2.0	L320CS6M
13	1.0	L310CS5M
14	1.0	L315CS5M

* Pump numbers 1, 5, 8 & 12 are the only pumps available in single phase 115/230 volt.

All of the pump above are available with stuffing box.

* For Standard Pumps with ODP Motors

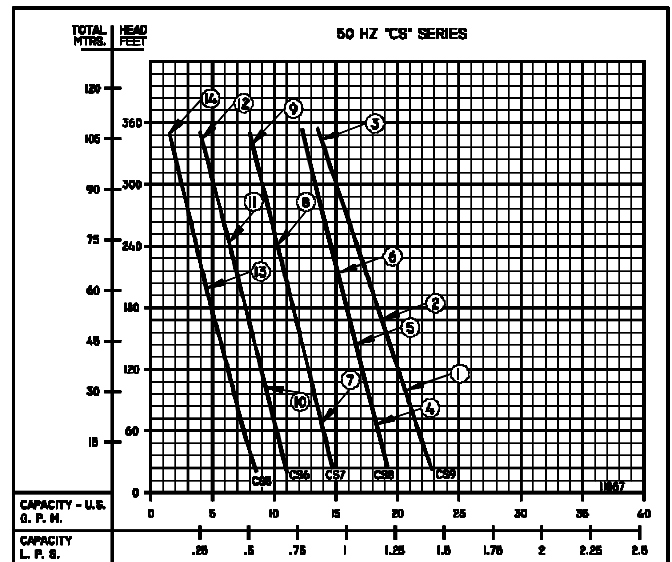
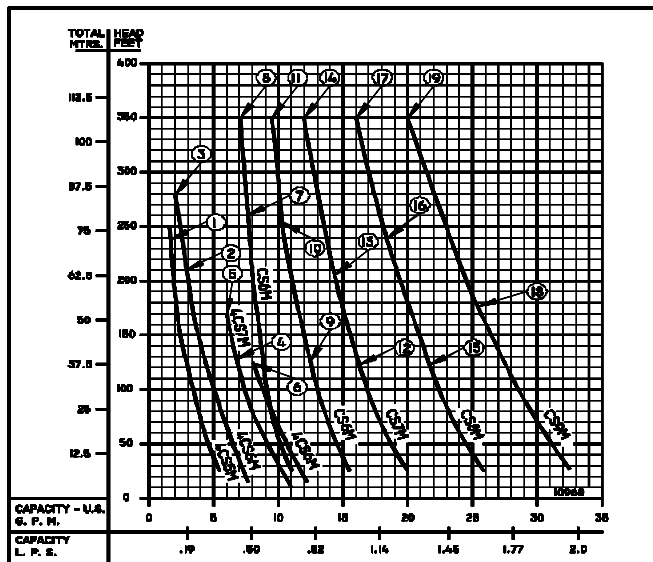

PUMPS & SYSTEMS

A Crane Co. Company

CLOSE COUPLED TURBINE PUMPS

60 HZ - PERFORMANCE & SELECTION CHART																			
Catalog Number		HP	Tappings		PSI FEET	TOTAL HEAD													
			Suct. NPT (in)	Disch. NPT (in)		8.6 20	17.2 40	26 60	43.3 100	54.1 125	64.9 150	75.8 175	86.6 200	97.4 225	108.3 250	119.1 275	130 300	140.1 325	151.6 350
1-Phase	3-Phase	CAPACITY IN G.P.M.																	
1750 RPM	34CS5M	334CS5M	1/3	1 1/4	1	5.8	4.9	4.3	3.3	2.8	2.4	2.1	1.8	1.6					
	34CS6M	334CS6M	1/3			7.8	6.9	6.3	5.2	4.6	4.1	3.7	3.3						
	54CS6M	354CS6M	1/2			7.8	6.9	6.3	5.2	4.6	4.1	3.7	3.3	2.9	2.6	2.3			
	34CS7M	334CS7M	1/3			10.4	9.4	8.5	7.2	6.5									
	54CS7M	354CS7M	1/2			10.4	9.4	8.5	7.2	6.5	5.9	5.4							
54CS8M	354CS8M	1/2																	
3450 RPM	10CS5M	310CS5M	1	1 1/4	1	11	10.6	10.1	9.3	9	8.5	8.2	8	7.7					
	15CS5M	315CS5M	1 1/2			11	10.6	10.1	9.3	9	8.5	8.2	8	7.7	7.5	7.4	7.2	7.1	
	10CS6M	310CS6M	1			16	15.2	14.5	13.5	12.8									
	15CS6M	315CS6M	1 1/2			16	15.2	14.5	13.5	12.8	12.4	12	11.5	11	10.7				
	20CS6M	320CS6M	2			16	15.2	14.5	13.5	12.8	12.4	12	11.5	11	10.7	10.5	10.1	9.7	9.5
	15CS7M	315CS7M	1 1/2			20.5	19.6	19.5	17.3										
	20CS7M	320CS7M	2			20.5	19.6	19.5	17.3	16.5	16	15.3	14.7						
	---	330CS7M	3			20.5	19.6	19.5	17.3	16.5	16	15.3	14.7						
	20CS8M	320CS8M	2			26.5	25.5	24.6	23	22									
	---	330CS8M	3			26.5	25.5	24.6	23	22	21.3	20.5	19.8	19.2					
	---	350CS8M	5			26.5	25.5	24.6	23	22	21.3	20.5	19.8	19.2	18.5	18	17.4	16.8	16.3
	---	330CS9M	3			32.5	31.5	30.5	28.6	27.5	26.5								
---	350CS9M	5	32.5	31.5	30.5	28.6	27.5	26.5	25.6	24.7	23.8	23	22.2	21.5	20.7	20			

60 HZ - PERFORMANCE & SELECTION CHART																			
Catalog Number		HP	Tappings		kPa Meters	TOTAL HEAD													
			Suct. NPT (in)	Disch. NPT (in)		59 6.1	119 12.1	179 18.2	299 30.5	373 38.1	447 45.7	523 53.3	597 61.0	672 68.6	747 76.2	821 83.8	896 91.4	966 99.1	1045 106.6
1-Phase	3-Phase	CAPACITY IN L.P.S.																	
1750 RPM	34CS5M	334CS5M	1/3	1 1/4	1	0.36	0.30	0.27	0.20	0.17	0.15	0.13	0.11	1.6					
	34CS6M	334CS6M	1/3			0.49	0.43	0.39	0.32	0.29	0.25	0.23	0.20						
	54CS6M	354CS6M	1/2			0.49	0.43	0.39	0.32	0.29	0.25	0.23	0.20	0.18	0.16	0.14			
	34CS7M	334CS7M	1/3			0.65	0.59	0.53	0.45	0.41									
	54CS7M	354CS7M	1/2			0.65	0.59	0.53	0.45	0.41	0.37	0.34							
54CS8M	354CS8M	1/2																	
3450 RPM	10CS5M	310CS5M	1	1 1/4	1	0.69	0.66	0.63	0.58	0.56	0.53	0.51	0.50	0.48					
	15CS5M	315CS5M	1 1/2			0.69	0.66	0.63	0.58	0.56	0.53	0.51	0.50	0.48	0.47	0.46	0.45	0.44	
	10CS6M	310CS6M	1			1.00	0.95	0.91	0.85	0.80									
	15CS6M	315CS6M	1 1/2			1.00	0.95	0.91	0.85	0.80	0.78	0.75	0.72	0.69	0.67				
	20CS6M	320CS6M	2			1.00	0.95	0.91	0.85	0.80	0.78	0.75	0.72	0.69	0.67	0.66	0.63	0.61	0.59
	15CS7M	315CS7M	1 1/2			1.29	1.24	1.23	1.09										
	20CS7M	320CS7M	2			1.29	1.24	1.23	1.09	1.04	1.00	0.96	0.92						
	---	330CS7M	3			1.29	1.24	1.23	1.09	1.04	1.00	0.96	0.92	0.89	0.86	0.83	0.80	0.78	0.75
	20CS8M	320CS8M	2			1.67	1.60	1.55	1.45	1.38									
	---	330CS8M	3			1.67	1.60	1.55	1.45	1.38	1.34	1.29	1.24	1.21					
	---	350CS8M	5			1.67	1.60	1.55	1.45	1.38	1.34	1.29	1.24	1.21	1.16	1.13	1.09	1.05	1.02
	---	330CS9M	3			2.05	1.98	1.92	1.80	1.73	1.67								
---	350CS9M	5	2.05	1.98	1.92	1.80	1.73	1.67	1.61	1.55	1.50	1.45	1.40	1.35	1.30	1.26			

NOTE: When pumping hot water over 180°F (82.2°C), check the NPSH available in the pumping system against the required pump NPSH shown on pump performance curves. Available NPSH must be greater than required NPSH.

FEATURES

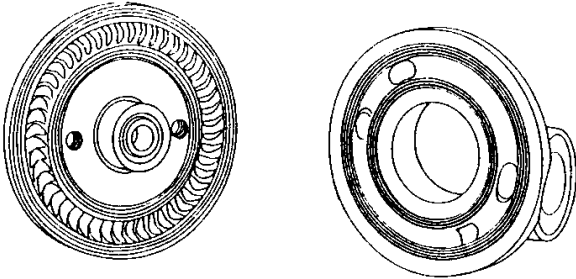

BURKS exclusive unique regenerative type turbine pumps are designed to handle clear water and many other non-abrasive, lower viscosity liquids on high pressure, low capacity applications with the greatest possible efficiency.

BURKS is the only turbine pump with Life-Lok ® External Impeller Adjustment feature that allows readjustment of impeller without disturbing piping, disassembling pump or replacing parts. Gives up to 40% longer service life than turbine pumps of other designs.

- Self-Priming
- Compact, Space-saving size
- No coupling - eliminates misalignment problems
- Dependable carbon/ceramic mechanical shaft seal for temperatures to 225°F (107°C).
- Bronze impeller with Monel blades - the only moving part
- Bronze raceway with cast-in vortex pockets - will not vapor lock
- #303 Stainless Steel pump shaft
- Easy to service
- Every pump factory tested
- Available Bronze fitted, All Bronze, Stainless Steel

MAXIMUM OPERATING CONDITIONS	
TEMPERATURE (For Standard Buna-N Seal)	225°F (107°C)
INLET PRESSURE	100 PSI (690kPa)
CASING WORKING PRESSURE	250 PSI (1723kPa)

MOTOR INFORMATION

4CS Series:

Single Phase motors are 115/208-230 Volt, 60Hz, 1750RPM

Three Phase motors are 208-230/460 Volts, 60/50Hz, 1750/1450RPM

CS Series:

Single Phase motors are 115/208-230 Volt, 60 Hz, 3450RPM

Three Phase 1, 1½ & 2HP. - 208-230/460 Volt, 60/50 Hz., 3450/2900 RPM

Three Phase 3 & 5 HP - 208-230/460 Volt, 60 Hz, 3450RPM

Standard pump motors have open drip proof construction and are rated with jet pump service factors for continuous duty operation at all ratings shown.

Single phase motors are capacitor start/induction run with built-in overload protection.

Three phase motors require a magnetic type starter which provides full 3-leg overload protection. Failure to use the correct starter and overloads will void the warranty.

FOR TEMPERATURES TO 500°F (260°C).

Series CS Pumps are available in a Jacketed Seal Cavity design for pumping hot oil, hot water and heat transfer fluids in common use in high temperature heating or cooling applications. This feature greatly extends seal life in high temperature applications. To order, add suffix "J" to pump catalog number for temperatures below 400°F (204°C) and add suffix "JK" to pump catalog number for temperatures over 400°F (204°). Example: 15CS5MJ. See Section on High Temperature Pumps for more information.

MATERIALS OF CONSTRUCTION			
PART	BRONZE FITTED	ALL BRONZE	STAINLESS STEEL
Frame	Cast Iron	Bronze	#316 Stainless
Case	Cast Iron	Bronze	#316 Stainless
Impeller	Bronze (Monel Blades)	Bronze (Monel Blades)	#303 Stainless
Raceway	Bronze	Bronze	#303 Stainless
Shaft	#303 Stainless	#303 Stainless	#303 Stainless
Shaft Seal	Carbon-Ceramic S. Steel-Buna-N	Carbon-Ceramic S. Steel-Buna-N	Carbon-Ceramic S. Steel-Buna-N



DIMENSIONS

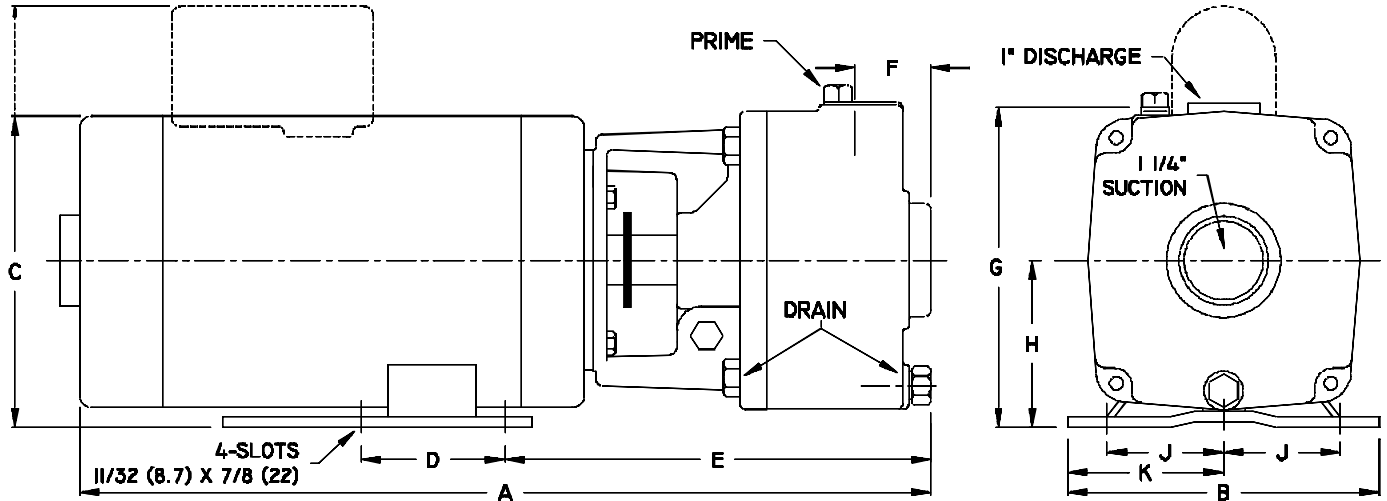

SERIES	HP	Tappings		DIMENSIONS IN INCHES											
		Disc. NPT (in)	Suct. NPT (in)	1 PH A	3 PH A	B	1 PH C	3 PH C	D	E	F	G	H	J	K
4CS	1/3	1 1/4	1	17 5/8	16 3/8	6 1/2	6 5/8	6 5/8	3	9	1 3/4	6 3/4	3 1/2	2 7/16	3 1/4
	1/2	1 1/4	1	17 5/8	16 5/8	6 1/2	6 5/8	6 5/8	3	9	1 3/4	6 3/4	3 1/2	2 7/16	3 1/4
CS	1	1 1/4	1	18 5/16	18 5/16	6 1/2	6 5/8	6 5/8	3	9	1 3/4	6 3/4	3 1/2	2 7/16	3 1/4
	1 1/2	1 1/4	1	19 1/16	19 1/16	6 1/2	8 13/16	6 5/8	3	9	1 3/4	6 3/4	3 1/2	2 7/16	3 1/4
	2	1 1/4	1	19 9/16	19 1/16	6 1/2	8 13/16	6 5/8	3	9	1 3/4	6 3/4	3 1/2	2 7/16	3 1/4
	3	1 1/4	1	---	19 9/16	6 1/2	---	6 5/8	3	9	1 3/4	6 3/4	3 1/2	2 7/16	3 1/4
	5	1 1/4	1	---	20 15/16	6 1/2	---	6 5/8	3	9	1 3/4	6 3/4	3 1/2	2 7/16	3 1/4

SERIES	HP	Tappings		DIMENSIONS IN MILLIMETERS											
		Disc. NPT (in)	Suct. NPT (in)	1 PH A	3 PH A	B	1 PH C	3 PH C	D	E	F	G	H	J	K
4CS	1/3	1 1/4	1	447	415	165	168	168	76	228	44	171	89	62	82
	1/2	1 1/4	1	447	422	165	168	168	76	228	44	171	89	62	82
CS	1	1 1/4	1	465	465	165	168	168	76	228	44	171	89	62	82
	1-1/2	1 1/4	1	484	484	165	223	168	76	228	44	171	89	62	82
	2	1 1/4	1	496	484	165	223	168	76	228	44	171	89	62	82
	3	1 1/4	1	---	496	165	---	168	76	228	44	171	89	62	82
	5	1 1/4	1	---	531	165	---	168	76	228	44	171	89	62	82

A strainer, approximately 20 mesh, should be installed on the suction side of the pump to prevent chips, scale or hard foreign particales from entering the pump and damaging the raceway and impeller.



PUMPS & SYSTEMS

A Crane Co. Company

CS SERIES CLOSE COUPLED TURBINE PUMPS

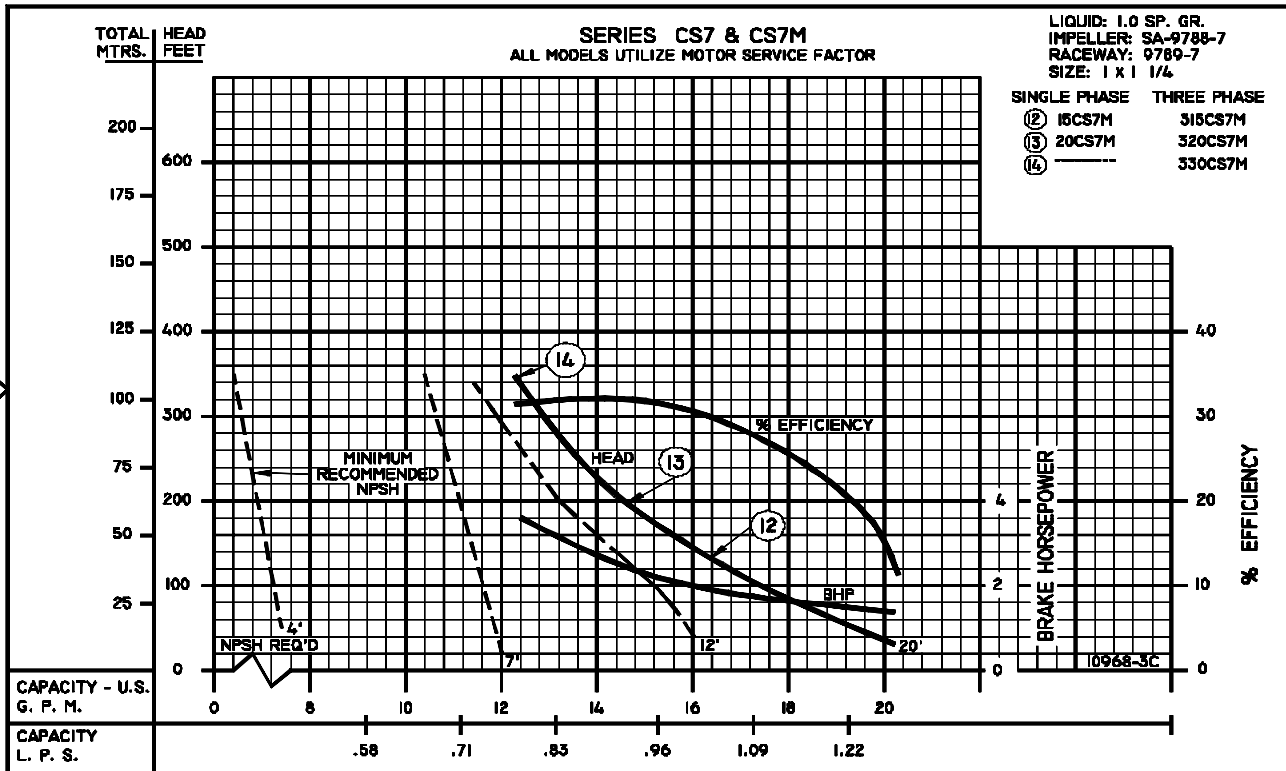
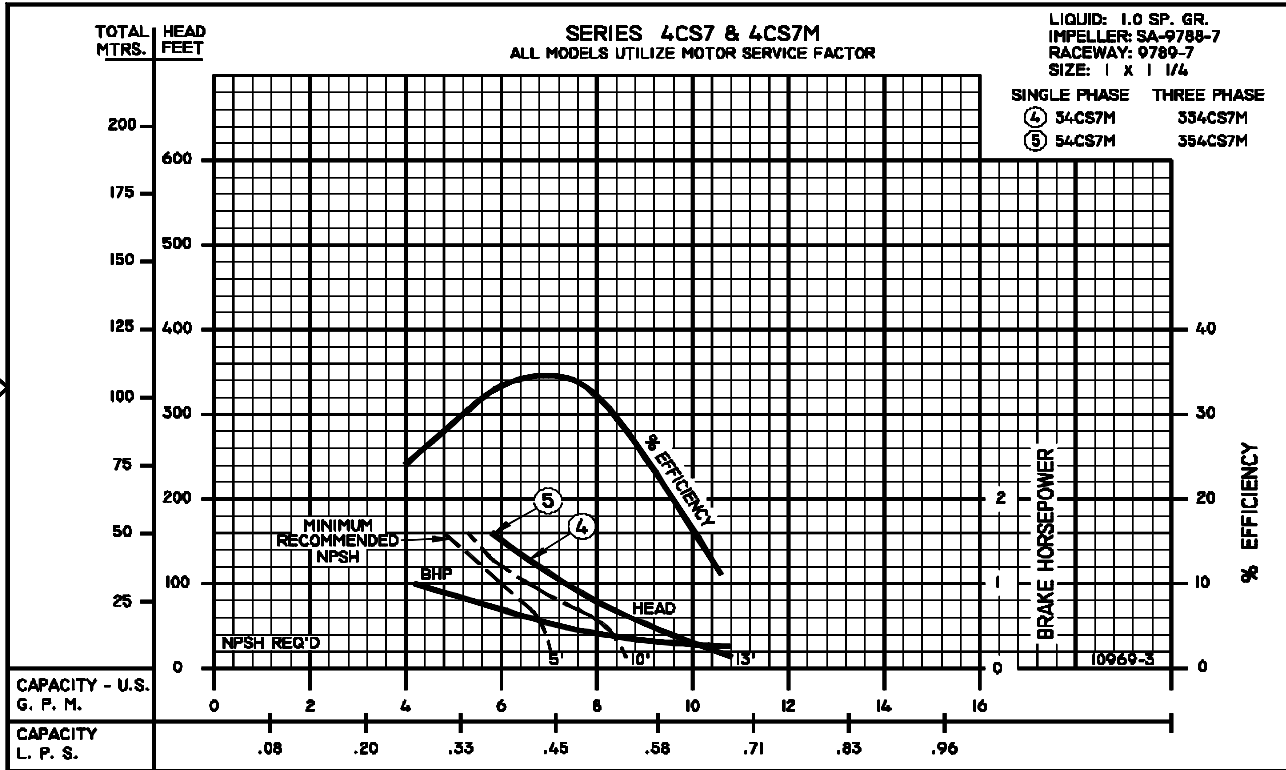

TCGP-76

1 - MOTORS		
RPM & PHASE	PART NUMBER	HP
1725 RPM - OPEN DRIP PROOF		
1725 RPM Single Phase (ODP)	09797	1/3
	09799	1/2
1725 RPM Three Phase (ODP)	09798	1/3
	09800	1/2
3450 RPM - OPEN DRIP PROOF		
3450 RPM Single Phase (ODP)	09805	1
	09807	1-1/2
	09809	2
3450 RPM Three Phase (ODP)	09806	1
	09808	1-1/2
	09810	2
	09812	3
	09855	5
3450 RPM - TOTALLY ENCLOSED		
3450 RPM Three Phase (TEFC)	09824	1-1/2
	09845	2
	09846	3

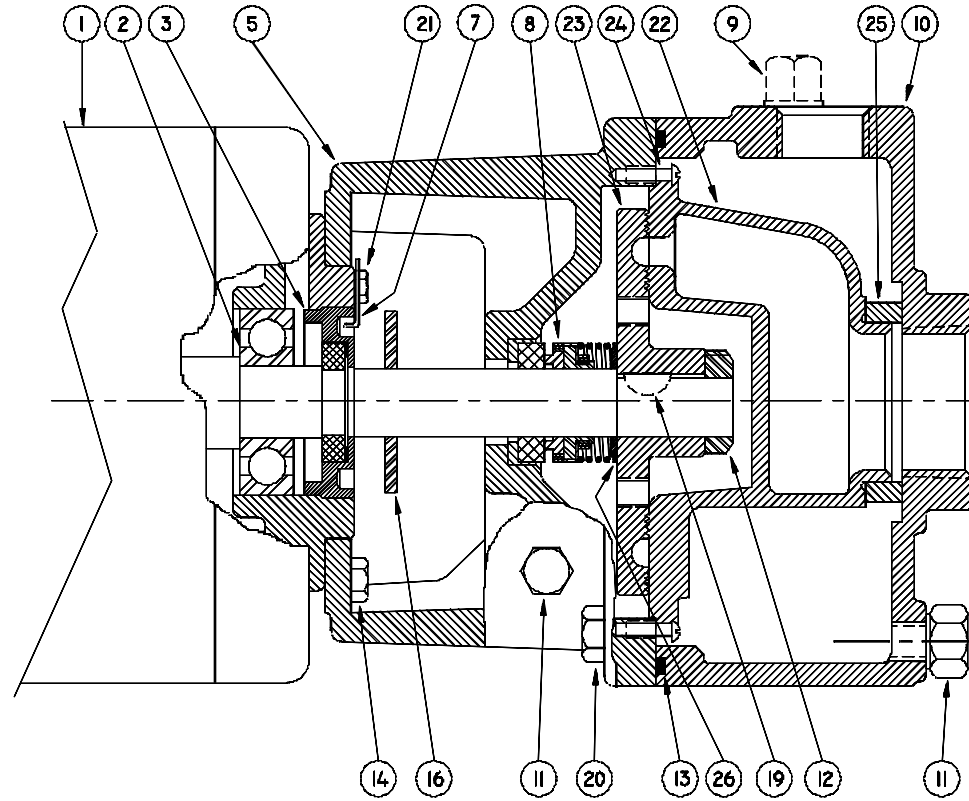

WITH MECHANICAL SEAL

WITH STUFFING BOX

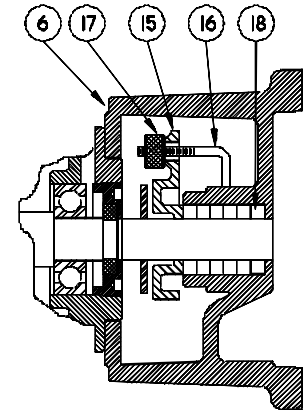

SERIES: CS - CLOSE COUPLED TURBINE PUMPS

File: CS.dwg

SYMBOL NUMBER	PART NUMBER	QUANTITY	DESCRIPTION
2	09144	1	Ball Bearing - Pump End
	05290	1	Ball Bearing - Switch End (Not Shown)
3	04206-A	1	Screw, Impeller Adjusting
4	08324	1	Slinger Washer
5	09787	1	Frame (for mechanical seal)
6	09792	1	Frame (for stuffing box)
7	07576	1	Adjusting Screw Lock
8	08991	1	Mechanical Seal - Buna N
	09813-C	1	Mechanical Seal - Viton
	21934	1	Mechanical Seal - EPT
9	02953	1	Plug, 1/2"
10	09790-B	1	Case
11	04236	2	Plug, 1/4-18 NPT
12	01404	1	Impeller Lock Nut
13	09791	1	O-Ring Gasket - Buna N
	09817	1	O-Ring Gasket - Viton
	22135	1	O-Ring Gasket - EPT
	22104	1	O-Ring Gasket - Teflon
14	03121	4	Screw, 1/4" x 3/4"
15	05812-B	1	Gland, Stuffing Box
16	07003	2	Gland Bolt
17	04211	2	Gland Nut
18	05468	5	Packing
19	01457	1	Key, Woodruff (As Shown) (Repair Kits Only)
	21748-A	1	Key, Square
20	01931	4	Screw, 7/16-14 x 1-1/4" Lg
21	07577	1	Screw, #10 x 3/8" Lg
22	09789-5	1	Raceway for CS5M
	09789-6	1	Raceway for CS6M
	09789-7	1	Raceway for CS7M
	09789-8	1	Raceway for CS8M
	09789-9	1	Raceway for CS9M

SYMBOL NUMBER	PART NUMBER	QUANTITY	DESCRIPTION
* 23	SA09788-5	1	Impeller for CS5M
	SA09788-6	1	Impeller for CS6M
	SA09788-7	1	Impeller for CS7M
	SA09788-HT-8	1	Impeller for CS8M
	SA09788-HT-9	1	Impeller for CS9M
24	02535	2	Screw, Raceway to Frame
25	04231	1	Suction Sleeve - Buna N (std)
	09695	1	Suction Sleeve - Viton
	20285	1	Suction Sleeve - EPT
DIFFERING PARTS FOR ALL BRONZE CONSTRUCTION			
5	09787-A	1	Frame (for mechanical seal)
6	09792-A	1	Frame (for stuffing box)
10	09790-C	1	Case
14	03121-B	4	Screw, 1/4 x 3/4" Lg
20	08771	4	Screw, 7/16-14 x 1-1/4" Lg., S.S.

REPAIR KITS for CT SERIES PUMPS	
CATALOG NO.	FOR USE WITH
20522-5	CS5M
20522-6	CS6M
20522-7	CS7M
20522-8	CS8M
20522-9	CS9M

Kit Includes: Impeller, Raceway, Shaft Seal, O-Ring Gasket, Suction Sleeve, Raceway Screws, Impeller Locknut, Shaft Key and instructions.

TCPP-77

SERIES: CS - CLOSE COUPLED TURBINE PUMPS

* Standard impellers are suitable for fluid temperatures to 250°F. For higher temperatures, add the designation "HT" to impeller part number.

This includes all "MJ" Jacketed Seal Pumps.

Example: SA-9788HT-5

For technical advice or service please take your pump into your local pump service center.
To order pump or parts or for pricing please go to the following links :

[Burks Pumps Home >>](#)

[Burks Pumps stock list >>](#)