

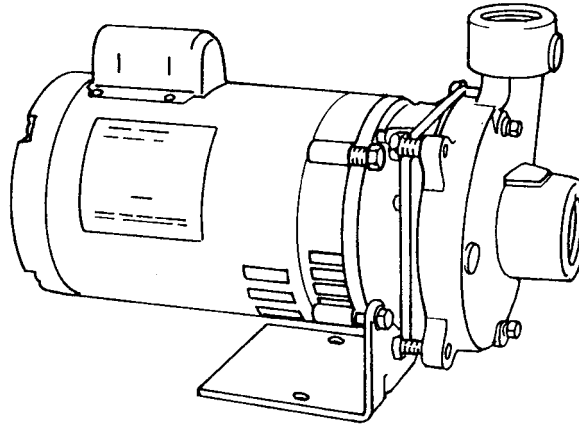

**SERIES: GA5-1  
GA5-1-1/4, GA5N-1-1/4  
GA6-1-1/4, GA6N-1-1/4**

SECTION	2A
PAGE	13
ISSUED	2/03
REPLACES	12/01

## CLOSED COUPLED CENTRIFUGAL PUMPS



**3500RPM - 60Hz.**  
CAPACITIES TO 100GPM (6.3LPS)  
HEADS TO 130 FEET (39.6M)

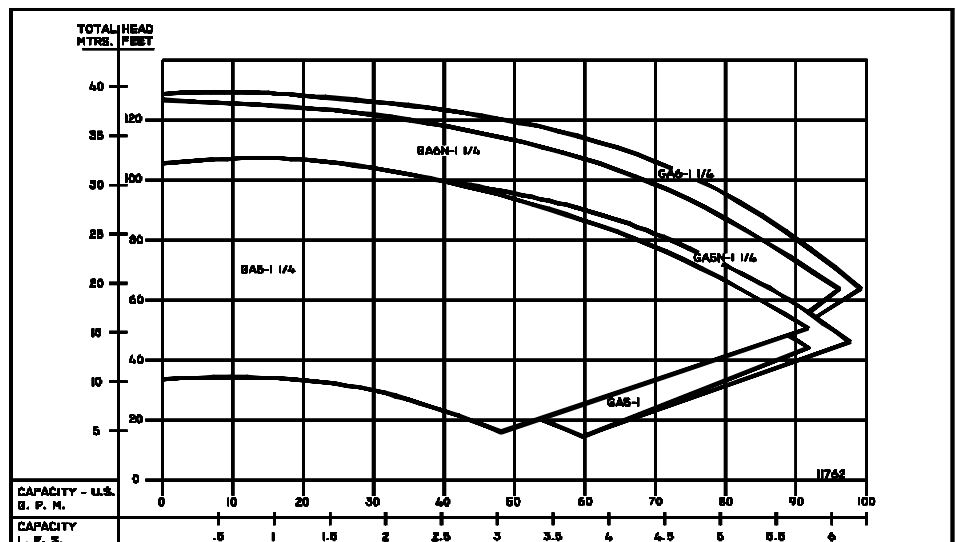

**2900RPM - 50Hz.**  
CAPACITIES TO 83GPM (5.2LPS)  
HEADS TO 89 FEET (27M)

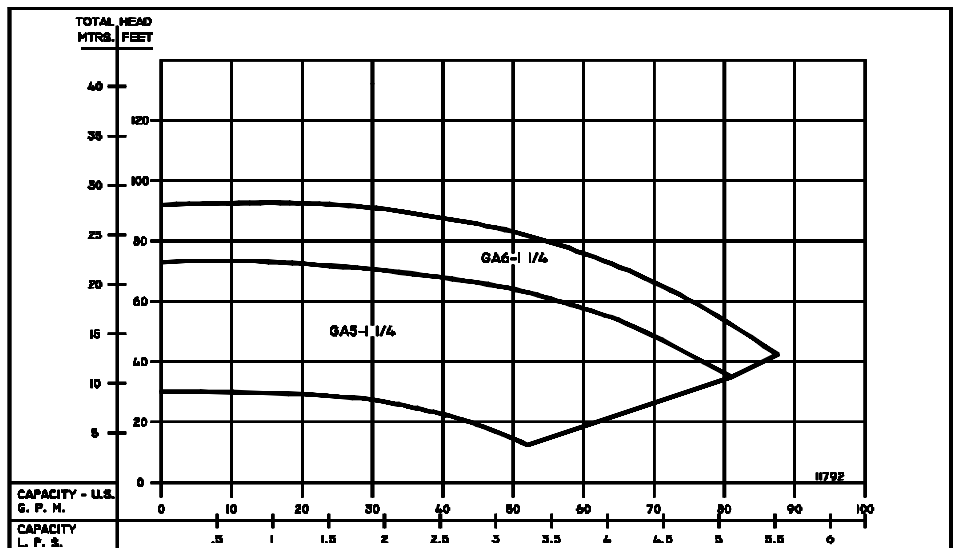

Individual performance curves should be checked for final selection.

SECTION	2A
PAGE	14
ISSUED	2/03
REPLACES	12/01



## FEATURES

- FOUR POSITION CASING**

Discharge can be located in any of four positions. Casing is close grain iron of 30,000 psi minimum tensile strength. Back pull-out design eliminates the need to disturb piping should the pump ever require service - the casing stays in the line.

- ENCLOSED BRONZE IMPELLER**

Of the latest hydraulic design for maximum efficiency, impeller is balanced for vibration-free operation and threaded onto stainless steel motor shaft.

- ENCLOSED GLASS FILLED NORYL® IMPELLER\***

Of the latest hydraulic design for maximum efficiency, impeller has molded in brass insert threaded onto stainless steel motor shaft. \*Noryl® Impeller is not designed for use with hydrocarbons.

- MECHANICAL SHAFT SEAL**

Standard self-adjusting shaft seal for temperatures to 225°F (107°C) and pressures to 150 psi (1034 kpa). Ceramic seat and carbon seal face for long trouble-free service. Special seals are available for higher temperatures and fluids other than water.

- MOTORS**

Standard pump motors are of open drip proof (ODP) construction and are rated with jet pump service factors for continuous duty operation. Motors are 56 frame size with NEMA standard mounting flange, one piece threaded stainless steel shaft and ball/ball bearing construction.

- FACTORY TESTED**

After careful assembly and inspection, **EVERY** pump is factory tested and meets Hydraulic Institute standards.

MAXIMUM OPERATING CONDITIONS		
TEMPERATURE (For Standard Buna-N Seal)	225°F (107°C) BRONZE	175°F (79°C) NORYL®
INLET PRESSURE	100 PSI (690 kpa)	
CASING WORKING PRESSURE	200 PSI (1379 kpa)	

### MOTOR INFORMATION

60 Hz - 3500 RPM - ODP

**Single Phase:** 1/3 thru 2 Hp. - 115/230 Volt  
3 Hp. - 230 Volt only

**Three Phase:** 1/3 thru 3 Hp. - 208-230/460 Volt  
50 Hz - 2900 RPM - ODP

**Single Phase:** 110/220 Volt

**Three Phase:** 380 Volt

Voltages may differ from some suppliers. Consult factory.

**Overload Protection:** All single phase ODP and Totally Enclosed motors have built-in overload protection. All three phase motors and all explosion proof motors must be installed with a magnetic starter which provides full 3-leg protection. Failure to use correct starter and overloads will void motor warranty.

### JACKETED SEAL CAVITY

#### FOR TEMPERATURES TO 500°F (260°C).

Series GA5-1 & GA5-1<sup>1</sup>/<sub>4</sub> Pumps are available in a Jacketed Seal Cavity design for pumping hot oil, hot water and heat transfer fluids in common use in high temperature heating or cooling applications. This feature greatly extends seal life in high temperature applications. To order, add suffix "MJ" to pump catalog number for temperatures to 500°F (260°C) See Section on High Temperature Pumps for more information.

## MATERIALS OF CONSTRUCTION

PART	ALL IRON	BRONZE FITTED	ALL BRONZE	NORYL® FITTED
Adapter	Cast Iron	Cast Iron	Bronze	Cast Iron
Casing	Cast Iron	Cast Iron	Bronze	Cast Iron
Shaft	#303 Stainless	#303 Stainless	#303 Stainless	#303 Stainless
Impeller	Cast Iron	Bronze	Bronze	Glass Filled Noryl
Shaft Seal	Carbon-Ceramic S. Steel-Buna-N	Carbon-Ceramic S. Steel-Buna-N	Carbon-Ceramic S. Steel-Buna-N	Carbon-Ceramic S. Steel-Buna-N



A Crane Co. Company

PUMPS & SYSTEMS

PumpAgents.com - buy pumps and parts online

## DIMENSIONS

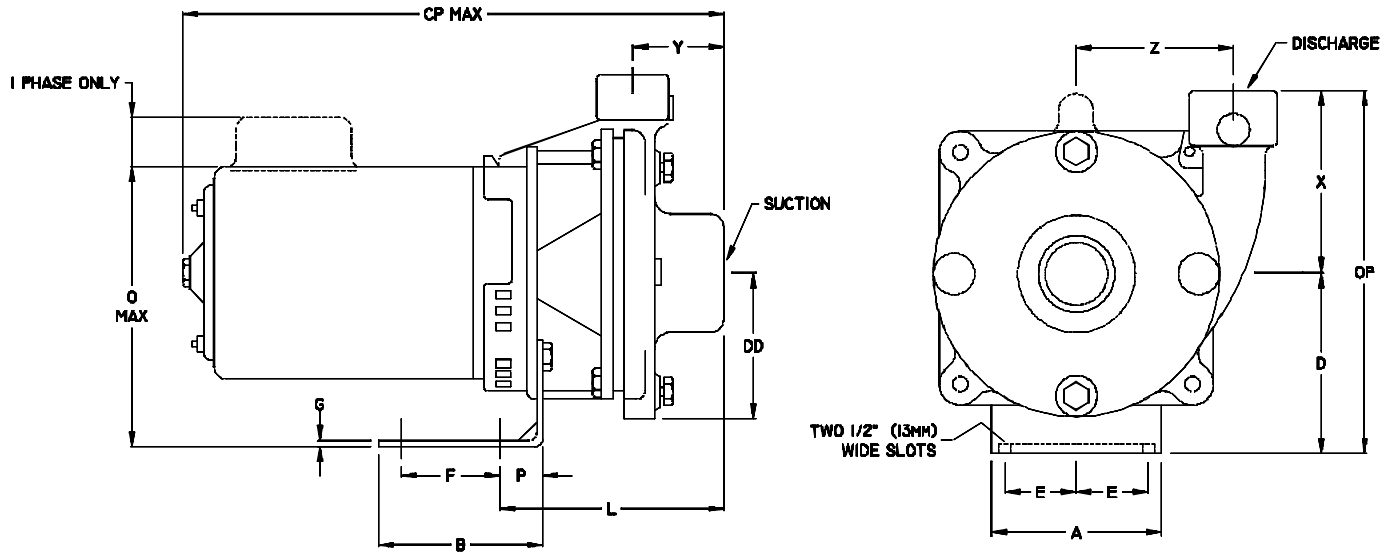

DIMENSIONS IN INCHES																		
CATALOG NUMBER	MOTOR FRAME SIZE	DISCH NPT	SUCT. NPT	A	B	CP	D	DD	E	F	G	L	O	OP	P	X	Y	Z
GA5-1	56	1	1 <sup>1</sup> / <sub>4</sub>	5 <sup>3</sup> / <sub>16</sub>	5	16 <sup>7</sup> / <sub>8</sub>	4 <sup>3</sup> / <sub>4</sub>	3 <sup>3</sup> / <sub>8</sub>	1 <sup>15</sup> / <sub>16</sub>	3	3 <sup>3</sup> / <sub>16</sub>	5 <sup>15</sup> / <sub>16</sub>	8 <sup>9</sup> / <sub>16</sub>	9 <sup>1</sup> / <sub>2</sub>	1 <sup>5</sup> / <sub>16</sub>	4 <sup>11</sup> / <sub>16</sub>	2 <sup>5</sup> / <sub>8</sub>	3 <sup>9</sup> / <sub>16</sub>
GA5-1 <sup>1</sup> / <sub>4</sub>	56	1 <sup>1</sup> / <sub>4</sub>	1 <sup>1</sup> / <sub>2</sub>	5 <sup>3</sup> / <sub>16</sub>	5	15 <sup>11</sup> / <sub>16</sub>	4 <sup>3</sup> / <sub>4</sub>	3 <sup>3</sup> / <sub>8</sub>	1 <sup>15</sup> / <sub>16</sub>	3	3 <sup>3</sup> / <sub>16</sub>	5 <sup>15</sup> / <sub>16</sub>	8 <sup>9</sup> / <sub>16</sub>	9 <sup>1</sup> / <sub>2</sub>	1 <sup>5</sup> / <sub>16</sub>	4 <sup>11</sup> / <sub>16</sub>	2 <sup>5</sup> / <sub>8</sub>	3 <sup>3</sup> / <sub>8</sub>
GA6-1 <sup>1</sup> / <sub>4</sub>	56	1 <sup>1</sup> / <sub>4</sub>	1 <sup>1</sup> / <sub>2</sub>	5 <sup>3</sup> / <sub>16</sub>	5	15 <sup>15</sup> / <sub>16</sub>	4 <sup>3</sup> / <sub>4</sub>	3 <sup>3</sup> / <sub>4</sub>	1 <sup>15</sup> / <sub>16</sub>	3	3 <sup>3</sup> / <sub>16</sub>	5 <sup>13</sup> / <sub>16</sub>	8 <sup>9</sup> / <sub>16</sub>	9 <sup>1</sup> / <sub>2</sub>	1 <sup>5</sup> / <sub>16</sub>	4 <sup>11</sup> / <sub>16</sub>	2 <sup>5</sup> / <sub>8</sub>	3 <sup>3</sup> / <sub>4</sub>

DIMENSIONS IN MILLIMETERS																		
CATALOG NUMBER	MOTOR FRAME SIZE	DISCH NPT	SUCT. NPT	A	B	CP	D	DD	E	F	G	L	O	OP	P	X	Y	Z
GA5-1	56	1	1 <sup>1</sup> / <sub>4</sub>	132	127	429	121	86	49	76	4.7	151	217	241	33	119	67	90
GA5-1 <sup>1</sup> / <sub>4</sub>	56	1 <sup>1</sup> / <sub>4</sub>	1 <sup>1</sup> / <sub>2</sub>	132	127	398	121	86	49	76	4.7	151	217	241	33	119	67	86
GA6-1 <sup>1</sup> / <sub>4</sub>	56	1 <sup>1</sup> / <sub>4</sub>	1 <sup>1</sup> / <sub>2</sub>	132	127	398	121	95	49	76	4.7	148	217	241	33	119	67	95

DIMENSIONS SHOWN ABOVE ARE APPROXIMATE MAXIMUM DIMENSIONS FOR STANDARD PUMPS EQUIPPED WITH ODP MOTORS.  
Noryl option specifications same as above.  
©Noryl is a registered trademark of General Electric.



60HZ  
PERFORMANCE CURVE

SECTION	2A
PAGE	19
ISSUED	2/03
REPLACES	12/01

END SUCTION CENTRIFUGAL PUMPS

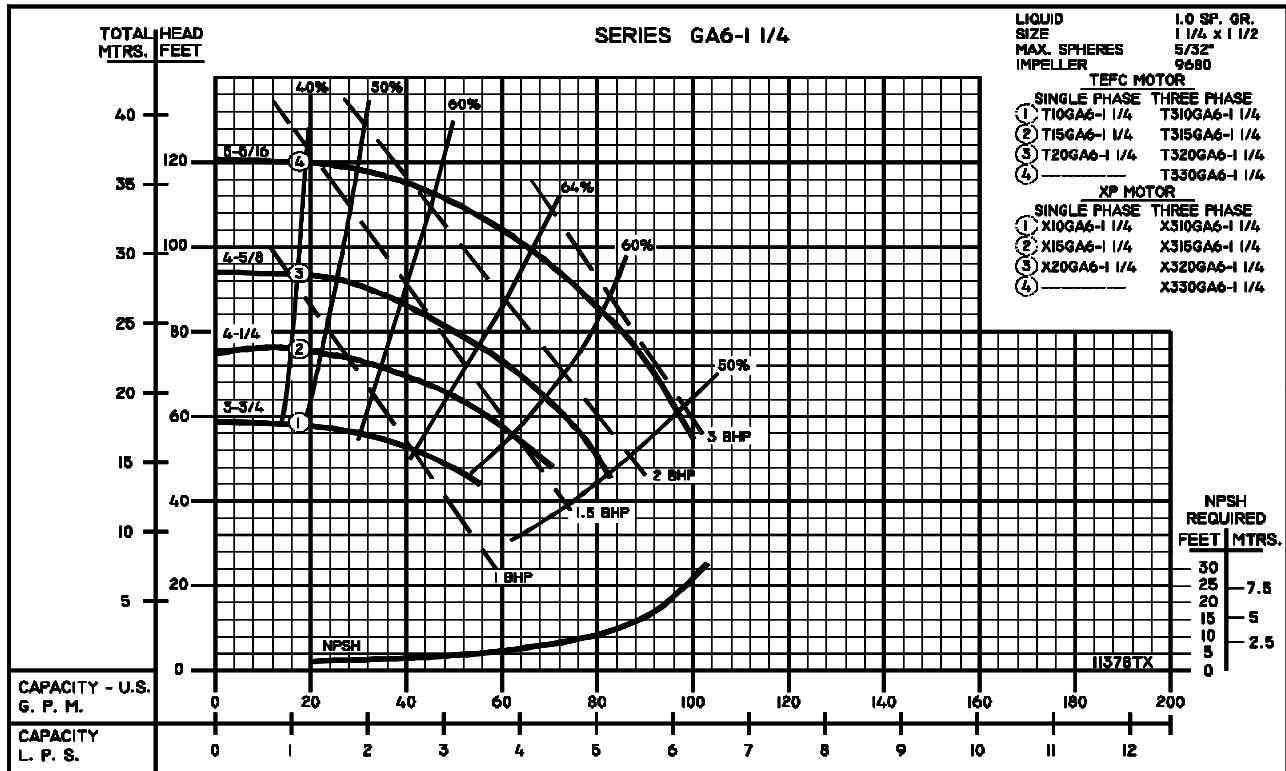
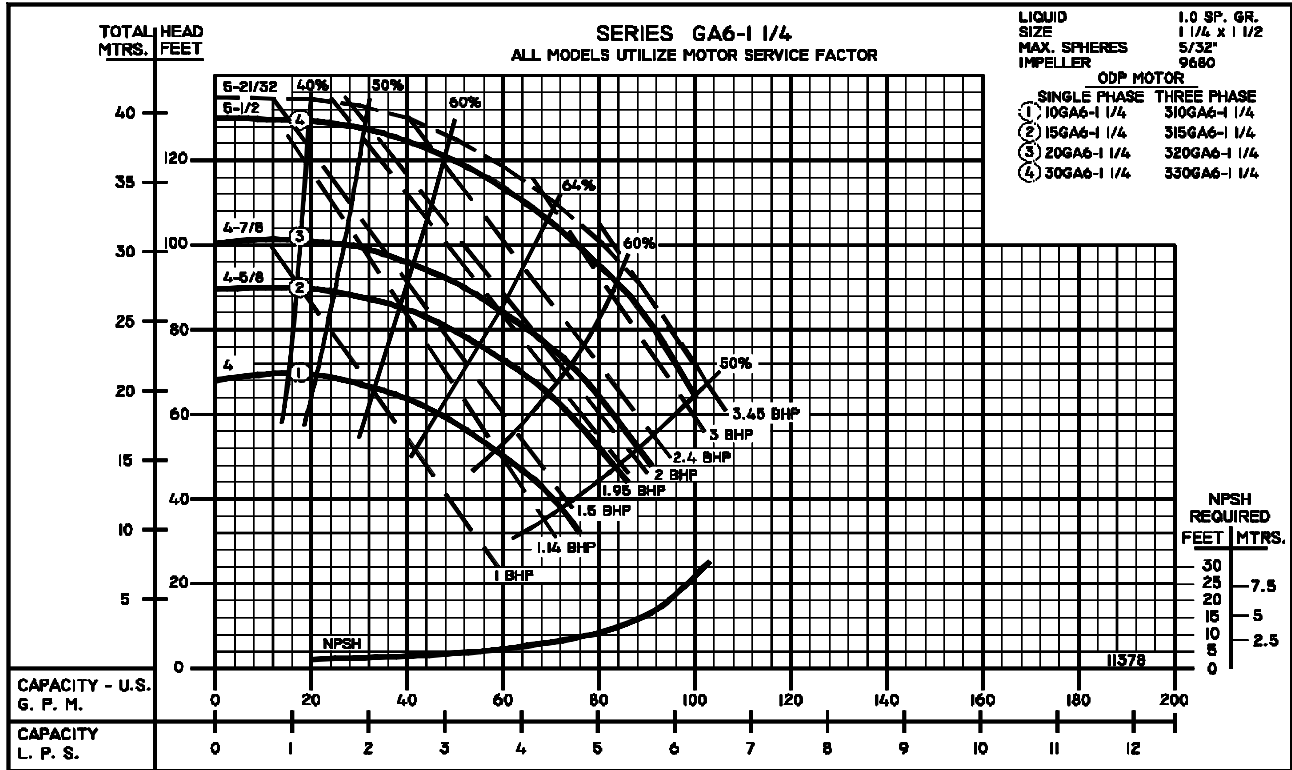

CCCP-6

1 - MOTORS (All 56J Frame)		
RPM & PHASE	PART NUMBER	HP
<b>OPEN DRIP PROOF</b>		
3500 RPM Single Phase (ODP)	09581	1/3
	09582	1/2
	09625	3/4
	09650	1
	09675	1-1/2
	09677	2
	09737	3
3500 RPM Three Phase (ODP)	09661	1/3
	09662	1/2
	09652	3/4
	09653	1
	09676	1-1/2
	09678	2
	09738	3
<b>TOTALLY ENCLOSED</b>		
3500 RPM Single Phase (TENV / TEFC)	09688	1/2
	09690	3/4
	09692	1
	09774	1-1/2
	09827	2
3500 RPM Three Phase (TENV / TEFC)	09689	1/2
	09691	3/4
	09693	1
	09758	1-1/2
	09829	2
	21697	3
<b>EXPLOSION PROOF</b>		
3500 RPM Single Phase (XP)	20655	1/2
	20513	3/4
	20515	1
	20517	1-1/2
	20519	2
3500 RPM Three Phase (XP)	20656	1/2
	20514	3/4
	20516	1
	20518	1-1/2
	20520	2
	09909	3

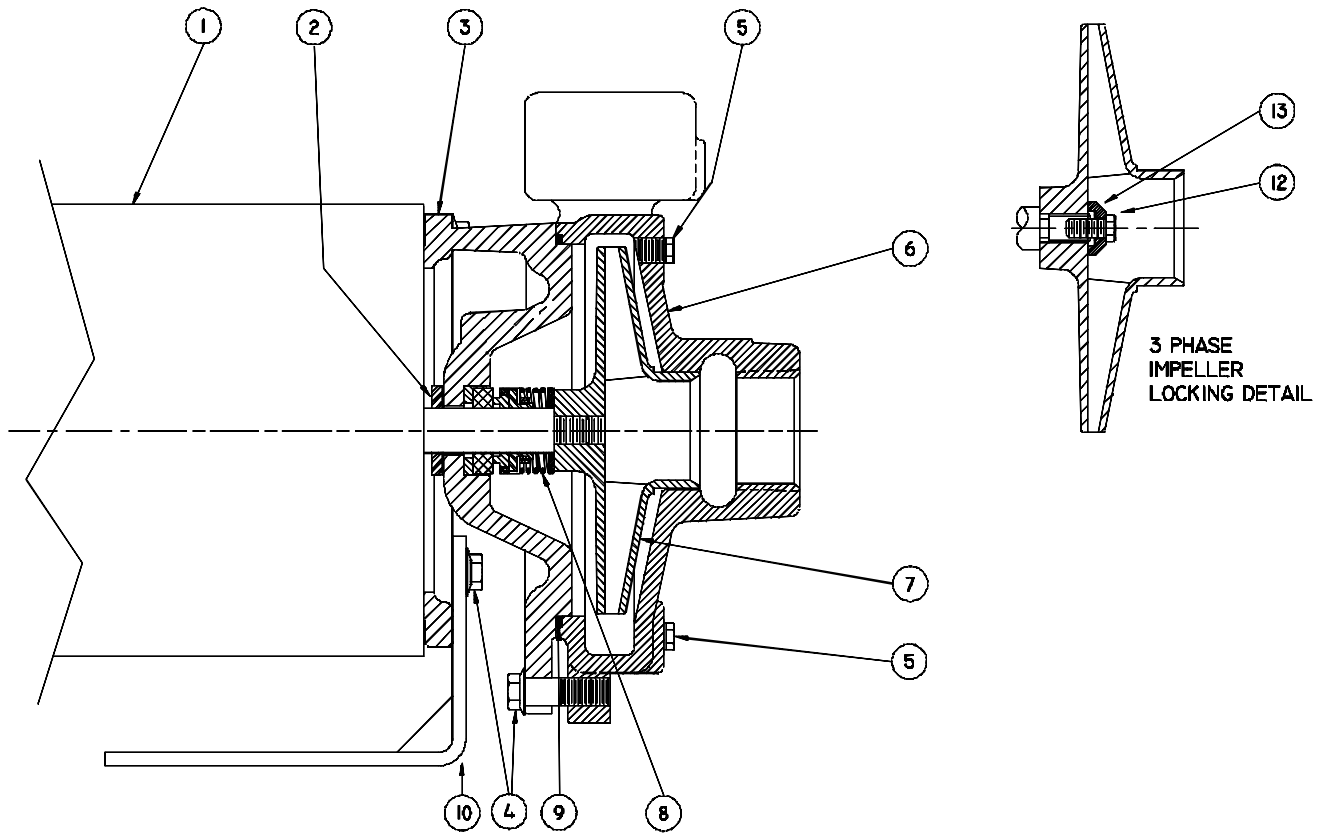

**SERIES: GA5-1-1/4 & GA6-1-1/4 CENTRIFUGAL PUMPS**

File: GA5-125.dwg

SYMBOL NUMBER	PART NUMBER	QUANTITY	DESCRIPTION
2	08105	1	Slinger
3	22752	1	Adapter - GA5-1-1/4
	22752-1	1	Tapped
	22754	1	Adapter - GA6-1-1/4
	22754-1	1	Tapped - GA6-1-1/4
4	21236	8	Cap Screw
5	00158	2	Pipe Plug - 1/8" Bronze
6	22766	1	Casing - GA5-1-1/4
	22766-1	1	Casing w/Flush Tap- GA5-1-1/4
	22767	1	Casing - GA6-1-1/4
	22767-1	1	Casing w/Flush Tap- GA5-1-1/4
7	09680-3.13	1	Impeller, Brass-3GA5-1-1/4
	09680-3.44	1	Impeller, Brass-5GA5-1-1/4
	09680-3.81	1	Impeller, Brass-7GA5-1-1/4
	09680-4.13	1	Impeller, Brass-10GA5-1-1/4
	09680-4.56	1	Impeller, Brass-15GA5-1-1/4
	09680-4.88	1	Impeller, Brass-20GA5-1-1/4
	09680-4.00	1	Impeller, Brass-10GA6-1-1/4
	09680-4.63	1	Impeller, Brass-15GA6-1-1/4
	09680-4.88	1	Impeller, Brass-20GA6-1-1/4
	09680-5.50	1	Impeller, Brass-30GA6-1-1/4
	21363-3.13	1	Impeller, Noryl-3GA5N-1-1/4
	21363-3.47	1	Impeller, Noryl-5GA5N-1-1/4
	21363-3.81	1	Impeller, Noryl-7GA5N-1-1/4
	21363-4.06	1	Impeller, Noryl-10GAN5-1-1/4
	21363-4.50	1	Impeller, Noryl-15GAN5-1-1/4
	21363-4.97	1	Impeller, Noryl-20GA5N-1-1/4
	21363-4.00	1	Impeller, Noryl-10GAN6-1-1/4
	21363-4.63	1	Impeller, Noryl-15GA6N-1-1/4
	21363-5.19	1	Impeller, Noryl-20GA6N-1-1/4
	21363-5.66	1	Impeller, Noryl-30GA6N-1-1/4
Stock Pump Catalog Numbers shown are for 1 phase units. Use Same Impellers for 3 phase units.			

SYMBOL NUMBER	PART NUMBER	QUANTITY	DESCRIPTION
8	08514	1	Mechanical Seal - Buna N (Std)
	09762	1	Mechanical Seal - Viton
	20764-C	1	Mechanical Seal - EPT*
<b>GA5-1-1/4 SERIES</b>			
9	21333	1	O-Ring Gasket - Buna N (Std)
	21546	1	O-Ring Gasket - Viton
	22132	1	O-Ring Gasket - EPT*
	22058	1	O-Ring Gasket - Teflon
	<b>GA6-1-1/4 SERIES</b>		
9	22021	1	O-Ring Gasket - Buna N (Std)
	22020	1	O-Ring Gasket - Viton
	22133	1	O-Ring Gasket - EPT*
	22102	1	O-Ring Gasket - Teflon
10	22751	1	Bracket
12	21182	1	Screw - S.S.
13	21181-C	1	Washer-Bronze
<b>DIFFERING PARTS FOR ALL BRONZE CONSTRUCTION</b>			
3	22752-A	1	Adapter-Bronze GA5-1-1/4AB
	22754-A	1	Adapter-Bronze GA6-1-1/4AB
5	01691-A	2	Pipe Plug, 1/8", Bronze
6	22766-A	1	Casing-Bronze GA5-1-1/4AB
	22767-A	1	Casing-Bronze GA6-1-1/4AB
<b>DIFFERING PARTS FOR ALL IRON CONSTRUCTION</b>			
5	00158	2	Pipe Plug - 1/8" Steel
7	09680-C	1	Impeller-Iron (size Suffixes same as standard bronze impellers)
13	21181-A	1	Washer-S.S.

\* For hot water or caustic service.

For technical advice or service please take your pump into your local pump service center.  
To order pump or parts or for pricing please go to the following links :

[Burks Pumps Home >>](#)

[Burks Pumps stock list >>](#)