

SECTION	2F
PAGE	1
ISSUED	2/03
REPLACES	12/01

CONDENSATE RETURN SYSTEMS

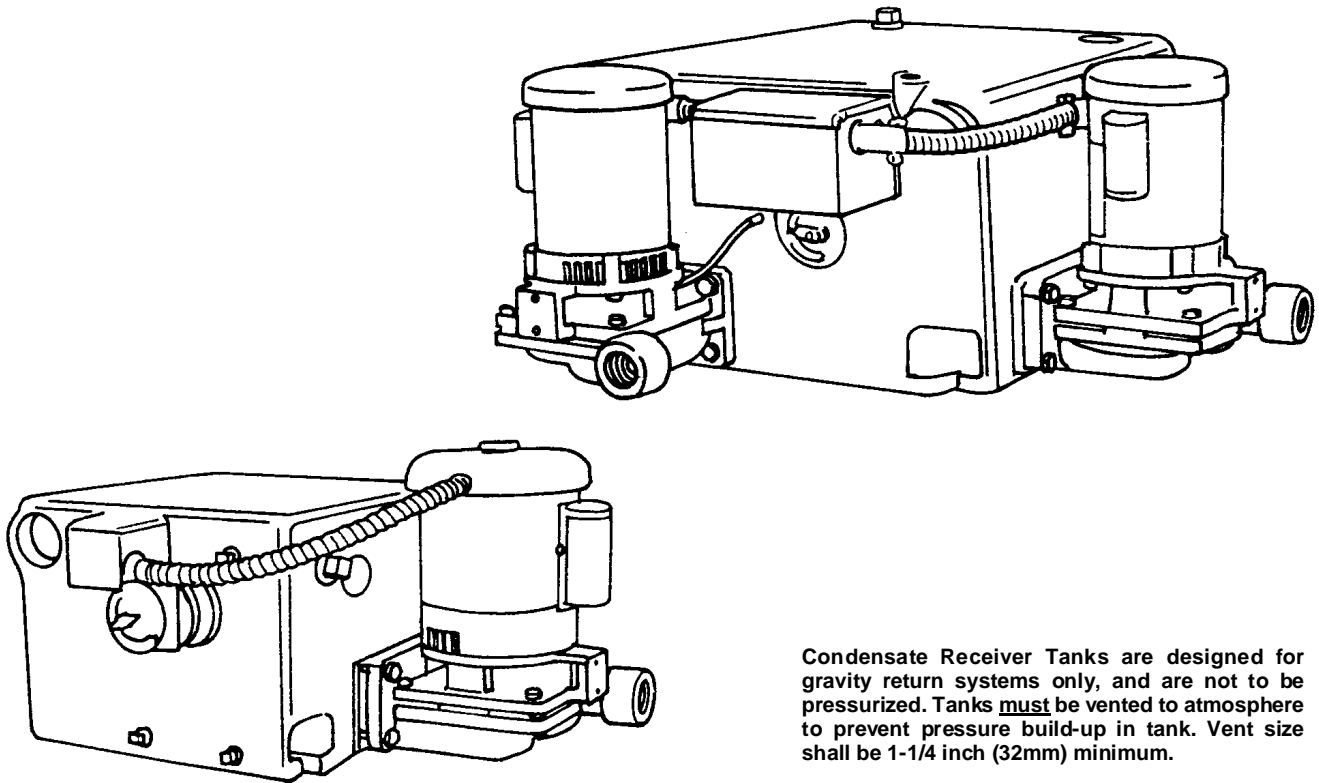

Condensate Receiver Tanks are designed for gravity return systems only, and are not to be pressurized. Tanks **must** be vented to atmosphere to prevent pressure build-up in tank. Vent size shall be 1-1/4 inch (32mm) minimum.

FEATURES

PUMPS

- Vertically flange-mounted centrifugal pumps are of bronze fitted construction with mechanical shaft seal for temperatures to 225°F (107°C).
- Seal area is automatically vented and flushed. Back pull-out design allows servicing without disturbing piping.
- Bronze impellers are precision balanced for smooth, quiet operation.
- Efficient hydraulic design for non-overloading performance at all ratings shown.

RECEIVER TANKS

- Rugged cast iron receivers for lifetime service under the most severe conditions. Low return inlet. Available in 9, 14, 20 and 36 gallon (34, 53, 87, and 136 Liters) sizes.
- Optional steel receiver available
- **EVERY** pump is factory tested.

MOTORS

- Drip-proof NEMA standard motors have dual ball bearings and threaded stainless steel shaft. All single phase motors have built-in overload protection. All three phase motors must be installed with a magnetic starter which provides full overload protection. Failure to use correct starter and overload protectors will void warranty.
- Single phase motors thru 2 HP are 115/230 Volt, 60 Hz. 3 HP is 230 Volt only.
- Three phase motors are 230/460 Volt, 60 Hz.

CONTROLS

- Simplex systems are equipped with a heavy duty adjustable float switch with stainless steel float and rod.
- Duplex systems are equipped with a mechanical alternator.

SECTION	2F
PAGE	2
ISSUED	2/03
REPLACES	12/01



SERIES GV CAST IRON CONDENSATE RETURN SYSTEMS PERFORMANCE AND SELECTION

Max. EDR Sq. Ft.	Equiv. Boiler H.P.	Max. GPM (Liters) Req'd.	Discharge Pressure PSIG (kpa)	Simplex Catalog No.	Duplex Catalog No.	Motor H.P.	Pump Discharge Size (NPT)	Receiver	
								Size Gals. (Liters)	Inlet Size (NPT)
6,000	40	9 (34)	10 (69)	3GV6-9	3GV6-14D	1/3	1 1/4"	9 (34) Simplex 14 (53) Duplex	2"
			20 (138)	5GV6-9	5GV6-14D	1/2			
			30 (207)	10GV6-9	10GV6-14D	1			
			40 (276)	20GV6-9	20GV6-14D	2			
			50 (345)	30GV6-9	30GV6-14D	3			
10,000	70	15 (57)	10 (69)	3GV6-14	3GV6-14D	1/3	1 1/4"	14 (53)	2"
			20 (138)	5GV6-14	5GV6-14D	1/2			
			30 (207)	10GV6-14	10GV6-14D	1			
			40 (276)	20GV6-14	20GV6-14D	2			
			50 (345)	30GV6-14	30GV6-14D	3			
15,000	100	22 1/2 (85.2)	10 (69)	3GV6-20	3GV6-20D	1/3	1 1/4"	20 (76)	2"
			20 (138)	5GV6-20	5GV6-20D	1/2			
			30 (207)	10GV6-20	10GV6-20D	1			
			40 (276)	20GV6-20	20GV6-20D	2			
			50 (345)	30GV6-20	30GV6-20D	3			
20,000	140	30 (114)	10 (69)	3GV6-36	3GV6-36D	1/3	1 1/4"	36 (136)	3"
			20 (138)	7GV6-36	7GV6-36D	3/4			
			30 (207)	10GV6-36	10GV6-36D	1			
			40 (276)	20GV6-36	20GV6-36D	2			
			50 (345)	30GV6-36	30GV6-36D	3			
30,000	215	45 (170)	10 (69)	3GV6-36	3GV6-36D	1/3	1 1/4"	36 (136)	3"
			20 (138)	7GV6-36	7GV6-36D	3/4			
			30 (207)	15GV6-36	15GV6-36D	1 1/2			
			40 (276)	20GV6-36	20GV6-36D	2			
			50 (345)	30GV6-36	30GV6-36D	3			
40,000	285	60 (227)	10 (69)	7GV6-36	7GV6-36D	3/4	1 1/4"	36 (136)	3"
			20 (138)	10GV6-36	10GV6-36D	1			
			30 (207)	20GV6-36	20GV6-36D	2			
			40 (276)	30GV6-36	30GV6-36D	3			
50,000	360	75 (284)	10 (69)	15GV6-36	15GV6-36D	1 1/2	1 1/4"	36 (136)	3"
			20 (138)	20GV6-36	20GV6-36D	2			
			30 (207)	30GV6-36	30GV6-36D	3			
			40 (276)	30GV6-36	30GV6-36D	3			

All selection are based on pump capacities of 1.5 gpm per 1000 sq. ft. of Equivalent Direct Radiation (EDR).

Catalog Numbers shown are for units with single phase motors.

For three phase, add prefix "3" to Catalog No. Example: 35GV6-9

For Steel Receiver, add suffix "-SR" to Catalog No., Example: 10GV6-36-SR

23, 36, 75, 120 gallon (87, 136, 284, 454 Liters) Steel Receivers Available, Contact Factory for Pricing and dimensions.



PUMPS & SYSTEMS

PumpAgents.com - buy pumps and parts online

SECTION	2F
PAGE	3
ISSUED	2/03
REPLACES	12/01

SERIES GV CAST IRON CONDENSATE RETURN SYSTEMS

DIMENSIONS - Inches (mm)

9 GAL. SYSTEMS

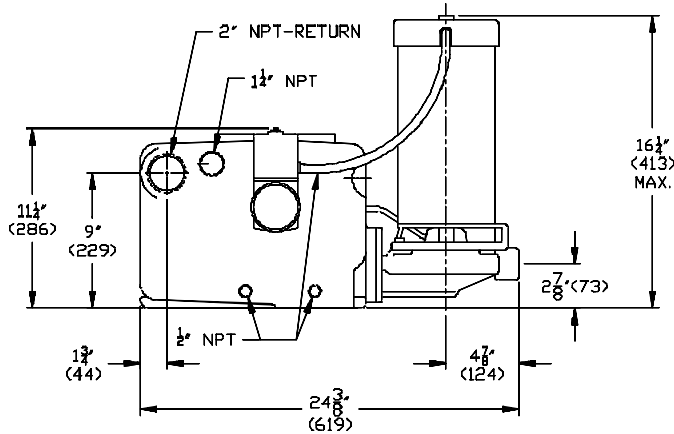
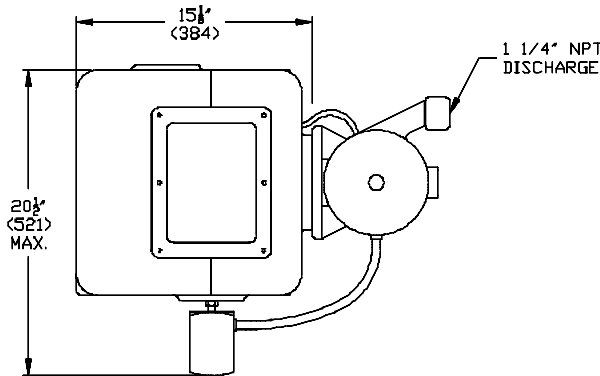

14 GAL. SYSTEMS

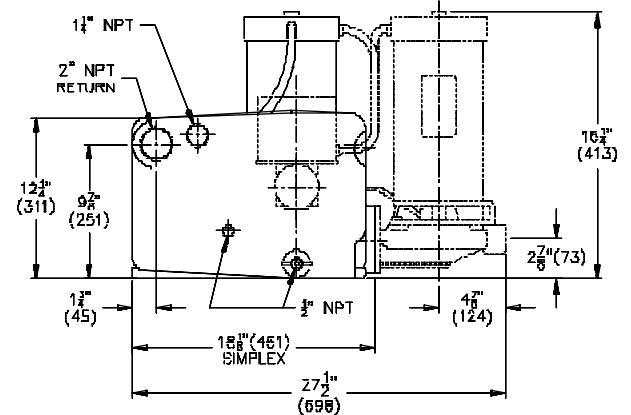
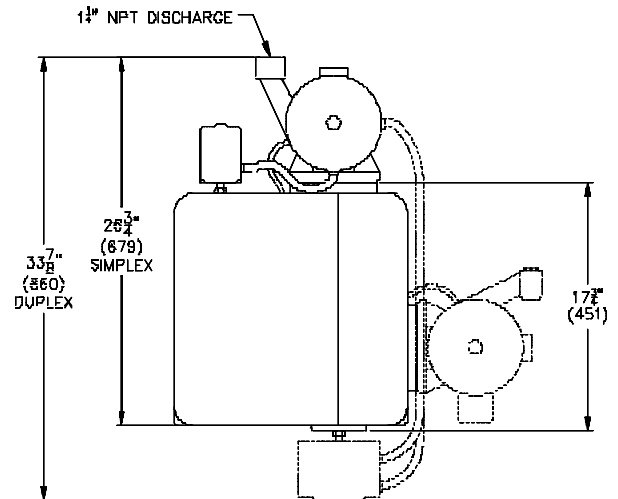

DIMENSIONS FOR STEEL RECEIVERS AVAILABLE ON REQUEST.

CRSP-98

1 - MOTORS (All 56J Frame)		
RPM & PHASE	PART NUMBER	HP
OPEN DRIP PROOF		
3500 RPM Single Phase (ODP)	09581	1/3
	09582	1/2
	09625	3/4
	09650	1
	09675	1-1/2
	09677	2
	09737	3
3500 RPM Three Phase (ODP)	09661	1/3
	09662	1/2
	09652	3/4
	09653	1
	09676	1-1/2
	09678	2
	09738	3
TOTALLY ENCLOSED		
3500 RPM Single Phase (TENV / TEFC)	09688	1/3
	09690	3/4
	09692	1
	09774	1-1/2
	09827	2
3500 RPM Three Phase (TENV / TEFC)	09689	1/2
	09691	3/4
	09693	1
	09758	1-1/2
	09829	2
	21697	3
EXPLOSION PROOF		
3500 RPM Single Phase (XP)	20655	1/2
	20513	3/4
	20515	1
	20517	1-1/2
	20519	2
3500 RPM Three Phase (XP)	20656	1/2
	20514	3/4
	20516	1
	20518	1-1/2
	20520	2
	09909	3



SERIES: GV CONDENSATE RETURN SYSTEMS & GV6 FLANGED PUMPS

File: GV.dwg

PumpAgents.com - Click here for Pricing/Ordering

SYMBOL NUMBER	PART NUMBER	QTY	DESCRIPTION
2	08105	1	Slinger Washer
3	08514	1	Mechanical Seal - Buna N
4	09657-1	1	Adapter
5	22021	1	O-ring Gasket - Buna N
6	22144	1	Receiver Tank - 9 gal. CI
	22145	1	Receiver Tank - 14 gal. CI
	22146	1	Receiver Tank - 23 gal. CI
	22339	1	Receiver Tank - 23 gal. Steel
	22147	1	Receiver Tank - 36 gal. CI
	22170	1	Receiver Tank - 36 gal. Steel
	22855	1	Receiver Tank - 52 gal. Steel
	22856	1	Receiver Tank - 75 gal. Steel
	22857	1	Receiver Tank - 120 gal. Steel
7	15-13-6	A/R	Nut
8	22234	A/R	Washer
9	09680-3.22	1	Impeller - 3GV6/33GV6
	09680-3.63	1	Impeller - 5GV6/35GV6
	09680-3.88	1	Impeller - 7GV6/37GV6
	09680-4.25	1	Impeller - 10GV6/310GV6
	09680-4.63	1	Impeller - 15GV6/315GV6
	09680-4.88	1	Impeller - 20GV6/320GV6
	09680-5.66	1	Impeller - 30GV6/330GV6
10	22016	1	Casing Assy. (Includes Symbol 11)
11	22019	1	Wear Ring
12	21182	1	Screw, Imp. Lock - 3PH Only
13	21181-C	1	Washer - 3PH
14	03122	4	Cap Screw
15	04235	A/R	Cap Screw

SYMBOL NUMBER	PART NUMBER	QTY	DESCRIPTION
16	22072	1	Cover
17	22018	A/R	Gasket, Pump to Tank
18	04177	1	Gasket - 23 & 36 Gal. Tanks
19	22161	1	Cover - 23 & 36 Gal. Tanks
20	01609-A	6	Washer - 23 & 36 Gal. Tanks
21	22167	1	Float Switch - Simplex
	22166	1	Mech. Alternator - Duplex
	22264	1	Mech. Alternator - Duplex XP
	22266	1	Float Switch - XP Simplex
	22265	1	Float Switch - Watertight Simplex
	22263	1	Mech. Alternator - Watertight Duplex
22	02313		Connector, Conduit - Straight
	01622	A/R	Connector, Conduit 90°
	01623		Connector, Conduit - 45°
23	S6518	A/R	Conduit (Specify Length)
24	22043	A/R	Tube
25	21222	A/R	Connector
Not Shown	22334	1	Float
Not Shown	B8283-1-E4	1	Plate, Switch - 20 Gal. Tanks
Not Shown	B8285-1-L13	1	Gasket, Plate - 20 Gal. Tanks
Not Shown	A5670-E4	A/R	Flange - 20 Gal. Tanks
Not Shown	A6579-L6	1	Gasket, Flange - 20 Gal. Tanks

For technical advice or service please take your pump into your local pump service center.
To order pump or parts or for pricing please go to the following links :

[Burks Pumps Home >>](#)

[Burks Pumps stock list >>](#)