

Please read and save this Repair Parts Manual. Read this manual and the General Operating Instructions carefully before attempting to assemble, install, operate or maintain the product described. Protect yourself and others by observing all safety information. The Safety Instructions are contained in the General Operating Instructions. Failure to comply with the safety instructions accompanying this product could result in personal injury and/or property damage! Retain instructions for future reference. AMT reserves the right to discontinue any model or change specifications at any time without incurring any obligation.

©2018 AMT Pump Company, A Subsidiary of The Gorman-Rupp Company, All Rights Reserved.

Periodic maintenance and inspection is required on all pumps to ensure proper operation. Unit must be clear of debris and sediment. Inspect for leaks and loose bolts. Failure to do so voids warranty.

Small Coolant Pumps

Suction and Immersion Models

Refer to pump manual 1808-634-00 for General Operating and Safety Instructions.



DESCRIPTION

These coolant pumps are the ideal replacement pumps for installation on machine tools. All units have cast iron construction, and feature stainless steel impellers. Pumps are equipped with a 3450 RPM motor with permanently lubricated bearings. They handle liquids with a maximum specific gravity of 1.0, maximum viscosity of 550 SSU, and maximum temperature of 180° F. For use with non-flammable liquids compatible with pump component materials. The motor on these pumps is not intended to be submerged in liquid.

IMMERSION-TYPE PUMPS:

For circulation of coolant and spraying of cutting oil in all machines, including grinders.

SUCTION-TYPE PUMPS:

May be mounted above the liquid level as well as other remote locations. Maximum suction lift is 2 feet. Pumps include a Buna-N elastomer shaft seal. For circulating coolant and spraying cutting oil in all types of machines, except grinders.

INSTALLATION

1. Install pump upright only, suction and discharge ports must be parallel to liquid surface.

NOTE: Suction-type pumps must be mounted above the liquid surface. Adding a low restriction foot valve to the suction line will enhance priming time. Both units are designed to drain away any liquid leaking past the shaft seal, to protect the motor. Provisions must be made to dispense any possible overflow.

NOTE: Immersion-type pumps must be installed with the liquid level at least 1 inch below the motor bottom.

2. Install pump and/or suction pipe a sufficient distance off the bottom of the coolant reservoir to prevent machining chips from entering the pump and damaging the pump and/or seal.
3. Install pump with a sufficient amount of liquid above the pump suction inlet to prevent drawing air into the pump.
4. Always mount the pump securely to a stable horizontal surface. Never rely on the piping to support the pump.
5. (Suction-type pumps only) Install a pipe tee in discharge line to fill the casing with liquid. Use a 90° elbow at discharge. Install Tee with long leg vertical. Vertical height of Tee from discharge port must be at least 18". Install plug in top vertical fill leg. Install discharge line into short horizontal leg of tee.

OPERATION

1. Suction-type pumps require initial priming. Do not run pump dry, damage to shaft seal will occur.

NOTE: Immersion-type pumps do not require priming and can be run dry.

2. Activate the unit. No controls are supplied with this unit.
3. Familiarize yourself and others with all controls and use of this pump. Learn how to stop pump/motor quickly in an emergency.

Maintenance

▲ WARNING

Make certain that the unit is disconnected from the power source before attempting to service or remove any component. Failure to do so could result in electrical shock.

1. Pump should be checked periodically (weekly, monthly) for proper operation, depending on hours of operation. If the system has changed since the pump was installed, or if the pump is operating noisily or erratically, then the pump should be removed and examined. It should be repaired and parts replaced as is necessary.

IMPELLER REPLACEMENT

(Refer to figure 1)

1. Disconnect the power supply.
2. Remove the pump assembly from the tank or reservoir.
3. Remove the volute or cover plate by removing the machine screws. Be careful not to damage gasket/o-ring (Suction-type pumps only).
4. Remove impeller screw and flat washer from the center of the impeller. It may be necessary to hold impeller or drive shaft to remove the impeller screw.
5. Impeller will slide off drive shaft. Some slight prying with a screwdriver may be required to break the impeller loose. Keep shims for reassembly.
6. Replace impeller by sliding onto drive shaft. Slot in impeller hub must line up with drive pin installed in drive shaft.
7. Install impeller screw and impeller washer. Spin impeller slowly by hand. If impeller rubs on machined surface, shim the impeller out in 0.010" increments until no rubbing is present. (Shims included with replacement impeller.)
8. Replace volute, or cover plate and gasket/o-ring (Suction-type pumps).
9. Secure to pump body with screws.

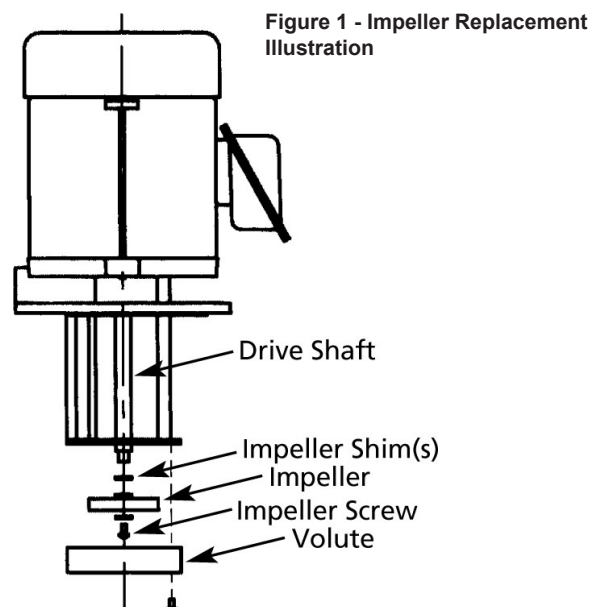

Small Coolant Pumps

SHAFT SEAL REPLACEMENT (SUCTION-TYPE PUMPS ONLY)

(Refer to figure 2)

REMOVAL OF OLD SEAL

1. Disconnect the power supply.
 2. Remove the pump assembly from the tank or reservoir.
 3. Remove impeller as described in "Impeller Replacement" section.
- NOTE: Remove fan cover and fan if motor is so equipped.
4. Remove screws holding motor body to pump body.
 5. Support pump body. Lightly tap on exposed ears of motor body until motor body is free from pump body.
 6. (Except 5340-95) Remove screws holding bearing retaining tabs to pump body.
 7. Lightly tap on end of drive shaft until lower bearing is dislodged from its bore. Remove drive shaft assembly from pump body.
 8. (5340-95 only) Remove shaft seal from its bore in pump body.
 9. (Except 5340-95) Remove seal seat from its seal cavity in pump body. Slide seal head off drive shaft.

INSTALLATION OF NEW SEAL

1. (5340-95 only) Clean seal cavity in pump body. Wet the outside diameter of the seal with soapy water. Squarely press new seal into bore until it is fully seated.
2. (Except 5340-95) Thoroughly clean seal seat cavity in pump body. Clean drive shaft.

▲ CAUTION

(Except 5340-95) *The precision lapped faces on the mechanical seal are easily damaged. Handle your replacement seal carefully. Do not touch the carbon/ ceramic seal faces.*

3. (Except 5340-95) Wet the rubber portion of the new seal seat with a light coating of soapy water. Use a clean cardboard washer of the same diameter as the seat to protect ceramic surface. With a piece of pipe or dowel rod firmly press the seal seat squarely into the bore until fully seated. Avoid scratching the white ceramic face.
4. (Except 5340-95) Dispose of cardboard washer. Check again to see that ceramic surface is free of dirt and all foreign particles.
5. (Except 5340-95) Wet inside diameter of seal head with soapy water. Slide seal head onto drive shaft until it seats.

NOTE: A short "run-in" period may be required to provide complete leakproof seal operation.

6. Replace drive shaft, take care not to damage seal when sliding drive shaft into pump body. Press drive shaft bearing into pump body.
7. (Except 5340-95) Replace bearing retaining tabs, fasten with screws.
8. Replace motor body onto drive shaft upper bearing until motor body is seated on pump body. Fasten with two screws.
9. Replace impeller as described in "Impeller Replacement" section.

NOTE: Replace fan and fan cover if motor is so equipped.

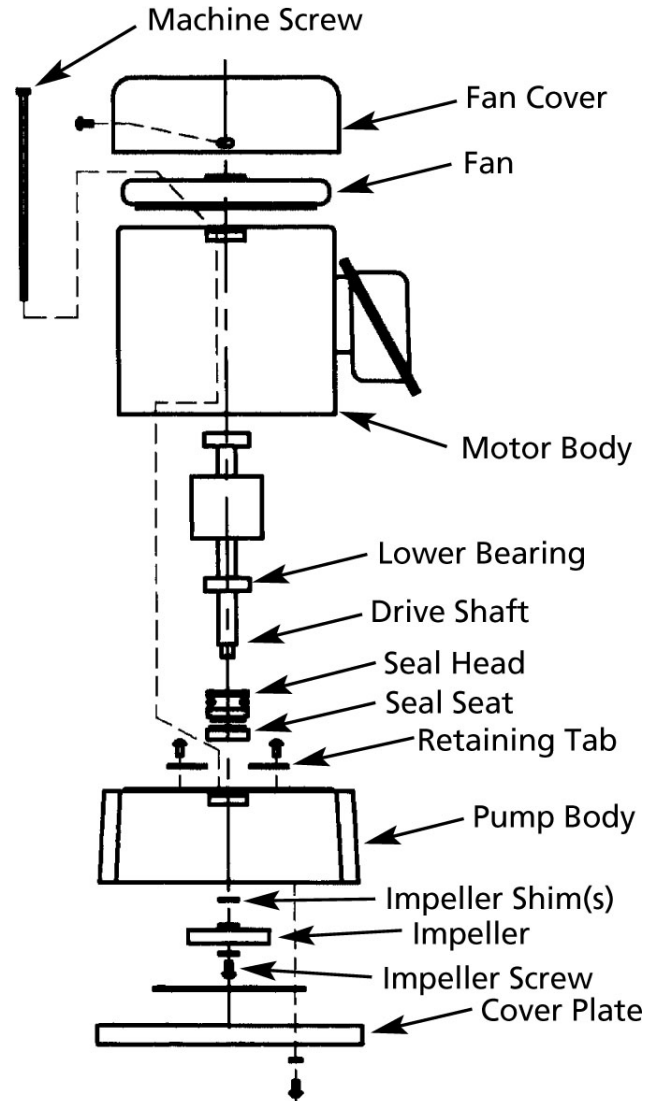

Figure 2 - Shaft Seal Replacement Illustration
(Suction-type pumps only)

Small Coolant Pumps

For Repair Parts contact dealer where pump was purchased.

Please provide following information:

-Model Number

-Serial Number (if any)

Part description and number as shown in parts list

Figure 3 - Repair Parts Illustrations for Suction-type pumps

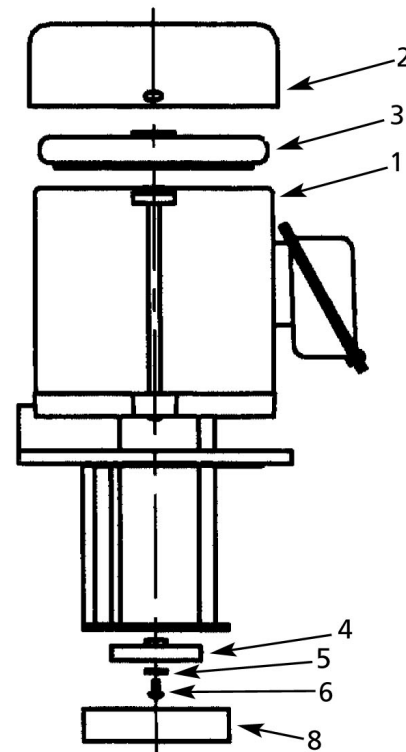
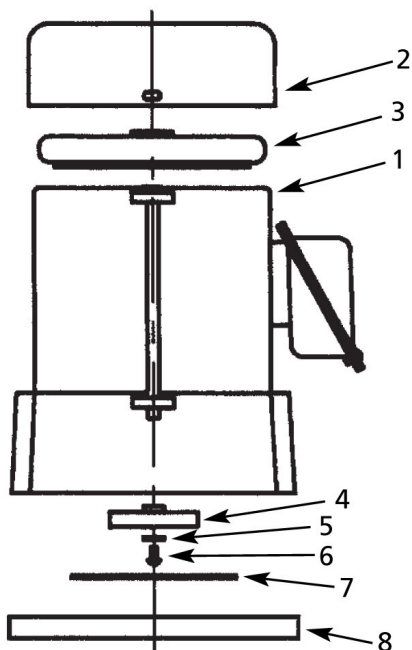

Figure 4- Repair Parts Illustrations for Immersion-type pumps

Repair Parts List

Ref	Description	Part Number for Models										Qty
		5340,5341 534A,534B	5350,5351 535A,535B	5380,5381 538A,538B	5390, 5391 539A,539B	5360,536A	5370, 537A	5371, 537B	5400, 540A	5410, 541A	5411, 541B	
1	Motor body 1PH	Replace Pump	Replace Pump	Replace Pump	Replace Pump	-	-	-	-	-	-	1
	Motor body 3PH	Replace Pump	Replace Pump	Replace Pump	Replace Pump	Replace Pump	Replace Pump	Replace Pump	Replace Pump	Replace Pump	Replace Pump	1
2	Fan cover	-	-	-	-	5360-121-00	5360-121-00	5360-121-00	5360-121-00	5360-121-00	5360-121-00	1
3	Fan	-	-	-	-	5360-120-00	5360-120-00	5360-120-00	5360-120-00	5360-120-00	5360-120-00	1
4	Impeller SS	5340-010-01	5350-010-01	5340-010-01	5350-010-01	5360-010-01	5370-010-01	5371-010-01	5360-010-01	5370-010-01	5371-010-01	1
5	Impeller washer	5340-400-00	5350-400-00	5340-400-00	5350-400-00	5350-400-00	5350-400-00	5350-400-00	5350-400-00	5350-400-00	5350-400-00	1
6	Impeller screw	5340-401-00	5350-401-00	5340-401-00	5350-401-00	5350-401-00	5350-401-00	5350-401-00	5350-401-00	5350-401-00	5350-401-00	1
7	Cover seal	5340-301-00	5350-301-00	-	-	5360-301-00	5370-301-00	5370-301-00	-	-	-	1
8	Cover	5340-020-00	5350-020-00	5380-020-00	5390-020-00	5360-020-00	5370-020-00	5370-020-00	5400-020-00	5410-020-00	5410-020-00	1
†	Shaft seal	5340-300-00	5350-160-00	-	-	5360-160-00	5360-160-00	5360-160-00	-	-	-	1

(†) Not shown, see figure 4