

WIRING DIAGRAM FOR MANUAL-AUTOMATIC OPERATION

3-WAY SWITCH
NO. 96070-0110
OR 44960-0000
OR 44960-0001

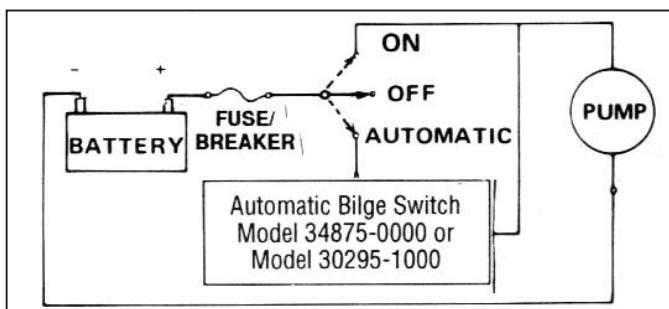

WIRING - AC VOLTAGE MODEL

Use 16 gauge standard copper wire for lengths up to 100 feet from power source. Connect the grounded, unswitched conductor (white) to the white motor lead. Connect the ungrounded switched conductor (black) to the black motor lead. This conductor should include, at the power source, a 1.5 amp 125 Volt fuse. The green motor lead must be connected to the AC circuit ground.

MINIMUM WIRE SIZES

Model Number	Voltage	Wire Size for Length of Run		Fuse/Breaker*
		1-25'	25-50'	
34600-0000	12 Vdc	12 AWG	10 AWG	15 amp
34600-0010	24 Vdc	14 AWG	14 AWG	8 amp
34600-0031	115 Vdc	16 AWG	16 AWG	1-1/2 amp

*Customer supplied, not included with pump.

MAINTENANCE

WINTER STORAGE:

When possible, it is preferred that the complete pump or at least motor, diaphragm and valves be removed and stored in a warm dry place. If this is not possible, the pump must be completely drained, hoses removed and pump run until all water is expelled.

SERVICE

DIAPHRAGM AND CONNECTING ROD REPLACEMENT

1. Remove four tie down bolts.
2. Lift jack shaft and the attached diaphragm assembly from pump base.
3. Remove two diaphragm retainer screws and the bottom diaphragm retainer.
4. Remove nut holding connecting rod to jackshaft. Remove connecting rod and diaphragm from the top diaphragm retainer, then unscrew bolt to separate diaphragm and plates.

5. Check diaphragm for cuts and cracks. Check rod assembly bearing for excessive wear. Replace if badly worn.
6. Loosely reassemble diaphragm, diaphragm plates, connecting rod spacer and diaphragm bolt onto connecting rod.
7. Firmly secure connecting rod to jack shaft with the lock nut. Secure diaphragm to upper diaphragm retainer with the bottom diaphragm retainer and two screws.
8. Tighten connecting rod bolt.
9. Replace motor-mount-diaphragm assembly and fasten evenly to base with the four tie down bolts and washers.

VALVE REPLACEMENT

1. Turn off power to pump. Remove four tie down bolts.
2. Expose valves by lifting jack shaft and attached diaphragm assembly from pump base. Remove and clean or replace valves.
3. Install valves, making sure rubber flapper is UP on intake and DOWN on discharge.
4. Replace motor-mount-diaphragm assembly and fasten evenly to base with the four tie down bolts and washers.

SURGE CHAMBER GASKET REPLACEMENT

1. Remove six surge chamber screws and lift off the surge chamber. Remove and replace two gaskets.
2. Replace the surge chamber and six screws. Tighten evenly to ensure an air and water seal.
3. Reinstall and reconnect power leads.

JABSCO MARINE SWITCH PANELS



44960-0000
LIGHTED SWITCH
W/BOOT SPDT

(DC APPLICATIONS ONLY)



44960-0001
UNLIGHTED
SPDT

(AC OR DC APPLICATIONS)

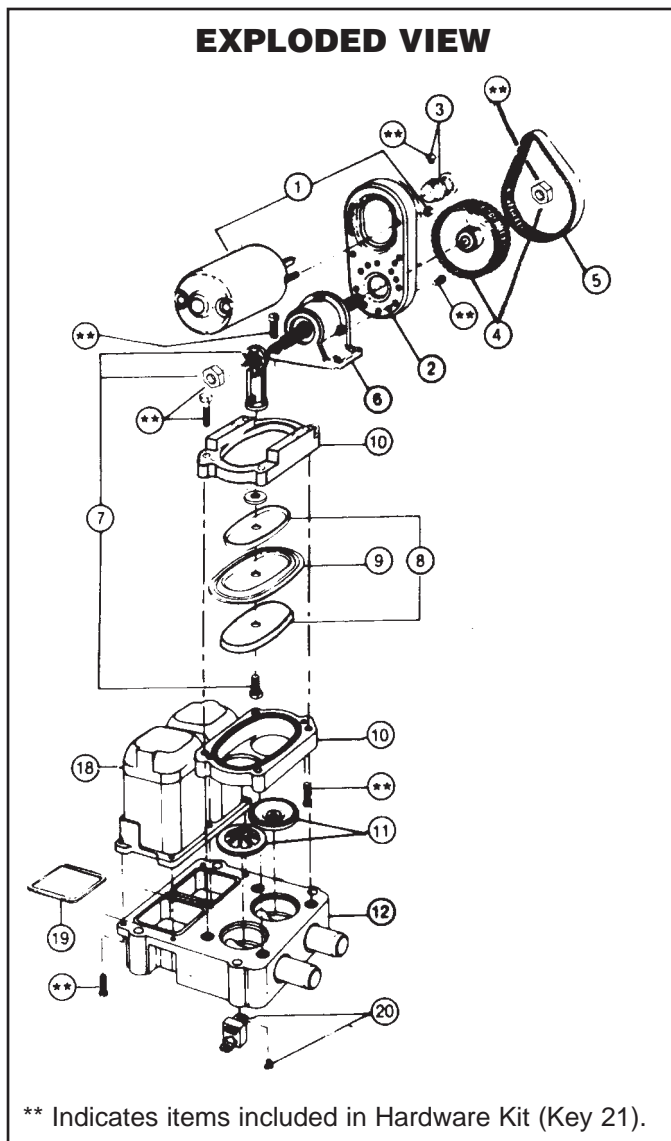
EXPLODED VIEW

** Indicates items included in Hardware Kit (Key 21).

PARTS LIST

Key	Description	Part Number	Qty.
1	Motor Kit 12 Volt dc	30200-0000	1
	Motor Kit 24 Volt dc	30200-0010	
	Motor Kit 115Volt ac.	30200-0031	
2	Motor Mount	34628-0000	1
3	Small Pulley	37169-0000	
4	Large Pulley	37170-0001	
5	Belt	30021-0000	1
6	Jack Shaft Assembly	35037-0001	-See note
7	Connecting Rod Kit	37172-0001	-See note
8	Diaphragm Plates	34640-0060	-Top 1
		34637-0000	
9	Diaphragm	30012-0000	1
10	Retainer	34633-0000	-Top 1
		34634-0000	-Bottom 1
11	Valve Set (inlet & outlet)	30002-0000	*† (set) 1
12	Base Assembly†	34623-0000	† (set) 1
18	Surge Chamber	34635-0000	
19	Gaskets	37181-0000	(set) 1
20	Vibration Pad Kit	37180-0000	† (set) 1
21	Hardware Kit Service Kit*	37164-0001	(set) 1
		30101-0000	

*Indicates parts contained in service kit.

† Indicates parts supplied with base assembly.

NOTE—Jack shaft assembly kit, with part number ending in -0001 includes new style connecting rod (37173-0001) with a 5/16" diameter hole and two (2) locknuts. Previous model pumps use a connecting rod (37173-0000) with a 1/4" diameter hole and a bolt.

TROUBLESHOOTING**Problem**

Loss of suction to pump

Solution

Air leak in suction line.
Bilge pickup not submerged.
Intake hose kinked or plugged.
Fouled intake or discharge valve.

Rough or noisy operation

Intake or discharge hose kinked or plugged.
Pump not mounted firmly.
Loosened eccentric screw.

DIMENSIONAL DRAWING
INCHES (MILLIMETERS)

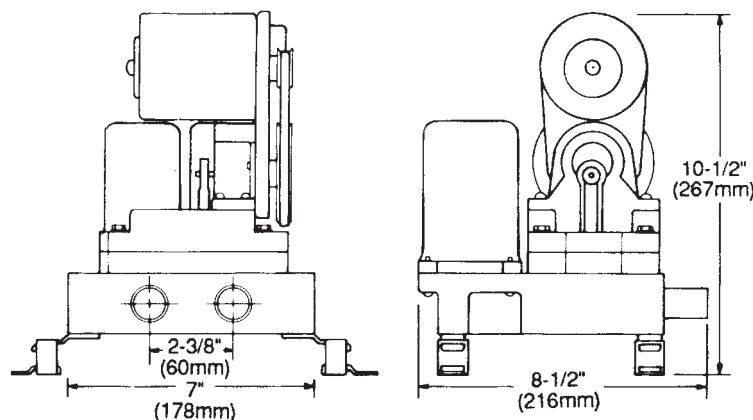

One Year Limited Warranty

A. LIMITED WARRANTY: ITT warrants that at the time of shipment, the products manufactured by ITT and sold hereunder shall be in conformity with applicable written specifications and descriptions referred to or set forth herein, free from defects in material and workmanship, merchantable, and suitable for a particular purpose, provided such is implied by State law under the circumstances of this sale.

B. WARRANTY ADJUSTMENT:

1. ITT agrees to repair or furnish a replacement for, but not to remove or install, any product or component thereof which, within one (1) year from date of purchase, shall upon test and examination by ITT prove defective within the above warranty. Receipt verifying purchase date is required to obtain adjustment.
2. Buyer shall notify ITT of any defect within this warranty no later than ninety (90) days after the defect is discovered.
3. No product will be accepted for return or replacement without the prior written authorization of ITT. Upon such authorization, and in accordance with instructions from ITT, the product will be returned to ITT, shipping charges prepaid by Buyer. Products returned to ITT will be addressed as follows:

ITT JABSCO
1485 Dale Way
Costa Mesa, California 92626-3998

Or to such alternate locations as may be designated on the product, its container, or this sheet.

Repair or replacement made under this warranty will be shipped prepaid to Buyer

C. EXCLUSIONS FROM WARRANTY AND LIMITATION OF LIABILITY:

1. The foregoing warranty is limited solely as set forth herein and applies only for the period designated above.

2. ITT SHALL NOT BE LIABLE FOR ANY LOSS, DAMAGE, SPECIAL OR CONSEQUENTIAL DAMAGE OF ANY KIND, WHETHER BASED UPON WARRANTY, CONTRACT, NEGLIGENCE, OR STRICT LIABILITY ARISING IN CONNECTION WITH THE SALE, USE, OR REPAIR OF THE PRODUCT.
3. THE MAXIMUM LIABILITY OF ITT IN CONNECTION WITH THIS WARRANTY SHALL NOT IN ANY CASE EXCEED THE CONTRACT PRICE FOR THE PRODUCT CLAIMED TO BE DEFECTIVE OR UNSUITABLE.
4. This warranty does not extend to any product manufactured by ITT which has been subjected to misuse, neglect, accident, improper installation, or use in violation of instructions furnished by ITT.
5. This warranty does not extend to or apply to any unit which has been repaired or altered at any place other than ITT's factory, or by persons not expressly approved by ITT, nor to any unit the serial number, model number, or identification of which has been removed, defaced or changed.
6. Components manufactured by any supplier other than ITT shall bear only that warranty made by the manufacturer of that product.
7. This warranty applies to products defined as "consumer products" by the Consumer Product Warranties Act as from time to time amended.

D. CONSUMER RIGHTS: This warranty gives you specific legal rights, and you may have other rights which vary from state to state. Some states do not allow exclusion or limitation of damages.

STANDARD WARRANTY: If the products manufactured and sold hereunder are not Consumer Products, the warranty extended to Buyer shall be as set forth in subparagraphs (A), (B), and (C), **EXCEPT THAT ALL EXPRESS OR IMPLIED WARRANTIES OR MERCHANTABILITY OR SUITABILITY FOR ANY PARTICULAR PURPOSE ARE EXCLUDED.**

Jabsco



ITT Industries
Engineered for life

PumpAgents.com - buy pumps and parts online

THE PRODUCTS DESCRIBED HEREIN ARE
SUBJECT TO THE JABSCO ONE YEAR LIMITED
WARRANTY, WHICH IS AVAILABLE FOR YOUR
INSPECTION UPON REQUEST.

For technical advice or service please take your pump into your local pump service center.
To order pump or parts or for pricing please go to the following links :

[Jabsco Pumps Home >>](#)

[Jabsco Pumps stock list >>](#)